



***Allen-Bradley***

## **SLC 500 Instruction Set**

**Catalog Numbers 1747-L20x,  
1747-L30x, 1747-L40x, 1747-L511,  
1747-L514, 1747-L524, 1747-L531,  
1747-L532, 1747-L533, 1747-L541,  
1747-L542, 1747-L543, 1747-L551,  
1747-L552, 1747-L553**

**Reference Manual**

**Rockwell  
Automation**

## Important User Information

Solid state equipment has operational characteristics differing from those of electromechanical equipment. Safety Guidelines for the Application, Installation and Maintenance of Solid State Controls, publication SGI-1.1, available from your local Rockwell Automation sales office or online at <http://www.literature.rockwellautomation.com>), describes some important differences between solid state equipment and hard-wired electromechanical devices. Because of this difference, and also because of the wide variety of uses for solid state equipment, all persons responsible for applying this equipment must satisfy themselves that each intended application of this equipment is acceptable.

In no event will Rockwell Automation, Inc. be responsible or liable for indirect or consequential damages resulting from the use or application of this equipment.

The examples and diagrams in this manual are included solely for illustrative purposes. Because of the many variables and requirements associated with any particular installation, Rockwell Automation, Inc. cannot assume responsibility or liability for actual use based on the examples and diagrams.

No patent liability is assumed by Rockwell Automation, Inc. with respect to use of information, circuits, equipment, or software described in this manual.

Reproduction of the contents of this manual, in whole or in part, without written permission of Rockwell Automation, Inc., is prohibited.

Throughout this manual, when necessary, we use notes to make you aware of safety considerations.

---

**WARNING**

Identifies information about practices or circumstances that can cause an explosion in a hazardous environment, which may lead to personal injury or death, property damage, or economic loss.

---

---

**IMPORTANT**

Identifies information that is critical for successful application and understanding of the product.

---

---

**ATTENTION**

Identifies information about practices or circumstances that can lead to personal injury or death, property damage, or economic loss. Attentions help you identify a hazard, avoid a hazard, and recognize the consequences.

---

---

**SHOCK HAZARD**

Labels may be located on or inside the equipment (for example, drive or motor) to alert people that dangerous voltage may be present.

---

---

**BURN HAZARD**

Labels may be located on or inside the equipment (for example, drive or motor) to alert people that surfaces may be dangerous temperatures.

---

## Summary of Changes

---

The information below summarizes the changes to this manual since the last printing.

To help you find new and updated information in this release of the manual, we have included change bars as shown next to this paragraph.

The table below lists the sections that document new features and additional or updated information about existing features.

<b>For This Information</b>	<b>See Page</b>
Addition of a powerup error to Table 16.1.	16-4
Revision of the company name from "Allen-Bradley" to "Rockwell Automation".	G-1

**Notes:**

<b>Preface</b>	<ul style="list-style-type: none"> <li>Who Should Use This Manual. . . . . P-1</li> <li>Purpose of This Manual. . . . . P-1               <ul style="list-style-type: none"> <li>Related Documentation. . . . . P-2</li> </ul> </li> <li>Common Techniques Used in This Manual. . . . . P-2</li> </ul>
<b>Chapter 1</b>	
<b>Processor Files</b>	<ul style="list-style-type: none"> <li>File Structure . . . . . 1-1               <ul style="list-style-type: none"> <li>Output and Input Data Files (Files O0: and I1:). . . . . 1-2</li> <li>Status File (File S2:). . . . . 1-3</li> <li>Bit Data File (B3:). . . . . 1-3</li> <li>Timer Data File (T4:). . . . . 1-4</li> <li>Addressing Structure . . . . . 1-5</li> <li>Counter Data File Elements (C5:). . . . . 1-6</li> <li>Entering Parameters . . . . . 1-7                   <ul style="list-style-type: none"> <li>Addressing Structure . . . . . 1-7</li> </ul> </li> <li>Control Data File (R6:). . . . . 1-8</li> <li>Integer Data File (N7:). . . . . 1-10</li> <li>Float Data File (F8:). . . . . 1-11</li> </ul> </li> </ul>
<b>Chapter 2</b>	
<b>Basic Instructions</b>	<ul style="list-style-type: none"> <li>About the Basic Instructions. . . . . 2-2</li> <li>Bit Instructions Overview . . . . . 2-2</li> <li>Examine if Closed (XIC). . . . . 2-3</li> <li>Examine if Open (XIO). . . . . 2-3</li> <li>Output Energize (OTE) . . . . . 2-4</li> <li>Output Latch (OTL) and Output Unlatch (OTU). . . . . 2-4               <ul style="list-style-type: none"> <li>Using OTL. . . . . 2-4</li> <li>Using OTU. . . . . 2-5</li> </ul> </li> <li>One-shot Rising (OSR) . . . . . 2-5               <ul style="list-style-type: none"> <li>Entering Parameters . . . . . 2-5</li> </ul> </li> <li>Timer Instructions Overview . . . . . 2-7               <ul style="list-style-type: none"> <li>Entering Parameters . . . . . 2-7</li> </ul> </li> <li>Timer On-delay (TON) . . . . . 2-9               <ul style="list-style-type: none"> <li>Using Status Bits . . . . . 2-9</li> </ul> </li> <li>Timer Off-delay (TOF) . . . . . 2-10               <ul style="list-style-type: none"> <li>Using Status Bits . . . . . 2-10</li> </ul> </li> <li>Retentive Timer (RTO) . . . . . 2-11               <ul style="list-style-type: none"> <li>Using Status Bits . . . . . 2-12</li> </ul> </li> <li>Counter Instructions Overview. . . . . 2-13               <ul style="list-style-type: none"> <li>How Counters Work. . . . . 2-13</li> </ul> </li> <li>Count Up (CTU) . . . . . 2-13               <ul style="list-style-type: none"> <li>Using Status Bits . . . . . 2-14</li> </ul> </li> <li>Count Down (CTD). . . . . 2-14               <ul style="list-style-type: none"> <li>Using Status Bits . . . . . 2-15</li> </ul> </li> <li>High-speed Counter (HSC). . . . . 2-15               <ul style="list-style-type: none"> <li>High-speed Counter Data Elements. . . . . 2-16</li> </ul> </li> </ul>

High-speed Counter Operation . . . . . 2-17  
 Reset (RES). . . . . 2-20

**Chapter 3**

**Comparison Instructions**

About the Comparison Instructions . . . . . 3-1  
 Comparison Instructions Overview . . . . . 3-2  
     Using Indexed Word Addresses . . . . . 3-2  
     Using Indirect Word Addresses . . . . . 3-2  
 Equal (EQU) . . . . . 3-2  
 Not Equal (NEQ) . . . . . 3-2  
 Less Than (LES). . . . . 3-3  
 Less Than or Equal (LEQ) . . . . . 3-3  
 Greater Than (GRT) . . . . . 3-3  
 Greater Than or Equal (GEQ) . . . . . 3-4  
 Masked Comparison for Equal (MEQ). . . . . 3-4  
     Entering Parameters . . . . . 3-4  
 Limit Test (LIM) . . . . . 3-5  
     Entering Parameters . . . . . 3-5

**Chapter 4**

**Math Instructions**

About the Math Instructions . . . . . 4-2  
 Math Instructions Overview . . . . . 4-2  
     Entering Parameters . . . . . 4-2  
     Using Indexed Word Addresses . . . . . 4-2  
     Using Indirect Word Addresses . . . . . 4-2  
     Updates to Arithmetic Status Bits . . . . . 4-3  
     Overflow Trap Bit, S:5/0 . . . . . 4-3  
     Updates to the Math Register, S:13 and S:14 . . . . . 4-3  
     Using Floating Point Data File (F8:). . . . . 4-4  
 Add (ADD). . . . . 4-5  
     Updates to Arithmetic Status Bits . . . . . 4-5  
 Subtract (SUB) . . . . . 4-5  
     Updates to Arithmetic Status Bits . . . . . 4-5  
 32-Bit Addition and Subtraction . . . . . 4-6  
     Math Overflow Selection Bit S:2/14. . . . . 4-6  
 Multiply (MUL) . . . . . 4-8  
     Updates to Arithmetic Status Bits . . . . . 4-8  
     Updates to the Math Register, S:13 and S:14 . . . . . 4-9  
 Divide (DIV) . . . . . 4-9  
     Updates to Arithmetic Status Bits . . . . . 4-9  
     Updates to the Math Registers, S:13 and S:14 . . . . . 4-10  
 Double Divide (DDV). . . . . 4-11  
     Updates to Arithmetic Status Bits . . . . . 4-11  
     Updates to the Math Registers, S:13 and S:14 . . . . . 4-11  
 Clear (CLR). . . . . 4-12

---

Updates to Arithmetic Status Bits . . . . .	4-12
Square Root (SQR) . . . . .	4-12
Updates to Arithmetic Status Bits . . . . .	4-12
Scale with Parameters (SCP) . . . . .	4-13
Entering Parameters . . . . .	4-13
Updates to Arithmetic Status Bits . . . . .	4-14
Application Examples . . . . .	4-14
Scale Data (SCL) . . . . .	4-15
Entering Parameters . . . . .	4-16
Updates to Arithmetic Status Bits . . . . .	4-16
Application Example 1 - Converting 4 to 20 mA Analog Input Signal to PID Process Variable . . . . .	4-17
Application Example 2 - Scaling an Analog Input to Control an Analog Output . . . . .	4-18
Ramp Instruction (RMP) . . . . .	4-20
Instruction Operation . . . . .	4-22
RMP Equation . . . . .	4-23
Continuous Operation . . . . .	4-23
Absolute (ABS) . . . . .	4-24
Entering Parameters . . . . .	4-24
Updates to Arithmetic Status Bits . . . . .	4-24
Compute (CPT) . . . . .	4-25
Entering Parameters . . . . .	4-25
Updates to Arithmetic Status Bits . . . . .	4-26
Application Example . . . . .	4-26
Swap (SWP) . . . . .	4-28
Entering Parameters . . . . .	4-28
Arc Sine (ASN) . . . . .	4-29
Updates to Arithmetic Status Bits . . . . .	4-29
Arc Cosine (ACS) . . . . .	4-29
Updates to Arithmetic Status Bits . . . . .	4-29
Arc Tangent (ATN) . . . . .	4-30
Updates to Arithmetic Status Bits . . . . .	4-30
Cosine (COS) . . . . .	4-30
Updates to Arithmetic Status Bits . . . . .	4-30
Natural Log (LN) . . . . .	4-31
Updates to Arithmetic Status Bits . . . . .	4-31
Log to the Base 10 (LOG) . . . . .	4-31
Updates to Arithmetic Status Bits . . . . .	4-31
Sine (SIN) . . . . .	4-32
Updates to Arithmetic Status Bits . . . . .	4-32
Tangent (TAN) . . . . .	4-32
Updates to Arithmetic Status Bits . . . . .	4-32
X to the Power of Y (XPY) . . . . .	4-33
Updates to Arithmetic Status Bits . . . . .	4-33

<b>Data Handling Instructions</b>	<b>Chapter 5</b>
	Convert to BCD (TOD) . . . . . 5-2
	Updates to Arithmetic Status Bits . . . . . 5-2
	Updates to the Math Register, S:13 and S:14 . . . . . 5-3
	Convert from BCD (FRD) . . . . . 5-5
	Updates to Arithmetic Status Bits . . . . . 5-5
	Changes to the Math Register, S:13 and S:14 . . . . . 5-6
	Radian to Degrees (DEG) . . . . . 5-8
	Entering Parameters . . . . . 5-8
	Updates to Arithmetic Status Bits . . . . . 5-9
	Degrees to Radians (RAD) . . . . . 5-9
	Entering Parameters . . . . . 5-9
	Updates to Arithmetic Status Bits . . . . . 5-10
	Decode 4 to 1 of 16 (DCD) . . . . . 5-10
	Entering Parameters . . . . . 5-11
	Encode 1 of 16 to 4 (ENC) . . . . . 5-11
	Entering Parameters . . . . . 5-12
	Updates to Arithmetic Status Bits . . . . . 5-12
	Copy File (COP) and Fill File (FLL) Instructions . . . . . 5-13
	Using COP . . . . . 5-13
	Using FLL . . . . . 5-14
	Move and Logical Instructions Overview . . . . . 5-16
	Entering Parameters . . . . . 5-16
	Using Indexed Word Addresses . . . . . 5-16
	Updates to Arithmetic Status Bits . . . . . 5-16
	Using Indirect Word Addresses . . . . . 5-16
	Updates to the Math Register, S:13 and S:14 . . . . . 5-17
	Entering Mask Values . . . . . 5-17
	Move (MOV) . . . . . 5-17
	Entering Parameters . . . . . 5-17
	Updates to Arithmetic Status Bits . . . . . 5-17
	Masked Move (MVM) . . . . . 5-18
	Entering Parameters . . . . . 5-18
	Updates to Arithmetic Status Bits . . . . . 5-18
	And (AND) . . . . . 5-20
	Updates to Arithmetic Status Bits . . . . . 5-20
	Or (OR) . . . . . 5-21
	Updates to Arithmetic Status Bits . . . . . 5-21
	Exclusive Or (XOR) . . . . . 5-22
	Updates to Arithmetic Status Bits . . . . . 5-22
	Not (NOT) . . . . . 5-23
	Updates to Arithmetic Status Bits . . . . . 5-23
	Negate (NEG) . . . . . 5-24
	Updates to Arithmetic Status Bits . . . . . 5-24
	FIFO and LIFO Instructions Overview . . . . . 5-25
	Entering Parameters . . . . . 5-25



	Effects on Index Register S:24 . . . . .	5-26
	FIFO Load (FFL) and FIFO Unload (FFU) . . . . .	5-26
	FFL Instruction Operation . . . . .	5-27
	FFU Instruction Operation . . . . .	5-27
	LIFO Load (LFL) and LIFO Unload (LFU) . . . . .	5-28
	LFL Instruction Operation . . . . .	5-29
	LFU Instruction Operation . . . . .	5-29
	<b>Chapter 6</b>	
<b>Program Flow Instructions</b>	About the Program Flow Control Instructions . . . . .	6-1
	Jump to Label (JMP) and Label (LBL) . . . . .	6-2
	Entering Parameters . . . . .	6-2
	Using JMP . . . . .	6-2
	Using LBL . . . . .	6-3
	Jump to Subroutine (JSR), Subroutine (SBR), and Return (RET) . . . . .	6-3
	Nesting Subroutine Files . . . . .	6-4
	Using JSR . . . . .	6-4
	Using SBR . . . . .	6-5
	Using RET . . . . .	6-5
	Master Control Reset (MCR) . . . . .	6-6
	Processor Operation . . . . .	6-6
	Temporary End (TND) . . . . .	6-7
	Suspend (SUS) . . . . .	6-8
	Entering Parameters . . . . .	6-8
	Immediate Input with Mask (IIM) . . . . .	6-8
	Entering Parameters . . . . .	6-8
	Immediate Output with Mask (IOM) . . . . .	6-9
	Entering Parameters . . . . .	6-9
	I/O Refresh (REF) . . . . .	6-10
	Using an SLC 5/02 Processor . . . . .	6-10
	Using SLC 5/03 and Higher Processors . . . . .	6-10
	<b>Chapter 7</b>	
<b>Application Specific Instructions</b>	About the Application Specific Instructions . . . . .	7-2
	Bit Shift Instructions Overview . . . . .	7-2
	Entering Parameters . . . . .	7-2
	Effects on Index Register S:24 . . . . .	7-4
	Bit Shift Left (BSL)	
	Bit Shift Right (BSR) . . . . .	7-4
	Use BSL . . . . .	7-4
	Use BSR . . . . .	7-5
	Sequencer Instructions Overview . . . . .	7-5
	Effects on Index Register S:24 . . . . .	7-5
	Applications Requiring More than 16 Bits . . . . .	7-6

Sequencer Output (SQO)  
 Sequencer Compare (SQC) ..... 7-6  
     Enter Parameters ..... 7-6  
     Use SQO ..... 7-8  
     Use SQC ..... 7-10  
 Sequencer Load (SQL) ..... 7-12  
     Enter Parameters ..... 7-12  
     Operation ..... 7-14  
 Read High-speed Clock and Compute Time Difference Overview 7-15  
     RHC Instruction Operation ..... 7-15  
     TDF Instruction Operation ..... 7-16  
 Read High-speed Clock Instruction (RHC) ..... 7-17  
     Enter Parameters ..... 7-17  
 Compute Time Difference Instruction (TDF) ..... 7-17  
     Enter Parameters ..... 7-17  
 File Bit Comparison (FBC) and Diagnostic Detect (DDT) ..... 7-18  
     Select the Search Mode ..... 7-18  
     Enter Parameters ..... 7-20  
     Use Status Bits ..... 7-21  
 Read Program Checksum (RPC) ..... 7-23  
     Enter Parameters ..... 7-23

**Chapter 8**

**Block Transfer Instructions**

Block Transfer Instructions (BTR and BTW) ..... 8-1  
 RIO Block Transfer General Functional Overview ..... 8-2  
 Entering Parameters for BTR and BTW ..... 8-2  
 Control Status Bits ..... 8-3  
 Instruction Operation ..... 8-7  
 Programming Examples ..... 8-8  
 Comparison to the PLC-5 BTR and BTW ..... 8-11

**Chapter 9**

**Proportional Integral Derivative Instruction**

Overview ..... 9-1  
 The PID Concept ..... 9-1  
 The PID Equation ..... 9-2  
 The PID Instruction ..... 9-3  
     Entering Parameters ..... 9-3  
 PID Control Block Layout ..... 9-5  
     Controller Gain (Kc) ..... 9-6  
     Reset Term (Ti) ..... 9-6  
     Rate Term (Td) ..... 9-7  
     Feed Forward/Bias ..... 9-7  
     Mode (TM) ..... 9-7  
     Loop Update ..... 9-8  
     Deadband ..... 9-8

Scaled Error . . . . .	9-9
Auto / Manual (AM) . . . . .	9-9
Control (CM) . . . . .	9-10
Deadband (DB) . . . . .	9-10
Reset and Gain Enhancement Bit (RG) . . . . .	9-10
Setpoint Scaling (SC) . . . . .	9-11
Loop Update Time Too Fast (TF) . . . . .	9-11
Derivative Rate Action Bit (DA) . . . . .	9-12
Output Alarm Upper Limit (UL) . . . . .	9-12
Output Alarm Lower Limit (LL) . . . . .	9-12
Setpoint Out Of Range (SP) . . . . .	9-13
PV Out Of Range (PV) . . . . .	9-13
PID Done (DN) . . . . .	9-13
PID Rational Approximation Bit (RA) . . . . .	9-14
PID Enable (EN) . . . . .	9-14
Integral Sum . . . . .	9-14
Input Parameters . . . . .	9-15
Setpoint (SP) . . . . .	9-15
Scaled Process Variable (SPV) . . . . .	9-16
Setpoint Maximum Scaled (SMAX) . . . . .	9-16
Setpoint Minimum Scaled (SMIN) . . . . .	9-17
Output Parameters . . . . .	9-18
Control Variable (CV) . . . . .	9-18
Control Variable Percent (CV%) . . . . .	9-19
Output Limiting Enable (OL) . . . . .	9-19
Output Maximum (CVH) . . . . .	9-20
Output Minimum (CVL) . . . . .	9-20
Runtime Errors . . . . .	9-21
PID and Analog I/O Scaling . . . . .	9-23
Using the SCL Instruction . . . . .	9-24
Using the SCP Instruction . . . . .	9-24
Application Notes . . . . .	9-27
Input/Output Ranges . . . . .	9-27
Scaling to Engineering Units . . . . .	9-27
Output Alarms . . . . .	9-28
Output Limiting with Anti-Reset Windup . . . . .	9-29
The Manual Mode . . . . .	9-29
PID Rungstate . . . . .	9-30
Time Proportioning Outputs . . . . .	9-30

## Chapter 10

### ASCII Instructions

ASCII Instruction Overview . . . . .	10-2
Protocol Parameter Overview . . . . .	10-2
Entering Parameters . . . . .	10-5
Test ASCII Buffer for Line (ABL) . . . . .	10-6
Entering Parameters . . . . .	10-6

Number of ASCII Characters In Buffer (ACB) .....	10-7
Entering Parameters .....	10-7
String to Integer (ACI) .....	10-8
ASCII Clear Receive and/or Transmit Buffer (ACL) .....	10-9
Entering Parameters .....	10-10
String Concatenate (ACN) .....	10-11
Entering Parameters .....	10-11
String Extract (AEX) .....	10-12
Entering Parameters .....	10-12
ASCII Handshake Lines (AHL) .....	10-13
Entering Parameters .....	10-13
Integer to String (AIC) .....	10-14
ASCII Read Characters (ARD) .....	10-15
Entering Parameters .....	10-15
Timing Diagram for a Successful ARD, ARL, AWA, and AWT Instructions .....	10-16
ASCII Read Line (ARL) .....	10-17
Entering Parameters .....	10-17
String Search (ASC) .....	10-18
Entering Parameters .....	10-18
ASCII String Compare (ASR) .....	10-19
Entering Parameters .....	10-19
ASCII Write with Append (AWA) .....	10-20
Entering Parameters .....	10-20
Using Inline Indirection .....	10-21
ASCII Write (AWT) .....	10-22
Entering Parameters .....	10-22
ASCII Instruction Error Codes .....	10-24
ASCII Conversion Table .....	10-25

## Chapter 11

### Understanding Interrupt Routines

User Fault Routine Overview .....	11-2
Status File Data Saved .....	11-3
Creating a User Fault Subroutine .....	11-3
User Interrupt Routine Application Example .....	11-4
Selectable Timed Interrupt Overview .....	11-8
Basic Programming Procedure for the STI Function .....	11-8
Operation .....	11-9
STI Subroutine Content .....	11-9
Interrupt Latency and Interrupt Occurrences .....	11-9
Interrupt Priorities .....	11-11
Status File Data Saved .....	11-11
STI Parameters .....	11-12
STD and STE Instructions .....	11-16
Selectable Timed Disable - STD .....	11-16
Selectable Timed Enable - STE .....	11-16

STD/STE Zone Example . . . . .	11-16
Selectable Timed Start (STS) . . . . .	11-17
Discrete Input Interrupt Overview . . . . .	11-18
Basic Programming Procedure for the DII Function . . . . .	11-18
Operation . . . . .	11-19
Counter Mode . . . . .	11-19
Event Mode . . . . .	11-20
DII Subroutine Content . . . . .	11-20
Interrupt Latency and Interrupt Occurrences . . . . .	11-21
Interrupt Priorities . . . . .	11-22
Status File Data Saved . . . . .	11-22
Reconfigurability . . . . .	11-22
DII Parameters . . . . .	11-23
Discrete Input Interrupt Application Example . . . . .	11-25
I/O Interrupt Overview (ISR) . . . . .	11-27
Basic Programming Procedure for the I/O Interrupt Function . . . . .	11-27
Operation . . . . .	11-27
Interrupt Subroutine (ISR) Content . . . . .	11-28
Interrupt Latency and Interrupt Occurrences . . . . .	11-28
Interrupt Priorities . . . . .	11-29
Status File Data Saved . . . . .	11-30
I/O Interrupt Parameters . . . . .	11-30
I/O Interrupt Disable (IID) and I/O Interrupt Enable (IIE) . . . . .	11-32
IID Operation . . . . .	11-32
IIE Operation . . . . .	11-33
IID/IIE Zone Example . . . . .	11-33
Reset Pending Interrupt (RPI) . . . . .	11-34
Entering Parameters . . . . .	11-34
Interrupt Subroutine (INT) . . . . .	11-34

## Chapter 12

### SLC Communication Instructions

About the Communication Instructions . . . . .	12-2
Service Communications (SVC) . . . . .	12-3
Use an SLC 5/02 Processor . . . . .	12-3
Use SLC 5/03 and Higher Processors . . . . .	12-3
Channel Servicing . . . . .	12-4
Message Instruction Overview . . . . .	12-5
MSG Instruction Operation . . . . .	12-5
MSG Instruction Configuration Options . . . . .	12-11
MSG Instruction Parameters . . . . .	12-11
MSG Instruction Setup Screen Parameters . . . . .	12-13
MSG Instruction Setup Screen Status Bits . . . . .	12-27
MSG Instruction Control Block . . . . .	12-30
Status Bit Sequencing for SLC 5/03, SLC 5/04, and SLC 5/05 MSG Instruction . . . . .	12-37

Rung Goes True. . . . .	12-37
Next End of Scan . . . . .	12-39
Successful Receipt of Packet. . . . .	12-39
An ACK is Not Received . . . . .	12-40
Target Node Sends a Reply Packet. . . . .	12-40
MSG Instruction Error Codes. . . . .	12-41
Explicit Message Instruction Overview . . . . .	12-44
ControlNet Explicit Message (CEM) . . . . .	12-45
CEM Instruction Parameters . . . . .	12-45
CEM Instruction Setup Screen Parameters . . . . .	12-46
DeviceNet Explicit Message (DEM). . . . .	12-52
DEM Instruction Parameters . . . . .	12-52
DEM Instruction Setup Screen Parameters . . . . .	12-52
EtherNet/IP Explicit Message (EEM) . . . . .	12-58
EEM Instruction Parameters . . . . .	12-58
EEM Instruction Setup Screen Parameters . . . . .	12-58

### Chapter 13

## SLC Communication Channels

Communication Driver Overview. . . . .	13-2
DH-485 Communications . . . . .	13-4
DH-485 Network Protocol . . . . .	13-4
DH-485 Network Considerations. . . . .	13-5
Configuring a Channel for DH-485 . . . . .	13-7
DH-485 Channel Status. . . . .	13-9
Data Highway Plus Communications . . . . .	13-10
Configuring Channel 1 for DH+ . . . . .	13-12
DH+ Channel Status. . . . .	13-13
Global Status Word Overview . . . . .	13-18
Ethernet Communications. . . . .	13-22
SLC 5/05 Performance Considerations . . . . .	13-22
SLC 5/05 and PC Connections to the Ethernet Network . . . . .	13-23
Configuring Channel 1 for Ethernet. . . . .	13-24
Ethernet Channel Status . . . . .	13-28
Configuration Via BOOTP . . . . .	13-31
Using the Rockwell BOOTP Utility . . . . .	13-33
SLC 5/05 Embedded Web Server Capability. . . . .	13-35
Module Information . . . . .	13-35
TCP/IP Configuration . . . . .	13-36
Diagnostic Information. . . . .	13-37
Data Table Memory Map . . . . .	13-38
Data Table Monitor. . . . .	13-40
User Provided Pages . . . . .	13-41
DF1 Full-duplex Communications . . . . .	13-49
Configuring Channel 0 for DF1 Full-duplex . . . . .	13-49
DF1 Full-duplex Channel Status. . . . .	13-53

DF1 Half-duplex Communications . . . . .	13-55
DF1 Half-duplex Master Broadcast . . . . .	13-55
DF1 Half-duplex Slave Broadcast . . . . .	13-55
Configuring Channel 0 for Standard Polling Mode DF1	
Half-duplex Master . . . . .	13-56
Minimum DF1 Half-duplex Master Channel 0 ACK Timeout	13-61
Determining Minimum Master ACK Timeout . . . . .	13-62
Monitor Active Stations . . . . .	13-63
Configuring Channel 0 for Message-based Polling Mode DF1	
Half-duplex Master . . . . .	13-63
DF1 Half-duplex Master Channel Status . . . . .	13-68
Configuring Channel 0 for DF1 Half-duplex Slave . . . . .	13-69
Configuring Channel 0 Poll Timeout . . . . .	13-73
DF1 Half-duplex Slave Channel Status . . . . .	13-74
DF1 Radio Modem Communications . . . . .	13-76
DF1 Radio Modem System Limitations . . . . .	13-77
Configuring Channel 0 for DF1 Radio Modem . . . . .	13-78
DF1 Radio Modem Channel Status . . . . .	13-81
Configuring the Store & Forward Table . . . . .	13-82
Using Modems that Support DF1 Communication Protocols . . . . .	13-84
Dial-up Phone Modems . . . . .	13-84
Leased-line Modems . . . . .	13-84
Radio Modems . . . . .	13-85
Line Drivers . . . . .	13-85
Modem Control Line Operation in SLC 5/03, SLC 5/04 and	
SLC 5/05 Processors . . . . .	13-86
DF1 Full-duplex . . . . .	13-86
DF1 Half-duplex Slave . . . . .	13-86
DF1 Half-duplex Master . . . . .	13-87
DF1 Radio Modem . . . . .	13-88
Modbus RTU Master . . . . .	13-88
RTS Send Delay and RTS Off Delay Parameters . . . . .	13-89
Modbus RTU Protocol . . . . .	13-90
Modbus RTU Master . . . . .	13-90
Configuring a Channel for Modbus RTU Master . . . . .	13-91
Modbus RTU Master Channel Status . . . . .	13-94
Modbus Commands . . . . .	13-96
Modbus Error Codes . . . . .	13-97
ASCII Communications . . . . .	13-98
Configuring Channel 0 for ASCII Communications . . . . .	13-98

## Chapter 14

### SLC Passthru Communications

Remote I/O Passthru . . . . .	14-1
DeviceNet Passthru . . . . .	14-2
Channel-to-channel Passthru . . . . .	14-2
Additional SLC 5/03 Passthru Status Bits . . . . .	14-4

Using RSLinx Classic, version 2.50 and higher, with SLC 5/03  
 Passthru ..... 14-5  
 SLC 5/03 Passthru Error Codes..... 14-7  
 Using RSLinx Classic, version 2.50 and higher, with SLC 5/04  
 Passthru ..... 14-8  
 Creating and Filling out the Passthru Routing Table File ..... 14-9  
 Using RSLinx Classic, version 2.50 and higher, with SLC 5/05  
 Passthru ..... 14-11  
 SLC 5/05 Passthru Error Codes..... 14-13  
 Optimizing RSLinx Channel 1 to DF1 Half-duplex Master/DF1  
 Radio Modem Passthru ..... 14-13

**Chapter 15**

**Messaging Examples**

Local versus Remote type Message ..... 15-1  
     Local Message ..... 15-1  
     Remote Message ..... 15-1  
 Remote Terminology ..... 15-2  
     Remote Bridge Address..... 15-2  
     Remote Station Address ..... 15-2  
     Remote Bridge Link ID..... 15-2  
 SLC 5/03 Passthru Examples ..... 15-3  
     Passthru Example: DF1 to DH-485 ..... 15-3  
     Passthru Example: DH-485 to DF1 ..... 15-6  
     Passthru Example: DH-485 to DH-485..... 15-9  
 SLC 5/04 Passthru Examples ..... 15-12  
     Passthru Example: DF1 to DH+ ..... 15-12  
     Passthru Example: DH+ to DF1 ..... 15-15  
     Passthru Example: DH-485 to DH+ ..... 15-16  
     Passthru Example: DH+ to DH-485 ..... 15-17  
 SLC 5/05 Passthru Examples ..... 15-18  
     Passthru Example: DF1 to Ethernet ..... 15-18  
     SLC 5/05 (IP Address 100.100.115.9) Bridge ..... 15-20  
     Passthru Routing Table ..... 15-21  
     Passthru Example: Ethernet to DF1 ..... 15-22  
     Passthru Example: DH-485 to Ethernet ..... 15-23  
     Passthru Example: Ethernet to DH-485 ..... 15-24  
 Remote Examples ..... 15-25  
     Remote Example: Network Overview ..... 15-25  
     Network Message Example: SLC 5/04 to SLC 5/02  
     via DHRIO and KA5 ..... 15-26  
     Network Message Example: SLC 5/04 to SLC 5/03  
     via DHRIO and KA5 ..... 15-27  
     Network Message Example: SLC 5/04 to SLC 5/04  
     via DHRIO ..... 15-28  
     Network Message Example: SLC 5/04 to SLC 5/02  
     via KA5 ..... 15-29



Network Message Example: SLC 5/04 to SLC 5/03 via KA5 .....	15-30
Network Message Example: SLC 5/04 to SLC 5/05 via DHRIO and ENET.....	15-31
Network Message Example: SLC 5/05 to SLC 5/04 via ENET and DHRIO.....	15-32
Network Message Example: SLC 5/05 to SLC 5/03 via ENET, CNB and KFC .....	15-33
Network Message Example: SLC 5/05 to SLC 5/03 via ENET, DHRIO and KA5.....	15-34
Network Message Example: PLC 5/20E to SLC 500 CH0 via ENI.....	15-35

## Chapter 16

### Troubleshooting Faults

Automatically Clear Faults.....	16-1
SLC Processors .....	16-1
Manually Clear Faults.....	16-2
Use the Fault Routine .....	16-2
SLC Processor Faults.....	16-3
Powerup Errors .....	16-3
Going-to-run Errors .....	16-4
Run Errors .....	16-6
User Program Instruction Errors .....	16-9
I/O Errors .....	16-11
Troubleshoot SLC 5/03 and Higher Processors .....	16-15
Powerup LED Display .....	16-15
Identify Processor Errors while Downloading an Operating System.....	16-15

## Appendix A

### SLC 5/03 (OS30x), SLC 5/04 (OS40x) and SLC 5/05 (OS50x) Firmware History

OS300, Series A, FRN 1 released: June 1993.....	A-1
Original Release .....	A-1
OS300, Series A, FRN 2 released: July 1993 .....	A-1
Enhancements .....	A-1
OS300, Series A, FRN 3 released: March 1994 .....	A-1
Enhancements .....	A-1
OS300, Series A, FRN 4 released: May 1994.....	A-1
Enhancements .....	A-1
OS301, Series A, FRN 5 released: August 1994.....	A-2
Enhancements .....	A-2

OS400, Series A, FRN 1	
released: August 1994.....	A-3
Original Release .....	A-3
OS301, Series A, FRN 6	
OS400, Series A, FRN 2	
released: November 1994.....	A-3
Enhancements .....	A-3
OS301, Series A, FRN 7	
OS400, Series A, FRN 3	
released: March 1995 .....	A-3
Enhancements .....	A-3
OS301, Series A, FRN 8	
OS400, Series A, FRN 4	
released: April 1995 .....	A-4
Enhancements .....	A-4
OS302, Series A, FRN 9	
OS401, Series A, FRN 5	
released: December 1995.....	A-4
Enhancements .....	A-4
OS401, Series A, FRN 6	
released: May 1996 .....	A-5
Enhancements .....	A-5
OS302, Series B, FRN 10	
OS401, Series B, FRN 7	
released: July 1997 .....	A-5
Enhancements .....	A-5
Special Note .....	A-5
OS500, Series A, FRN 1	
released: October 1997.....	A-6
Original Release .....	A-6
OS302, Series B, FRN 11	
OS401, Series B, FRN 8	
OS500, Series A, FRN 2	
released: November 1997.....	A-6
Enhancements .....	A-6
OS302, Series B, FRN 12	
released: November 1998	
OS401, Series B, FRN 9	
released: July, 1999	
OS501, Series A, FRN 3	
released: July 1998 .....	A-6
Enhancements (OS501 only).....	A-6

OS302, Series B, FRN 12	
released: November 1998	
OS401, Series B, FRN 9	
released: July 1999	
OS501, Series A, FRN 4	
released: February 1999 .....	A-6
Enhancements .....	A-6
OS302, Series B, FRN 14	
OS401, Series B, FRN 9	
released: July 1999	
OS501, Series A, FRN 4	
released: February, 1999.....	A-6
Enhancements .....	A-6
OS501, Series A, FRN 5	
released: April 1999 .....	A-7
Enhancements .....	A-7
OS302, Series C, FRN 3	
OS401, Series C, FRN 3	
OS501, Series C, FRN 3	
released: September 2000.....	A-7
Enhancements .....	A-7
OS302, Series C, FRN 4	
OS401, Series C, FRN 4	
OS501, Series C, FRN 4	
released: February 2001 .....	A-11
Enhancements .....	A-11
OS302, Series C, FRN 5	
OS401, Series C, FRN 5	
OS501, Series C, FRN 5	
released: October 2001.....	A-12
Enhancements .....	A-12
OS302, Series C, FRN 6	
OS401, Series C, FRN 6	
OS501, Series C, FRN 6	
released: November 2002.....	A-13
Enhancements .....	A-13
OS302, Series C, FRN 7	
OS401, Series C, FRN 7	
OS501, Series C, FRN 7	
released: November 2003.....	A-15
Enhancements .....	A-15

OS302, Series C, FRN 8  
 OS401, Series C, FRN 8  
 OS501, Series C, FRN 8  
 released: May 2004 . . . . . A-16  
     Enhancements . . . . . A-16  
 OS501, Series C, FRN 9  
 released: November 2004. . . . . A-16  
     Enhancements . . . . . A-16  
 OS302, Series C, FRN 10  
 OS401, Series C, FRN 10  
 OS501, Series C, FRN 10  
 released: January 2006 . . . . . A-19  
     Enhancements . . . . . A-19  
 OS302, Series C, FRN 11  
 OS401, Series C, FRN 11  
 OS501, Series C, FRN 11  
 released: June 2008. . . . . A-21  
     Enhancements . . . . . A-21

**Appendix B**

**SLC Status File**

Status File Overview . . . . . B-1  
 Status File Details . . . . . B-4  
     Conventions Used in the Displays . . . . . B-4

**Appendix C**

**Memory Usage**

Memory Usage Overview . . . . . C-1  
 Fixed and SLC 5/01 Processors . . . . . C-2  
     Estimating Total Memory Usage of Your System Using a  
     Fixed or SLC 5/01 Processor . . . . . C-4  
     Fixed Controller Memory Usage Example. . . . . C-5  
     SLC 5/01 Processor Memory Usage Example. . . . . C-6  
 SLC 5/02 Processor. . . . . C-7  
     Estimating Total Memory Usage of Your System Using a  
     SLC 5/02 Processor. . . . . C-10  
     SLC 5/02 Memory Usage Example . . . . . C-11  
 User Word Comparison Between SLC 5/03 (and higher)  
 Processors and the SLC 5/02 Processor. . . . . C-12  
     Instruction Words . . . . . C-12  
     Data Words . . . . . C-13  
 SLC 5/03, SLC 5/04, and SLC 5/05 Processor. . . . . C-13  
     Estimating Total Memory Usage of Your System Using an  
     SLC 5/03, SLC 5/04, or SLC 5/05 Processor. . . . . C-19  
     SLC 5/03, SLC 5/04, or SLC 5/05 Memory Usage Example. . C-20

<b>Programming Instruction References</b>	<b>Appendix D</b>	
	Valid Addressing Modes and File Types . . . . .	D-1
	Understanding the Different Addressing Modes . . . . .	D-2
<b>Data File Organization and Addressing</b>	<b>Appendix E</b>	
	Understanding File Organization . . . . .	E-1
	Processor File Overview . . . . .	E-1
	Addressing Data Files . . . . .	E-3
	Specifying Logical Addresses . . . . .	E-5
	Specifying Indexed Addresses . . . . .	E-10
	Monitoring Indexed Addresses . . . . .	E-13
	Specifying an Indirect Address . . . . .	E-14
	Addressing File Instructions - Using the File Indicator (#) . . .	E-15
	Numeric Constants . . . . .	E-18
	M0 and M1 Data Files - Specialty I/O Modules . . . . .	E-19
	Addressing M0-M1 Files . . . . .	E-20
	Restrictions on Using M0 and M1 Data File Addresses . . . . .	E-20
	Monitoring Bit Addresses . . . . .	E-20
	Transferring Data Between Processor Files and M0 or M1 Files . . . . .	E-21
	Access Time . . . . .	E-22
	Minimizing the Scan Time . . . . .	E-22
	Capturing M0-M1 File Data . . . . .	E-24
	Specialty I/O Modules with Retentive Memory . . . . .	E-24
	G Data Files - Specialty I/O Modules . . . . .	E-25
	Editing G File Data . . . . .	E-25
<b>Number Systems</b>	<b>Appendix F</b>	
	Binary Numbers . . . . .	F-1
	Positive Decimal Values . . . . .	F-1
	Negative Decimal Values . . . . .	F-2
	Hexadecimal Numbers . . . . .	F-3
	Hex Mask . . . . .	F-5
	Binary Floating-point Arithmetic . . . . .	F-6
<b>Application Example Programs</b>	<b>Appendix G</b>	
	Paper Drilling Machine Application Example . . . . .	G-1
	Paper Drilling Machine Operation Overview . . . . .	G-3
	Drill Mechanism Operation . . . . .	G-5
	Conveyor Operation . . . . .	G-6
	Drill Calculation and Warning . . . . .	G-10
	Time Driven Sequencer Application Example . . . . .	G-14
	Time Driven Sequencer Ladder Program . . . . .	G-14
	Event Driven Sequencer Application Example . . . . .	G-15
	Event Driven Sequencer Ladder Program . . . . .	G-15

On/Off Circuit Application Example. . . . . G-16  
On/Off Circuit Ladder Program. . . . . G-17  
Interfacing with Enhanced Bar Code Decoders Over DH-485  
Network Using the MSG Instruction . . . . . G-17  
    Processor and Decoder Operation . . . . . G-17  
    System Set Up . . . . . G-18  
    Operating Sequence. . . . . G-19  
    Sequence of Events . . . . . G-20  
    Optimizing MSG Time-out. . . . . G-21  
    Example MSG Instruction Configuration . . . . . G-21  
    Example Scanner and Decoder Configuration. . . . . G-22  
    Example Ladder Program . . . . . G-23

**Appendix H**

**Supported Read/Write Commands  
Index**

Supported Read/Write Commands. . . . . H-1  
    SLC 500 Alphabetical List of Instructions . . . . . 1-11  
Rockwell Automation Support . . . . . 1-12  
    Installation Assistance . . . . . 1-12  
    New Product Satisfaction Return . . . . . 1-12

Read this preface to familiarize yourself with the rest of the manual. It provides information concerning:

- who should use this manual.
- the purpose of this manual.
- related documentation.
- common techniques used in this manual

### **Who Should Use This Manual**

Use this manual if you are responsible for designing, installing, programming, or troubleshooting control systems that use SLC 500 programmable controllers.

You should have a basic understanding of electrical circuitry and familiarity with relay logic. If you do not, obtain the proper training before using this product.

### **Purpose of This Manual**

This manual is a reference guide for SLC 500 controllers. This manual:

- provides status file functions.
- provides the instructions used in your ladder logic programs.
- compliments the online help available at the terminal.

## Related Documentation

The following documents contain additional information concerning Rockwell Automation products. To obtain a copy, contact your local Rockwell Automation office or distributor.

For	Read This Document	Document Number
An overview of the SLC 500 family of products.	SLC 500 System Overview	1747-S0001
A description on how to install and use your Modular SLC 500 programmable controller.	Installation & Operation Manual for Modular Hardware Style Programmable Controllers	1747-UM011
A description on how to install and use your Fixed SLC 500 programmable controller.	Installation & Operation Manual for Fixed Hardware Style Programmable Controllers	1747-6.21
In-depth information on grounding and wiring Allen-Bradley programmable controllers.	Allen-Bradley Programmable Controller Grounding and Wiring Guidelines	1770-4.1
A description of important differences between solid-state programmable controller products and hard-wired electromechanical devices.	Application Considerations for Solid-State Controls	SGI-1.1
An article on wire sizes and types for grounding electrical equipment.	National Electrical Code - Published by the National Fire Protection Association of Boston, MA.	
A glossary of industrial automation terms and abbreviations.	Allen-Bradley Industrial Automation Glossary	AG-7.1

If you would like a manual, you can:

- download a free electronic version from the Internet at [www.literature.rockwellautomation.com](http://www.literature.rockwellautomation.com)
- purchase a printed manual by contacting your local distributor or Rockwell Automation representative

## Common Techniques Used in This Manual

The following conventions are used throughout this manual.

- Bulleted lists such as this one provide information, not procedural steps
- Numbered lists provide sequential steps or hierarchical information
- *Italic* type is used for emphasis



## Processor Files

### File Structure

SLC 500 user memory is comprised of Data Files and Program Files.

**TIP**

The file types shown below for data files 3 through 8 are the default values. Files 9 to 255 can be configured to be bit, timer, counter, control, integer, floating point, ASCII, or String files.

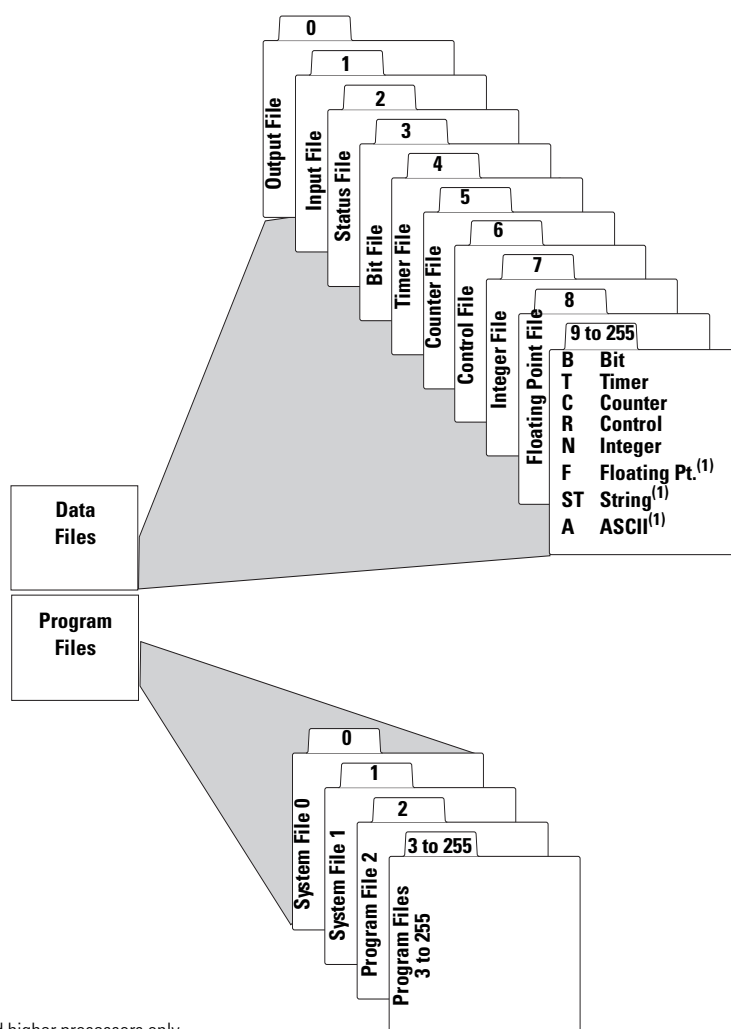

## Output and Input Data Files (Files 00: and I1:)

Data Files 0 and 1 represent external outputs and inputs, respectively. Bits in file 1 are used to represent external inputs. In most cases, a single 16-bit word in these files will correspond to a slot location in your controller, with bit numbers corresponding to input or output terminal numbers. Unused bits of the word are not available for use.

Table 1.1 explains the addressing format for outputs and inputs. Note that the format specifies **e** as the slot number and **s** as the word number. When referencing output and input data file words, refer to the element as **e.s** (slot and word), taken together.

**Table 1.1 Output and Input Data File Addressing Formats**

Format	Explanation		
<b>0:e.s/b</b>	<b>0</b>	Output	
	<b>I</b>	Input	
<b>I:e.s/b</b>	:	Element delimiter	
	<b>e</b>	Slot number (decimal)	Slot 0, adjacent to the power supply in the first chassis, applies to the processor module (CPU). Succeeding slots are I/O slots, numbered from 1 to a maximum of 30.
	.	Word delimiter.	Required only if a word number is necessary as noted below.
	<b>s</b>	Word number	Required if the number of inputs or outputs exceeds 16 for the slot. Range: 0-255 (range accommodates multi-word "specialty cards")
	/	Bit delimiter	
	<b>b</b>	Terminal number	Inputs: 0-15 Outputs: 0-15

**Examples:**

<b>0:3/15</b>	Output 15, slot3
<b>0:5/0</b>	Output 0, slot 5
<b>0:10/11</b>	Output 11, slot 10
<b>I:7/8</b>	Input 8, slot 7
<b>I:2.1/3</b>	Input 3, slot 2, word 1
<b>0:5</b>	Output word 0, slot 5
<b>0:5.1</b>	Output word 1, slot 5
<b>I:8</b>	Input word 0, slot 8

Default Values: Your programming device will display an address more formally. For example, when you assign the address 0:5/0, the programming device will show it as 0:5.0/0 (Output file, slot 5, word 0, terminal 0).

## Status File (File S2:)

You cannot add to or delete from the status file. See Table 1.2 to understand how to address various bits and words within the status file. You can address various bits and words as follows.

**Table 1.2 Status File Addressing Format**

Format	Explanation		
<b>S:e/b</b>	<b>S</b>	Status file	
	:	Element delimiter	
	<b>e</b>	Element number	Ranges from 0 to 15 in a fixed or SLC 5/01 controller, 0 to 32 in an SLC 5/02, 0 to 82 in an SLC 5/03 and 0 to 82 in an SLC 5/05, 0 to 96 in an SLC 5/04 OS400, and 0 to 163 in an SLC 5/04 OS401 processors. These are 1-word elements. 16 bits per element.
	/	Bit delimiter	
	<b>b</b>	Bit number	Bit location within the element. Ranges from 0 to 15.
<b>Examples:</b>			
<b>S:1/15</b>	Element 1, bit 15. This is the "first pass" bit, which you can use to initialize instructions in your program.		
<b>S:3</b>	Element 3. The lower byte of this element is the current scan time. The upper byte is the watchdog scan time.		

## Bit Data File (B3:)

File 3 is the bit file, used primarily for bit (relay logic) instructions, shift registers, and sequencers. The maximum size of the file is 256 1-word elements, a total of 4096 bits. You can address bits by specifying the element number (0 to 255) and the bit number (0 to 15) within the element. You can also address bits by numbering them in sequence, 0 to 4095.

You can also address elements of this file. See Table 1.3 for a detailed format description. Note the two different possible formats that can be used.

**Table 1.3 Bit File Addressing Format**

<b>Format</b>	<b>Explanation</b>		
<b>Bf:e/b</b>	<b>B</b>	Bit type file	
	<b>f</b>	File number. Number 3 is the default file. A file number between 9-255 can be used if additional storage is required.	
	:	Element delimiter	
	<b>e</b>	Element number	Ranges from 0-255. These are 1-word elements. 16 bits per element.
	/	Bit delimiter	
	<b>b</b>	Bit number	Bit location within the element. Ranges from 0-15.
<b>Bf/b</b>	<b>B</b>	Same as above.	
	<b>f</b>	Same as above.	
	/	Same as above.	
	<b>b</b>	Bit number	Numerical position of the bit within the file. Ranges from 0-4095.
<b>Examples:</b>			
<b>B3:3/14</b>	Bit 14, element 3		
<b>B3:252/00</b>	Bit 0, element 252		
<b>B3:9</b>	Bit 62		
<b>B3/62</b>	Bit 62		
<b>B3/4032</b>	Bit 4032		

## Timer Data File (T4:)

### TIP

Timing could be inaccurate if Jump (JMP), Label (LBL), Jump to Subroutine (JSR), or Subroutine (SBR) instructions skip over the rung containing a timer instruction while the timer is timing. If the skip duration is less than 2.5 seconds, no time will be lost; if the skip duration exceeds 2.5 seconds, an undetectable timing error occurs. When using subroutines, a timer must be executed at least every 2.5 seconds to prevent a timing error.

Timer instructions use various control bits. These are 3-word elements, used with Bit, TON, TOF and RTO instructions. Word 0 is the status word, word 1 indicates the preset value, and word 2 indicates accumulator value. This is shown in Table 1.4.

**Table 1.4 Timer Control Fields**

15	14	13	12	11	10	9	8	7	6	5	4	3	2	1	0	Word
EN	TT	DN							Internal Use <sup>(1)</sup>							0
Preset Value (PRE)																1
Accumulator Value (ACC)																2

<sup>(1)</sup> Bits labeled "Internal Use" are not addressable.

**Table 1.5 Timer Elements**

Addressable Bits	Addressable Words
EN = Enable (Bit 15)	PRE = Preset Value
TT = Timer Timing (Bit 14)	ACC = Accumulated Value
DN = Done (Bit 13)	

## Addressing Structure

Address bits and words using the format T:f:e.s/b.

**Table 1.6 Timer Addressing Format**

Explanation		
<b>T</b>	Timer file	
<b>f</b>	File number. For SLC 500 processors the default is 4. A file number between 9 to 255 can be used for additional storage.	
<b>:</b>	Element delimiter	
<b>e</b>	Element number	These are 3-word elements. The range is 0 to 255.
<b>.</b>	Word Delimiter	Range 0 to 2
<b>s</b>	Word Number	
<b>/</b>	Bit delimiter	
<b>b</b>	Bit Number	Range 0 to 15
Examples		
<b>T4:0/15 or T4:0/EN</b>	Enable bit	
<b>T4:0/14 or T4:0/TT</b>	Timer timing bit	
<b>T4:0/13 or T4:0/DN</b>	Done bit	
<b>T4:0.1 or T4:0.PRE</b>	Preset value of the timer	
<b>T4:0.2 or T4:0.ACC</b>	Accumulated value of the timer	
<b>T4:0.1/0 or T4:0.PRE/0</b>	Bit 0 of the preset value	
<b>T4:0.2/0 or T4:0.ACC/0</b>	Bit 0 of the accumulated value	

## Counter Data File Elements (C5:)

Each Counter address is made of a 3-word data file element. Word 0 is the control word, containing the status bits of the instruction. Word 1 is the preset value. Word 2 is the accumulated value.

The control word for counter instructions includes five status bits, as indicated below.

**Table 1.7 Counter Control Fields**

15	14	13	12	11	10	09	08	07	06	05	04	03	02	01	00	Word
CU	CD	DN	OV	UN	UA <sup>(1)</sup>				Internal Use <sup>(2)</sup>							0
Preset Value (PRE)																1
Accumulator Value (ACC)																2

<sup>(1)</sup> Fixed SLC 500 only.

<sup>(2)</sup> Bits labeled "Internal Use" are not addressable.

**Table 1.8 Counter Elements**

Addressable Bits	Addressable Words
CU = Count up enable (Bit 15)	PRE = Preset
CD = Count down enable (Bit 14)	ACC = Accum
DN = Done bit (Bit 13)	
OV = Overflow bit (Bit 12)	
UN = Underflow bit (Bit 11)	
UA = Update Accumulator bit (Bit 10) (Fixed Controller Only)	

## Entering Parameters

There are several parameters associated with Counter instructions. The following parameters detail the operations of the counter.

### *Accumulator Value (ACC)*

This is the number of false-to-true transitions that have occurred since the counter was last reset.

### *Preset Value (PRE)*

Specifies the value which the counter must reach before the controller sets the done bit (DN). When the accumulator value becomes equal to or greater than the preset value, the done status bit is set. You can use the done bit (DN) to control an output device.

Preset and accumulated values for counters range from -32,768 to +32,767, and are stored as signed integers. Negative values are stored in two's complement form.

## Addressing Structure

Assign counter addresses using the format **Cf:e.s/b**.

**Table 1.9 Counter File Addressing Format**

Explanation		
<b>C</b>	Counter	
<b>f</b>	File number. For SLC 500 processors the default is 5. A file number between 9 to 255 can be used for additional storage.	
:	Element delimiter	
<b>e</b>	Element number	These are 3-word elements. The range is 0 to 255.
.	Word Delimiter	
<b>s</b>	Word Element	0 to 2
/	Bit delimiter	
<b>b</b>	Bit Number	0 to 15
Examples		
<b>C5:0/15 or C5:0/CU</b>	Count up enable bit	
<b>C5:0/14 or C5:0/CD</b>	Count down enable bit	
<b>C5:0/13 or C5:0/DN</b>	Done bit	
<b>C5:0/12 or C5:0/OV</b>	Overflow bit	

**Table 1.9 Counter File Addressing Format**

Explanation	
<b>C5:0/11 or C5:0/UN</b>	Underflow bit
<b>C5:0/10 or C5:0/UA</b>	Update accum. bit (use with HSC in fixed controller only)
<b>C5:0.1 or C5:0.PRE</b>	Preset value of the counter
<b>C5:0.2 or C5:0.ACC</b>	Accumulated value of the counter
<b>C5:0.1/0 or C5:0.PRE/0</b>	Bit 0 of the preset value
<b>C5:0.2/0 or C5:0.ACC/0</b>	Bit 0 of the accumulated value

### Control Data File (R6:)

These instructions use various control bits. These are 3-word elements, used with bit shift, FIFO, LIFO, sequencer instructions, and ASCII instructions ABL, ACB, AHL, ARD, ARL, AWA, and AWT. Word 0 is the status word, word 1 indicates the length of stored data, and word 2 indicates position. This is shown in Table 1.10.

In the control element, there are eight status bits and an error code byte. A fixed controller and an SLC 5/01 control element has six bits. Bits EU and EM are not used by the processor.

**Table 1.10 Three Word Element Structure**

15	14	13	12	11	10	09	08	07	06	05	04	03	02	01	00	Word
EN	EU <sup>(1)</sup>	DN	EM <sup>(1)</sup>	ER	UL	IN	FD	Error Code								0
Length of Bit Array or File (LEN)																1
Bit Pointer or Position (POS)																2

<sup>(1)</sup> Not used in Fixed or SLC 5/01.

**Table 1.11 Control Elements**

Addressable Bits	Addressable Words
EN = Enable	LEN = Length
EU = Update Enable	POS = Position



**Table 1.11 Control Elements**

DN = Done	
EM = Stack Empty	
ER = Error	
UL = Unload	
IN = Inhibit	
FD = Found	

Assign control addresses as follows.

**Table 1.12 Control File Addressing Format**

Format	Explanation		
<b>Rf:e</b>	<b>R</b>	Control file	
	<b>f</b>	File number. Number 6 is the default file. A file number between 9 and 255 can be used if additional storage is required.	
	:	Element delimiter	
	<b>e</b>	Element number	Ranges from 0 to 255. These are 3-word elements. See figure above.
<b>Rf:e.s/b</b>	<b>Rf:e</b>	Explained above.	
	.	Word delimiter	
	<b>s</b>	Indicates word	
	/	Bit delimiter	
	<b>b</b>	Bit	

**Examples:**

<b>R6:2</b>	Element 2, control file 6 Address bits and words by using the format Rf:e.s/b
<b>R6:2/15 or R6:2/EN</b> <b>R6:2/14 or R6:2/EU</b> <b>R6:2/13 or R6:2/DN</b> <b>R6:2/12 or R6:2/EM</b> <b>R6:2/11 or R6:2/ER</b> <b>R6:2/10 or R6:2/UL</b> <b>R6:2/9 or R6:2/IN</b> <b>R6:2/8 or R6:2/FD</b>	Enable bit Unload Enable bit Done bit Stack Empty bit Error bit Unload bit Inhibit bit Found bit
<b>R6:2.1 or R6:2.LEN</b> <b>R6:2.2 or R6:2.POS</b>	Length value Position value
<b>R6:2.1/0</b> <b>R6:2.2/0</b>	<b>Bit 0 of length value</b> <b>Bit 0 of position value</b>

## Integer Data File (N7:)

Use these addresses as your program requires. These are 1-word elements, addressable at the element and bit level.

Assign integer addresses as follows.

**Table 1.13 Integer File Addressing Format**

Format	Explanation		
<b>Nf:e/b</b>	<b>N</b>	Integer file	
	<b>f</b>	File number. Number 7 is the default file. A file number between 9 to 255 can be used if additional storage is required.	
	<b>:</b>	Element delimiter	
	<b>e</b>	Element number	Ranges from 0 to 255. These are 1-word elements. 16 bits per element.
	<b>/</b>	Bit delimiter	
	<b>b</b>	Bit number	Bit location within the element. Ranges from 0 to 15.
<b>Examples:</b>			
<b>N7:2</b>	Element 2, integer file 7		
<b>N7:2/8</b>	Bit 8 in element 2, integer file 7		
<b>N10:36</b>	Element 36, integer file 10 (file 10 designated as an integer file by the user)		

## Float Data File (F8:)

Use these addresses as your program requires. These are 2-word elements, addressable at the element and bit level.

Assign float addresses as follows.

**Table 1.14 Float File Addressing Format**

Format	Explanation	
<b>Ff:e</b>	<b>F</b>	Integer file
	<b>f</b>	File number. Number 8 is the default file. A file number between 9 to 255 can be used if additional storage is required.
	<b>:</b>	Element delimiter
	<b>e</b>	Element number
<b>Examples:</b>		
<b>F8:2</b>	Element 2, float file 8	

**TIP**

Float data type cannot be accessed at the bit level.

**Notes:**

## Basic Instructions

This chapter contains general information about the basic instructions and explains how they function in your application program. Each of the basic instructions includes information on:

- the instruction symbol.
- the instruction format.
- the instruction usage.

The Basic Instructions detailed in this chapter are listed in Table 2.1.

**Table 2.1 Basic Instructions**

<b>Instruction Mnemonic</b>	<b>Instruction Name</b>	<b>Purpose</b>	<b>Page</b>
<b>XIC</b>	Examine if Closed	Examines a bit for an On condition.	2-3
<b>XIO</b>	Examine if Open	Examines a bit for an Off condition.	2-3
<b>OTE</b>	Output Energize	Turns a bit On or Off.	2-4
<b>OTL and OTU</b>	Output Latch and Output Unlatch	OTL turns a bit on when the rung is executed, and this bit retains its state when the rung is not executed or a power cycle occurs. OTU turns a bit off when the rung is executed, and this bit retains its state when the rung is not executed or when power cycle occurs.	2-4
<b>OSR</b>	One-shot Rising	Triggers a one-time event.	2-5
<b>TON</b>	Timer On-delay	Counts timebase intervals when the instruction is true.	2-9
<b>TOF</b>	Timer Off-delay	Counts timebase intervals when the instruction is false.	2-10
<b>RTO</b>	Retentive Timer	Counts timebase intervals when the instruction is true and retains the accumulated value when the instruction goes false or when power cycle occurs.	2-11
<b>CTU</b>	Count Up	Increments the accumulated value at each false-to-true transition and retains the accumulated value when the instruction goes false or when power cycle occurs.	2-13
<b>CTD</b>	Count Down	Decrements the accumulated value at each false-to-true transition and retains the accumulated value when the instruction goes false or when power cycle occurs.	2-14
<b>HSC</b>	High-speed Counter	Counts high-speed pulses from a fixed controller high-speed input.	2-15
<b>RES</b>	Reset	Resets the accumulated value and status bits of a timer or counter. Do not use with TOF timers.	2-20

## About the Basic Instructions

Basic instructions, when used in ladder programs, represent hardwired logic circuits used for the control of a machine or equipment.

The basic instructions are separated into three groups: bit, timer, and counter. Before you learn about the instructions in each of these groups, we suggest that you read the overviews that follow:

- Bit Instructions Overview.
- Timer Instructions Overview.
- Counter Instructions Overview.

## Bit Instructions Overview

Bit instructions operate on a single bit of data. During operation, the processor may set or reset the bit, based on logical continuity of ladder rungs. You can address a bit as many times as your program requires.

**TIP**

Using the same address with multiple output instructions is not recommended.

Bit instructions are used with the following data files.

- Output/Input Files
- Status File
- Bit File
- Timer File

## Examine if Closed (XIC)

Use the XIC instruction in your ladder program to determine if a bit is On. When the instruction is executed, if the bit addressed is on (1), then the instruction is evaluated as true. When the instruction is executed, if the bit addressed is off (0), then the instruction is evaluated as false.

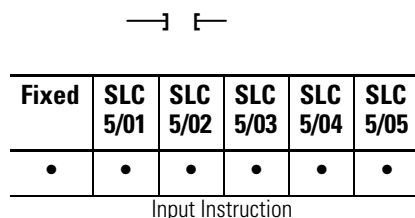

**Table 2.2 XIC Bit State**

Bit Address State	XIC Instruction
0	False
1	True

Examples of devices that turn on or off include:

- a push button wired to an input (addressed as I:0/4).
- an output wired to a pilot light (addressed as O:0/2).
- a timer controlling a light (addressed as T4:3/DN).

## Examine if Open (XIO)

Use the XIO instruction in your ladder program to determine if a bit is Off. When the instruction is executed, if the bit addressed is off (0), then the instruction is evaluated as true. When the instruction is executed, if the bit addressed is on (1), then the instruction is evaluated as false.

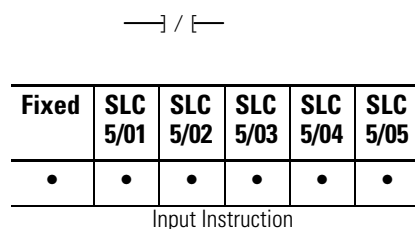

**Table 2.3 XIO Bit State**

Bit Address State	XIO Instruction
0	True
1	False

Examples of devices that turn on or off include:

- motor overload normally closed (N.C.) wired to an input (I:0/10).
- an output wired to a pilot light (addressed as O:0/4).
- a timer controlling a light (addressed as T4:3/DN).

## Output Energize (OTE)

—( )—

Fixed	SLC 5/01	SLC 5/02	SLC 5/03	SLC 5/04	SLC 5/05
•	•	•	•	•	•

Output Instruction

Use the OTE instruction in your ladder program to turn on a bit when rung conditions are evaluated as true.

An example of a device that turns on or off is an output wired to a pilot light (addressed as O:0/4).

OTE instructions are reset when:

- the SLC enters or returns to the REM Run or REM Test mode or power is restored.
- the OTE is programmed within an inactive or false Master Control Reset (MCR) zone.

**TIP**

A bit that is set within a subroutine using an OTE instruction remains set until the subroutine is scanned again.

## Output Latch (OTL) and Output Unlatch (OTU)

—(L)—

—(U)—

Fixed	SLC 5/01	SLC 5/02	SLC 5/03	SLC 5/04	SLC 5/05
•	•	•	•	•	•

Output Instructions

OTL and OTU are retentive output instructions. OTL can only turn on a bit, while OTU can only turn off a bit. These instructions are usually used in pairs, with both instructions addressing the same bit.

Your program can examine a bit controlled by OTL and OTU instructions as often as necessary.

**ATTENTION**



Under fatal error conditions, physical outputs are turned off. Once the error conditions are cleared, the controller resumes operation using the data table value of the operand.

### Using OTL

When you assign an address to the OTL instruction that corresponds to the address of a physical output, the output device wired to this screw terminal is energized when the bit is set (turned on or enabled).

When rung conditions become false (after being true), the bit remains set and the corresponding output device remains energized.



When enabled, the latch instruction tells the controller to turn on the addressed bit. Thereafter, the bit remains on, regardless of the rung condition, until the bit is turned off (typically by a OTU instruction in another rung).

## Using OTU

When you assign an address to the OTU instruction that corresponds to the address of a physical output, the output device wired to this screw terminal is de-energized when the bit is cleared (turned off or disabled).

The unlatch instruction tells the controller to turn off the addressed bit. Thereafter, the bit remains off, regardless of the rung condition, until it is turned on (typically by a OTL instruction in another rung).

## One-shot Rising (OSR)

—[OSR]—

Fixed	SLC 5/01	SLC 5/02	SLC 5/03	SLC 5/04	SLC 5/05
•	•	•	•	•	•

Input Instruction

The OSR instruction is a retentive input instruction that triggers an event to occur one time. Use the OSR instruction when an event must start based on the change of state of the rung from false-to-true.

When the rung conditions preceding the OSR instruction go from false-to-true, the OSR instruction will be true for one scan. After one scan is complete, the OSR instruction becomes false, even if the rung conditions preceding it remain true. The OSR instruction will only become true again if the rung conditions preceding it transition from false-to-true.

The SLC 500 and SLC 5/01 processors allow you to use one OSR instruction per output in a rung; the OSR cannot be within a branch. The SLC 5/02 and higher processors allow you to use one OSR instruction per output in a rung; putting the OSR within a branch is permitted.

## Entering Parameters

The address assigned to the OSR instruction is *not* the one-shot address referenced by your program, nor does it indicate the state of the OSR instruction. This address allows the OSR instruction to remember its previous rung state.

Use a bit address from either the bit or integer data file. The addressed bit is set (1) for one scan when rung conditions preceding the OSR instruction are true (even if the OSR instruction becomes false); the bit is reset (0) when rung conditions preceding the OSR instruction are false.

**TIP**

The bit address you use for this instruction must be unique. Do not use it elsewhere in the program.

Do not use an input or output address to program the address parameter of the OSR instruction.

*Examples*

The following rungs illustrate the use of the OSR instruction. The first four rungs apply to SLC 500 and SLC 5/01 processors. The fifth rung involves output branching and applies to the SLC 5/02 and higher processors.

SLC 500 and SLC 5/01 Processors

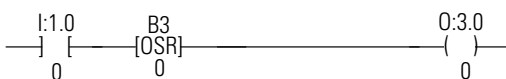

When the input instruction goes from false-to-true, the OSR instruction conditions the rung so that the output goes true for one program scan. The output goes false and remains false for successive scans until the input makes another false-to-true transition.

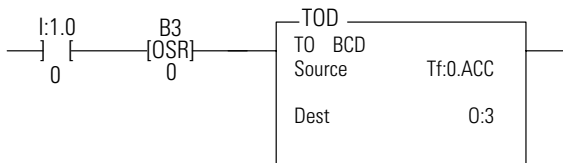

In this case, the accumulated value of a timer is converted to BCD and moved to an output word where an LED display is connected. When the timer is running, the accumulated value is changing rapidly. This value can be frozen and displayed for each false-to-true transition of the input condition of the rung.

Using an OSR Instruction in a Branch (SLC 500 and SLC 5/01 Processors)

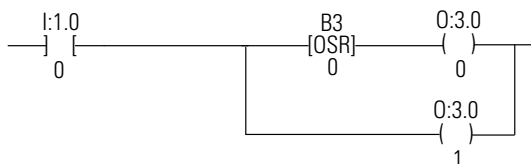

In the above rung, the OSR instruction is not permitted inside a branch.

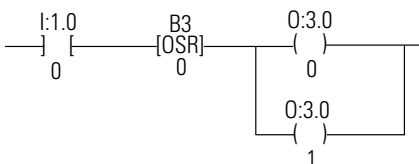

In this case, the OSR instruction is not in the branch so the rung is legal.

The SLC 500 and SLC 5/01 processors allow you to use only one OSR instruction per rung.

### ATTENTION



When using a SLC 500 or SLC 5/01 processor, do not place input conditions after the OSR instruction in a rung. Unexpected operation may occur.

SLC 5/02 (and higher) Processors

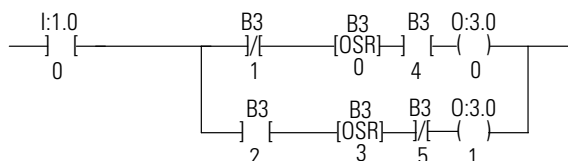

The SLC 5/02 and higher processors allow you to use one OSR instruction per output in a rung. They also allow input conditions after the OSR instruction. Input branching around an OSR instruction is not allowed.

## Timer Instructions Overview

### Entering Parameters

These are several parameters associated with Timer instructions. The following paragraphs detail the operation of the timer instruction.

#### *Accumulator Value (.ACC)*

This is the time elapsed since the timer was last reset. When enabled, the timer updates this continually.

#### *Preset Value (.PRE)*

This specifies the value which the timer must reach before the controller sets the done bit. When the accumulated value becomes equal to or greater than the preset value, the done (DN) bit is set. You can use this bit to control an output device.

Preset and accumulated values for timers range from 0 to +32,767. If a timer preset or accumulated value is a negative number, a runtime error occurs.

### *Timebase*

The timebase determines the duration of each timebase interval. For Fixed and SLC 5/01 processors, the timebase is set at 0.01 second.

---

**EXAMPLE**

If the timer base is set to 0.01, it would take 100 counts as the preset value (PRE) to equal 1 seconds worth of timing.

---

### *Timer Accuracy*

Timer accuracy refers to the length of time between the moment a timer instruction is enabled and the moment the timed interval is complete. Inaccuracy caused by the program scan can be greater than the timer timebase. You must also consider the time required to energize the output device.

Timing accuracy is -0.01 to 0 seconds, with a program scan of up to 2.5 seconds. The 1-second timer maintains accuracy with a program scan of up to 1.5 seconds. If your programs can exceed 1.5 or 2.5 seconds, repeat the timer instruction rung so that the rung is scanned within these limits.

## Timer On-delay (TON)

Use the TON instruction to turn an output on or off after the timer has been on for a preset time interval. The TON instruction begins to count timebase intervals when rung conditions become true. As long as rung conditions remain true, the timer adjusts its accumulated value (ACC) each evaluation until it reaches the preset value (PRE). The accumulated value is reset when rung conditions go false, regardless of whether the timer has timed out.

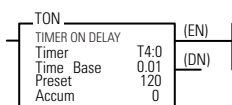

Fixed	SLC 5/01	SLC 5/02	SLC 5/03	SLC 5/04	SLC 5/05
•	•	•	•	•	•

Output Instruction

### Using Status Bits

**Table 2.4 Setting TON Status Bits**

This Bit	Is Set When	And Remains Set Until One of the Following
Timer Done Bit DN (bit 13)	accumulated value is equal to or greater than the preset value	rung conditions go false
Timer Timing Bit TT (bit 14)	rung conditions are true and the accumulated value is less than the preset value	rung conditions go false or when the done bit is set
Timer Enable Bit EN (bit 15)	rung conditions are true	rung conditions go false

When the processor changes from the REM Run or REM Test mode to the REM Program mode or user power is lost while the instruction is timing but has not reached its preset value, the following occur.

- Timer Enable (EN) bit remains set
- Timer Timing (TT) bit remains set
- Accumulated value (ACC) remains the same

On returning to the REM Run or REM Test mode, the following can happen.

**Table 2.5 Returning to REM Run or REM Test Mode**

Condition	Result
If the rung is true:	EN bit remains set. TT bit remains set. ACC value is reset.
If the rung is false:	EN bit is reset. TT bit is reset. ACC value is reset.

## Timer Off-delay (TOF)

Use the TOF instruction to turn an output on or off after its rung has been off for a preset time interval. The TOF instruction begins to count timebase intervals when the rung makes a true-to-false transition. As long as rung conditions remain false, the timer increments its accumulated value (ACC) based on the timebase for each scan until it reaches the preset value (PRE). The accumulated value is reset when rung conditions go true regardless of whether the timer has timed out.

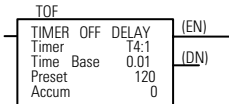

Fixed	SLC 5/01	SLC 5/02	SLC 5/03	SLC 5/04	SLC 5/05
•	•	•	•	•	•

Output Instruction

### Using Status Bits

**Table 2.6 Setting TOF Status Bits**

This Bit	Is Set When	And Remains Set Until One of the Following
Timer Done Bit DN (Bit 13)	rung conditions are true	rung conditions go false and the accumulated value is greater than or equal to the preset value
Timer Timing Bit TT (Bit 14)	rung conditions are false and the accumulated value is less than the preset value	rung conditions go true or when the done bit is reset
Timer Enable Bit EN (Bit 15)	rung conditions are true	rung conditions go false

When processor operation changes from the REM Run or REM Test mode to the REM Program mode or user power is lost while a timer off-delay instruction is timing but has not reached its preset value, the following occurs.

- Timer Enable (EN) bit remains set
- Timer Timing (TT) bit remains set
- Timer Done (DN) bit remains set
- Accumulated value (ACC) remains the same

On returning to the REM Run or REM Test mode, the following can happen.

**Table 2.7 Returning to REM Run or REM Test Mode**

Condition	Result
If the rung is true:	TT bit is reset DN bit remains set EN bit is set ACC value is reset.
If the rung is false:	TT bit is reset DN bit is reset EN bit is reset ACC value is set equal to the preset value.

**ATTENTION**



The Reset (RES) instruction cannot be used with the TOF instruction because RES always clears the status bits as well as the accumulated value. (See 2-20)

**TIP**

The TOF timer times inside an inactive MCR Pair.

## Retentive Timer (RTO)

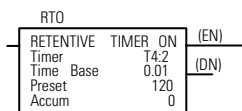

Fixed	SLC 5/01	SLC 5/02	SLC 5/03	SLC 5/04	SLC 5/05
•	•	•	•	•	•

Output Instruction

Use the RTO instruction to turn an output on or off after its timer has been on for a preset time interval. The RTO instruction is a retentive instruction that begins to count timebase intervals when rung conditions become true.

The RTO instruction retains its accumulated value when any of the following occurs.

- Rung conditions become fals.
- You change processor operation from the REM Run or REM Test mode to the REM Program mode
- The processor loses power (provided that battery backup is maintained)
- A fault occurs

When you return the processor to the REM Run or REM Test mode and/or rung conditions go true, timing continues from the retained accumulated value. By retaining its accumulated value, retentive timers measure the cumulative period during which rung conditions are true.

## Using Status Bits

**Table 2.8 Setting RTO Status Bits**

This Bit	Is Set When	And Remains Set Until One of the Following
Timer Done Bit DN (Bit 13)	accumulated value is equal to or greater than the preset value	the appropriate RES instruction is enabled
Timer Timing Bit TT (Bit 14)	rung conditions are true and the accumulated value is less than the preset value	Rung conditions go false or when the done bit is set
Timer Enable Bit EN (Bit 15)	rung conditions are true	rung conditions go false or if the timer is reset with the RES instruction

### TIP

To reset the retentive timer's accumulated value and status bits after the RTO rung goes false, you must program a reset (RES) instruction with the same address in another rung.

When the processor changes from the REM Run or REM Test mode to the REM Program or REM Fault mode, or user power is lost while the timer is timing but not yet at the preset value, the following occurs.

- Timer Enable (EN) bit remains set
- Timer Timing (TT) bit remains set
- Accumulated value (ACC) remains the same

On returning to the REM Run or REM Test mode or when power is restored, the following can happen.

**Table 2.9 Returning to REM Run or REM Test Mode**

Condition	Results
If the rung is true:	TT bit remains set. EN bit remains set. ACC value remains the same and resumes incrementing.
If the rung is false:	TT bit is reset. DN bit remains in its last state. EN bit is reset. ACC value remains in its last state.



## Counter Instructions Overview

### How Counters Work

The figure below demonstrates how a counter works. The count value must remain in the range of  $-32768$  to  $+32767$ . If the count value goes above  $+32767$  or below  $-32768$ , the counter status overflow (OV) or underflow (UN) bit is set.

A counter can be reset to zero using the reset (RES) instruction.

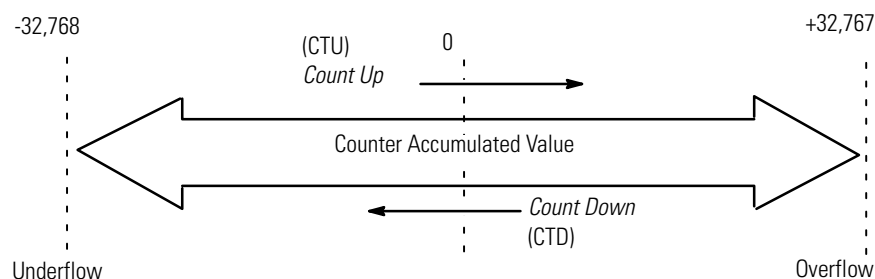

### Count Up (CTU)

The CTU is an instruction that counts false-to-true rung transitions. Rung transitions can be caused by events occurring in the program (from internal logic or by external field devices) such as parts traveling past a detector or actuating a limit switch.

When rung conditions for a CTU instruction have made a false-to-true transition, the accumulated value is incremented by one count, provided that the rung containing the CTU instruction is evaluated between these transitions. The ability of the counter to detect false-to-true transitions depends on the speed (frequency) of the incoming signal.

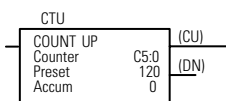

Fixed	SLC 5/01	SLC 5/02	SLC 5/03	SLC 5/04	SLC 5/05
•	•	•	•	•	•

Output Instruction

**TIP** The on and off duration of an incoming signal must not be faster than the scan time x2 (assuming a 50% duty cycle).

The accumulated value is retained when the rung conditions again become false. The accumulated count is retained until cleared by a reset (RES) instruction that has the same address as the counter reset.

## Using Status Bits

**Table 2.10 Setting CTU Status Bits**

This Bit	Is Set When	And Remains Set Until One of the Following
Count Up Overflow Bit OV (Bit 12)	accumulated value wraps around to -32,768 (from +32,767) and continues counting up from there	a RES instruction having the same address as the CTU instruction is executed OR the count is decremented less than or equal to +32,767 with a CTD instruction
Done Bit DN (Bit 13)	accumulated value is equal to or greater than the preset value	the accumulated value becomes less than the preset value
Count Up Enable Bit CU (Bit 15)	rung conditions are true	rung conditions go false OR a RES instruction having the same address as the CTU instruction is enabled

The accumulated value is retained after the CTU instruction goes false, or when power is removed from and then restored to the controller. Also, the on or off status of counter done, overflow, and underflow bits is retentive. The accumulated value and control bits are reset when the appropriate RES instruction is enabled. The CU bits are always set prior to entering the REM Run or REM Test modes.

## Count Down (CTD)

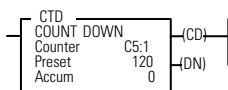

The CTD is an instruction that counts false-to-true rung transitions. Rung transitions can be caused by events occurring in the program such as parts traveling past a detector or actuating a limit switch.

When rung conditions for a CTD instruction have made a false-to-true transition, the accumulated value is decremented by one count, provided that the rung containing the CTD instruction is evaluated between these transitions.

Fixed	SLC 5/01	SLC 5/02	SLC 5/03	SLC 5/04	SLC 5/05
•	•	•	•	•	•

Output Instruction

The accumulated counts are retained when the rung conditions again become false. The accumulated count is retained until cleared by a reset (RES) instruction that has the same address as the counter reset.

## Using Status Bits

**Table 2.11 Setting CTD Status Bits**

This Bit	Is Set When	And Remains Set Until One of the Following
Count Down Underflow Bit UN (Bit 11)	accumulated value wraps around to +32,767 (from -32,768) and continues counting down from there	a RES instruction having the same address as the CTD instruction is enabled. OR the count is incremented greater than or equal to +32,767 with a CTU instruction
Done Bit DN (Bit 13)	accumulated value is equal to or greater than the preset value	the accumulated value becomes less than the preset
Count Down Enable Bit CD (Bit 14)	rung conditions are true	rung conditions go false OR a RES instruction having the same address as the CTD instruction is enabled

The accumulated value is retained after the CTD instruction goes false, or when power is removed from and then restored to the controller. Also, the on or off status of counter done, overflow, and underflow bits is retentive. The accumulated value and control bits are reset when the appropriate RES instruction is executed. The CD bits are always set prior to entering the REM Run or REM Test modes.

## High-speed Counter (HSC)

The High-speed Counter is a variation of the CTU counter. The HSC instruction is enabled when the rung logic is true and disabled when the rung logic is false.

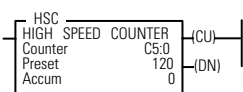

Fixed	SLC 5/01	SLC 5/02	SLC 5/03	SLC 5/04	SLC 5/05
•					

Output Instruction

**IMPORTANT** Do not place the XIC instruction with address I:0/0 in series with the HSC instruction because counts will be lost.

The HSC instruction counts transitions that occur at input terminal I:0/0. The HSC instruction does not count rung transitions. You enable or disable the HSC rung to enable or disable the counting of transitions occurring at input terminal I:0/0. We recommend placing the HSC instruction in an unconditional rung.

The HSC is a special CTU counter for use with 24 VDC SLC fixed controllers. The HSC's status bits and accumulated values are non-retentive.

This instruction provides high-speed counting for fixed I/O controllers with 24 VDC inputs. One HSC instruction is allowed per controller. To use the instruction, you must cut the jumper as shown below. A shielded cable is recommended to reduce noise to the input.

## High-speed Counter Data Elements

Address C5:0 is the HSC counter 3-word element.

**Table 2.12 High Speed Counter Structure**

15	14	13	12	11	10	09	08	07	06	05	04	03	02	01	00	Word
CU	CD	DN	OV	UN	UA				Not Used							0
Preset Value																1
Accumulator Value																2

CU	Count up enable (Bit 15)
CD	Count down enable (Bit 14)
DN	Done bit (Bit 13)
OV	Overflow bit (Bit 12)
UN	Underflow bit (Bit 11)
UA	Update accumulator (HSC only) (Bit 10)

- Word 0 contains the following status bits of the HSC instruction.
  - Bit 10 (UA) updates the accumulator word of the HSC to reflect the immediate state of the HSC when true.
  - Bit 12 (OV) indicates if a HSC overflow has occurred.
  - Bit 13 (DN) indicates if the HSC preset value has been reached.
  - Bit 15 (CU) shows the Enable/Disable state of the HSC instruction.
- Word 1 contains the preset value that is loaded into the HSC when either the RES instruction is executed, when the Done bit is set, or when powerup takes place. The valid range is +1 to +32767.
- Word 2 contains the HSC accumulator value. This word is updated each time the HSC instruction is evaluated and when the update accumulator bit is set using an OTE instruction. This accumulator is read only. Any value written to the accumulator is overwritten by the actual high-speed counter on instruction evaluation, reset, or REM Run mode entry.

## High-speed Counter Operation

For high-speed counter operation you must:

1. Turn off power to the fixed controller.
2. Remove the SLC 500 cover.
3. Locate and cut jumper wire J2. Do not remove completely but make certain that the ends of the cut jumper wire are not touching each other.

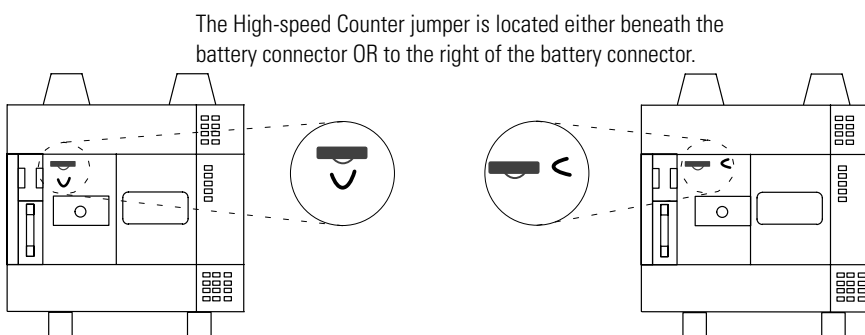

4. Replace the cover.

Input I:0/0 then operates in the high-speed mode. The address of the high-speed counter enable bit is C5:0/CU. When rung conditions are true, C5:0/CU is set and transitions occurring at input I:0/0 are counted.

To begin high-speed counting, load a preset value into C5:0.PRE and enable the counter rung. To load a preset value, do one of the following.

- Change to the REM Run or REM Test mode from another mode
- Power up the processor in the REM Run mode
- Reset the HSC using the RES instruction

Automatic reloading occurs when the HSC itself sets the DN bit on interrupt.

Each input transition that occurs at input I:0/0 causes the HSC accumulated value to increment. When the accumulated value equals the preset value, the Done bit (C5:0/DN) is set, the accumulated value is cleared, and the preset value (C5:0.PRE) is loaded into the HSC in preparation for the next high-speed transition at input I:0/0.

Your ladder program should poll the Done bit (C5:0/DN) to determine the state of the HSC. Once the Done bit has been detected as set, the ladder program should clear bit C5:0/DN (using the unlatch OTU instruction) before the HSC accumulated again reaches the preset value, or the overflow bit (C5:0/OV) will be set.

The HSC differs from the CTU and CTD counters. The CTU and CTD are software counters. The HSC is a hardware counter and operates asynchronously to the ladder program scan. The HSC accumulated value (C5:0.ACC) is normally updated each time the HSC rung is evaluated in the ladder program. This means that the HSC hardware accumulator value is transferred to the HSC software accumulator. Only use the OTE instruction to transfer this value. The HSC instruction immediately clears bit C5:0/UA following the accumulated update.

Many HSC counts may occur between HSC evaluations, which would make C5:0.ACC inaccurate when used throughout a ladder program. To allow for an accurate HSC accumulated value, the update accumulator bit (C5:0/UA) causes C5:0.ACC to be immediately updated to the state of the hardware accumulator when set.

Use the RES instruction to reset the high-speed counter at address C5:0. The HSC instruction clears the status bits, the accumulator, and loads the preset value during:

- power up.
- entry into the REM Run mode.
- a reset.

### *Application Example*

In the following figures, rungs 1, 18, and 31 of the main program file each consist of an XIC instruction addressed to the HSC done bit and a JSR instruction. These rungs poll the status of the HSC done bit. When the Done bit is set at any of these poll points, program execution moves to subroutine file 3, executing the HSC logic. After the HSC logic is executed, the Done bit is reset by an unlatch instruction, and program execution returns to the main program file.

*Application Example - File 2 (Poll for DN Bit in Main Program)*

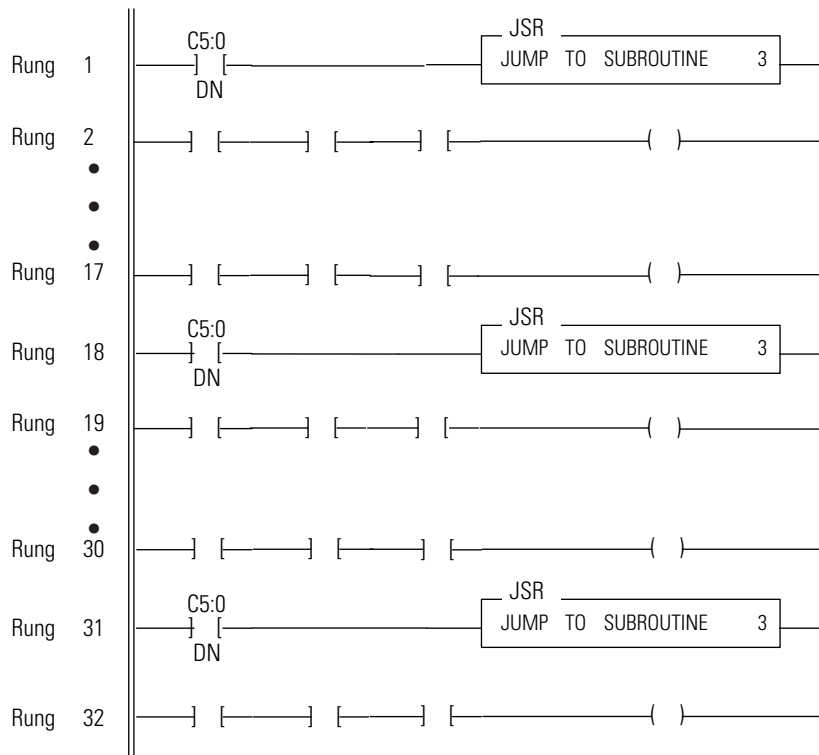

*Application Example - File 3 (Execute HSC Logic)*

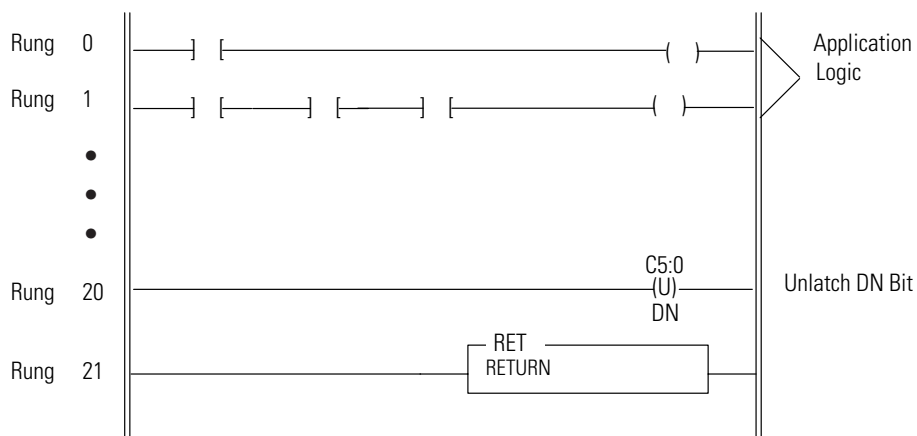

## Reset (RES)

Use a RES instruction to reset a timer or counter. When the RES instruction is enabled, it resets the Timer On Delay (TON), Retentive Timer (RTO), Count Up (CTU), or Count Down (CTD) instruction having the same address as the RES instruction.

—(RES)—

Fixed	SLC 5/01	SLC 5/02	SLC 5/03	SLC 5/04	SLC 5/05
•	•	•	•	•	•

Output Instruction

**Table 2.13 Using an RES Instruction**

Using a RES instruction for a:	The processor resets the:
Timer (Do not use a RES instruction with a TOF.)	ACC value to 0 DN bit TT bit EN bit
Counter	ACC value to 0 OV bit UN bit DN bit CU bit CD bit
Control	POS value to 0 EN bit EU bit DN bit EM bit ER bit UL bit IN and FD go to last state

When resetting a counter, if the RES instruction is enabled and the counter rung is enabled, the CU or CD bit is reset.

If the counter preset value is negative, the RES instruction sets the accumulated value to zero. This in turn causes the done bit to be set by a count down or count up instruction.

**ATTENTION**



Because the RES instruction resets the accumulated value, and the done, timing, and enabled bits, do not use the RES instruction to reset a timer address used in a TOF instruction. Otherwise, unpredictable machine operation or injury to personnel may occur.



## Comparison Instructions

This chapter contains general information about comparison instructions and explains how they function in your application program. Each of the comparison instructions includes information on:

- the instruction symbol.
- instruction usage.

**Table 3.1 Comparison Instructions**

<b>Instruction Mnemonic</b>	<b>Instruction Name</b>	<b>Purpose</b>	<b>Page</b>
<b>EQU</b>	Equal	Test whether two values are equal.	3-2
<b>NEQ</b>	Not Equal	Test whether one value is not equal to a second value.	3-2
<b>LES</b>	Less Than	Test whether one value is less than a second value.	3-3
<b>LEQ</b>	Less Than or Equal	Test whether one value is less than or equal to a second value.	3-3
<b>GRT</b>	Greater Than	Test whether one value is greater than another.	3-3
<b>GEO</b>	Greater Than or Equal	Test whether one value is greater than or equal to a second value.	3-4
<b>MEQ</b>	Masked Comparison for Equal	Test portions of two values to see whether they are equal. Compares 16-bit data of a source address to 16-bit data at a reference address through a mask.	3-4
<b>LIM</b>	Limit Test	Test whether one value is within the limit range of two other values.	3-5

### About the Comparison Instructions

Comparison instructions are used to test pairs of values to condition the logical continuity of a rung. As an example, suppose a LES instruction is presented with two values. If the first value is less than the second, then the comparison instruction is true.

To learn more about the compare instructions, we suggest that you read the Compare Instructions Overview that follows.

## Comparison Instructions Overview

The following general information applies to comparison instructions.

### Using Indexed Word Addresses

When using comparison instructions, you have the option of using indexed word addresses for instruction parameters specifying word addresses.

### Using Indirect Word Addresses

You have the option of using indirect word-level and bit-level addresses for instructions specifying word addresses when using an SLC 5/03 OS302, SLC 5/04 OS401, or SLC 5/05 processors.

### Equal (EQU)

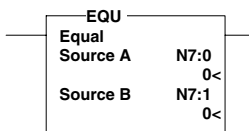

Fixed	SLC 5/01	SLC 5/02	SLC 5/03	SLC 5/04	SLC 5/05
•	•	•	•	•	•

Input Instruction

Use the EQU instruction to test whether two values are equal. If source A and source B are equal, the instruction is logically true. If these values are not equal, the instruction is logically false.

Source A must be an address. Source B can either be a program constant or a address. Negative integers are stored in two's complement form.

### Not Equal (NEQ)

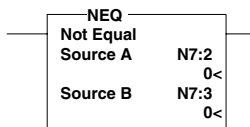

Fixed	SLC 5/01	SLC 5/02	SLC 5/03	SLC 5/04	SLC 5/05
•	•	•	•	•	•

Input Instruction

Use the NEQ instruction to test whether two values are not equal. If source A and source B are not equal, the instruction is logically true. If the two values are equal, the instruction is logically false.

Source A must be an address. Source B can be either a program constant or an address. Negative integers are stored in two's complement form.

## Less Than (LES)

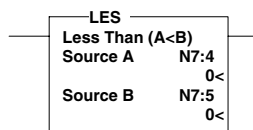

Fixed	SLC 5/01	SLC 5/02	SLC 5/03	SLC 5/04	SLC 5/05
•	•	•	•	•	•

Input Instruction

Use the LES instruction to test whether one value (source A) is less than another (source B). If source A is less than the value at source B, the instruction is logically true. If the value at source A is greater than or equal to the value at source B, the instruction is logically false.

Source A must be an address. Source B can either be a program constant or an address. Negative integers are stored in two's complement form.

## Less Than or Equal (LEQ)

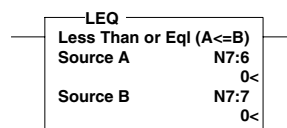

Fixed	SLC 5/01	SLC 5/02	SLC 5/03	SLC 5/04	SLC 5/05
•	•	•	•	•	•

Input Instruction

Use the LEQ instruction to test whether one value (source A) is less than or equal to another (source B). If the value at source A is less than or equal to the value at source B, the instruction is logically true. If the value at source A is greater than the value at source B, the instruction is logically false.

Source A must be an address. Source B can either be a program constant or an address. Negative integers are stored in two's complement form.

## Greater Than (GRT)

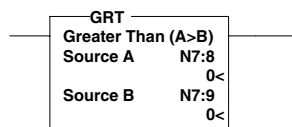

Fixed	SLC 5/01	SLC 5/02	SLC 5/03	SLC 5/04	SLC 5/05
•	•	•	•	•	•

Input Instruction

Use the GRT instruction to test whether one value (source A) is greater than another (source B). If the value at source A is greater than the value at source B, the instruction is logically true. If the value at source A is less than or equal to the value at source B, the instruction is logically false.

Source A must be an address. Source B can either be a program constant or an address. Negative integers are stored in two's complement form.

## Greater Than or Equal (GEQ)

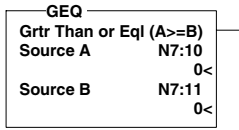

Fixed	SLC 5/01	SLC 5/02	SLC 5/03	SLC 5/04	SLC 5/05
•	•	•	•	•	•

Input Instruction

Use the GEQ instruction to test whether one value (source A) is greater than or equal to another (source B). If the value at source A is greater than or equal to the value at source B, the instruction is logically true. If the value at source A is less than the value at source B, the instruction is logically false.

Source A must be an address. Source B can either be a program constant or an address. Negative integers are stored in two's complement form.

## Masked Comparison for Equal (MEQ)

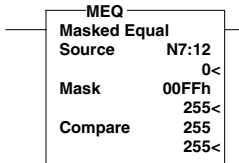

Fixed	SLC 5/01	SLC 5/02	SLC 5/03	SLC 5/04	SLC 5/05
•	•	•	•	•	•

Input Instruction

Use the MEQ instruction to compare data at a source address with data at a compare address. Use of this instruction allows portions of the data to be masked by a separate word.

### Entering Parameters

- Source is the address of the value you want to compare.
- Mask is the address of the mask through which the instruction moves data. The mask can also be a hexadecimal value (constant).
- Compare is an integer value or the address of the reference.

If the 16 bits of data at the source address are equal to the 16 bits of data at the compare address (less masked bits), the instruction is true. The instruction becomes false as soon as it detects a mismatch. Bits in the mask word mask data when reset; they pass data when set.

## Limit Test (LIM)

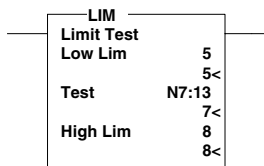

Fixed	SLC 5/01	SLC 5/02	SLC 5/03	SLC 5/04	SLC 5/05
		•	•	•	•

Input Instruction

Use the LIM instruction to test for values within or outside a specified range, depending on how you set the limits.

### Entering Parameters

The Low Limit, Test, and High Limit values can be word addresses or constants, restricted to the following combinations:

- If the Test parameter is a program constant, both the Low Limit and High Limit parameters must be word addresses.
- If the Test parameter is a word address, the Low Limit and High Limit parameters can be either a program constant or a word address.

### True/False Status of the Instruction

If the Low Limit has a value equal to or less than the High Limit, the instruction is true when the Test value is between the limits or is equal to either limit. If the Test value is outside the limits, the instruction is false, as shown below.

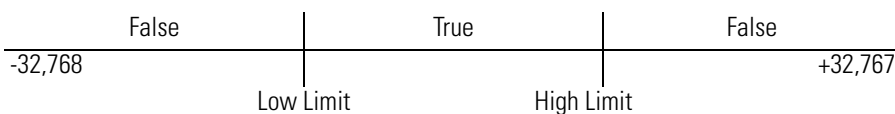

#### Example, low limit less than high limit:

Low Limit	High Limit	Instruction is True when Test value is	Instruction is False when Test value is
5	8	5 through 8	-32,768 through 4 and 9 through 32,767

If the Low Limit has a value greater than the High Limit, the instruction is false when the Test value is between the limits. If the Test value is equal to either limit or outside the limits, the instruction is true, as shown below.

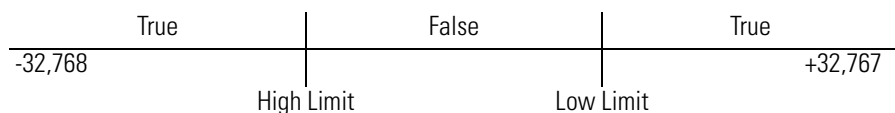

#### Example, low limit greater than high limit:

Low Limit	High Limit	Instruction is True when Test value is	Instruction is False when Test value is
8	5	-32,768 through 5 and 8 through 32,767	6 and 7

**Notes:**

## Math Instructions

This chapter contains general information about math instructions and explains how they function in your logic program. Each of the math instructions includes information on:

- instruction symbol.
- instruction usage.

**Table 4.1 Math Instructions**

Instruction		Purpose	Page
Mnemonic	Name		
<b>ADD</b>	Add	Adds source A to source B and stores the result in the destination.	4-5
<b>SUB</b>	Subtract	Subtracts source B from source A and stores the result in the destination.	4-5
<b>MUL</b>	Multiply	Multiplies source A by source B and stores the result in the destination.	4-8
<b>DIV</b>	Divide	Divides source A by source B and stores the result in the destination and the math register.	4-9
<b>DDV</b>	Double Divide	Divides the contents of the math register by the source and stores the result in the destination and the math register.	4-11
<b>CLR</b>	Clear	Sets all bits of a word to zero.	4-12
<b>SQR</b>	Square Root	Calculates the square root of the source and places the integer result in the destination.	4-12
<b>SCP</b>	Scale with Parameters	Produces a scaled output value that has a linear relationship between the input and scaled values.	4-13
<b>SCL</b>	Scale Data	Multiplies the source by a specified rate, adds to an offset value, and stores the result in the destination.	4-15
<b>RMP</b>	Ramp	Provides the ability to create linear, acceleration, deceleration, and “S” curve ramp output data wave forms.	4-20
<b>ABS</b>	Absolute	Calculates the absolute value of the source and places the result in the destination.	4-24
<b>CPT</b>	Compute	Evaluates an expression and stores the result in the destination.	4-25
<b>SWP</b>	Swap	Swaps the low and high bytes of a specified number of words in a bit, integer, ASCII, or string file.	4-28
<b>ASN</b>	Arc Sine	Takes the arc sine of a number and stores the result (in radians) in the destination.	4-29
<b>ACS</b>	Arc Cosine	Takes the arc cosine of a number and stores the result (in radians) in the destination.	4-29
<b>ATN</b>	Arc Tangent	Takes the arc tangent of a number and stores the result (in radians) in the destination.	4-30
<b>COS</b>	Cosine	Takes the cosine of a number and stores the result in the destination.	4-30
<b>LN</b>	Natural Log	Takes the natural log of the value in the source and stores it in the destination.	4-31
<b>LOG</b>	Log to the Base 10	Takes the log base 10 of the value in the source and stores the result in the destination.	4-31
<b>SIN</b>	Sine	Takes the sine of a number and stores the result in the destination.	4-32
<b>TAN</b>	Tangent	Takes the tangent of a number and stores the result in the destination.	4-32
<b>XPY</b>	X to the Power of Y	Raise a value to a power and stores the result in the destination.	4-33

## About the Math Instructions

The majority of the instructions take two input values, perform the specified arithmetic function, and output the result to an assigned memory location.

For example, both the ADD and SUB instructions take a pair of input values, add or subtract them, and place the result in the specified destination. If the result of the operation exceeds the allowable value, an overflow or underflow bit is set.

To learn more about the math instructions, we suggest that you read the Math Instructions Overview that follows.

## Math Instructions Overview

The following general information applies to math instructions.

### Entering Parameters

- Source is the address(es) of the value(s) on which the mathematical, logical, or move operation is to be performed. This can be word addresses or program constants. An instruction that has two source operands does not accept program constants in both operands.
- Destination is the address of the result of the operation. Signed integers are stored in two's complement form and apply to both source and destination parameters.

When using either an SLC 5/03 (OS301 and higher), SLC 5/04, or SLC 5/05 processor; floating point and string values (specified at the word level) are supported.

### Using Indexed Word Addresses

You have the option of using indexed word addresses for instruction parameters specifying word addresses (except for fixed and SLC 5/01 processors).

### Using Indirect Word Addresses

You have the option of using indirect word-level and bit-level addresses for instructions specifying word addresses when using an SLC 5/03 (OS302), SLC 5/04 (OS401), or SLC 5/05 processors.



## Updates to Arithmetic Status Bits

The arithmetic status bits are found in Word 0, bits 0 to 3 in the controller status file. After an instruction is executed, the arithmetic status bits in the status file are updated.

**Table 4.2 Processor Function**

With this Bit		The Controller
S:0/0	Carry (C)	sets if carry is generated; otherwise cleared.
S:0/1	Overflow (V)	indicates that the actual result of a math instruction does not fit in the designated destination.
S:0/2	Zero (Z)	indicates a 0 value after a math, move, or logic instruction.
S:0/3	Sign (S)	indicates a negative (less than 0) value after a math, move, or logic instruction.

## Overflow Trap Bit, S:5/0

Minor error bit (S:5/0) is set upon detection of a mathematical overflow or division by zero. If this bit is set upon execution of an END statement, a Temporary End (TND) instruction, or an I/O Refresh (REF), the recoverable major error code 0020 is declared.

In applications where a math overflow or divide by zero occurs, you can avoid a CPU fault by using an unlatch (OTU) instruction with address S:5/0 in your program. The rung must be between the overflow point and the END, TND, or REF statement.

## Updates to the Math Register, S:13 and S:14

Status word S:13 contains the *least* significant word of the 32-bit value of the MUL instruction. It contains the remainder for DIV and DDV instructions. It also contains the first four BCD digits for the Convert from BCD (FRD) and Convert to BCD (TOD) instructions.

Status word S:14 contains the *most* significant word of the 32-bit value of the MUL instruction. It contains the unrounded quotient for DIV and DDV instructions. It also contains the most significant digit (digit 5) for TOD and FRD instructions.

### TIP

When using floating point, S:13 and S:14 are not used.

## Using Floating Point Data File (F8:)

This file type is valid for SLC 5/03 (OS301 and higher), SLC 5/04, and SLC 5/05 processors. These are 2-word elements and addressable only at the element level.

Assign floating point addresses as follows.

**Table 4.3 Addressing Format**

<b>Format</b>	<b>Explanation</b>		
<b>Ff:e</b>	<b>F</b>	Floating Point file	
	<b>f</b>	File number. Number 8 is the default file. A file number between 9- 255 can be used if additional storage is required.	
	<b>:</b>	Element delimiter	
	<b>e</b>	Element number	Ranges from 0- 255. These are 2-word elements. Non-extended 32-bit numbers
<b>Examples:</b>	<b>F8:2</b> <b>F10:36</b>	Element 2, floating point file 8 Element 36, floating point file 10 (file 10 designated as a floating point file by the user)	

## Add (ADD)

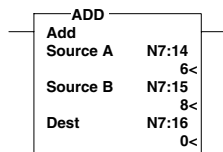

Fixed	SLC 5/01	SLC 5/02	SLC 5/03	SLC 5/04	SLC 5/05
•	•	•	•	•	•

Output Instruction

Use the ADD instruction to add one value (source A) to another value (source B) and place the result in the destination.

### Updates to Arithmetic Status Bits

The arithmetic status bits are found in Word 0, bits 0 to 3 in the status file. After an instruction is executed, the arithmetic status bits in the status file are updated.

**Table 4.4 Processor Function**

With this Bit		The Processor
S:0/0	Carry (C)	sets if carry is generated; otherwise resets (integer). For floating point, it is cleared.
S:0/1	Overflow (V)	sets if overflow is detected at destination; otherwise resets. On overflow, the minor error flag is also set. For floating point, the overflow value is placed in the destination. For an integer, the value -32,768 or 32,767 is placed in the destination. Exception: If you are using an SLC 5/02 or higher processor and have S:2/14 (math overflow selection bit) set, then the unsigned, truncated overflow remains in the destination.
S:0/2	Zero (Z)	sets if result is zero; otherwise resets.
S:0/3	Sign (S)	sets if result is negative; otherwise resets.

## Subtract (SUB)

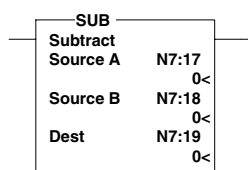

Fixed	SLC 5/01	SLC 5/02	SLC 5/03	SLC 5/04	SLC 5/05
•	•	•	•	•	•

Output Instruction

Use the SUB instruction to subtract one value (source B) from another (source A) and place the result in the destination.

### Updates to Arithmetic Status Bits

The arithmetic status bits are found in Word 0, bits 0 to 3 in the status file. After an instruction is executed, the arithmetic status bits in the status file are updated.

**Table 4.5 Processor Function**

With this Bit		The Processor
S:0/0	Carry (C)	sets if borrow is generated; otherwise resets (integer). For floating point it is cleared.
S:0/1	Overflow (V)	sets if underflow; otherwise reset. On underflow, the minor error flag is also set. For floating point, the overflow value is placed in the destination. For an integer, the value -32,768 or 32,767 is placed in the destination. Exception: If you are using an SLC 5/02 or higher processor and have S:2/14 (math overflow selection bit) set, then the unsigned, truncated overflow remains in the destination.
S:0/2	Zero (Z)	sets if result is zero; otherwise resets.
S:0/3	Sign (S)	sets if result is negative; otherwise resets.

## 32-Bit Addition and Subtraction

You have the option of performing 16-bit or 32-bit signed integer addition and subtraction. This is facilitated by status file bit S:2/14 (math overflow selection bit).

### Math Overflow Selection Bit S:2/14

Fixed	SLC 5/01	SLC 5/02	SLC 5/03	SLC 5/04	SLC 5/05
		•	•	•	•

Set this bit when you intend to use 32-bit addition and subtraction. When S:2/14 is set, and the result of an ADD, SUB, MUL, DIV, or NEG instruction cannot be represented in the destination address (due to math underflow or overflow):

- The overflow bit S:0/1 is set
- The overflow trap bit S:5/0 is set
- The destination address contains the unsigned, truncated, least significant 16 bits of the result

#### TIP

For MUL, DIV, integer, and all floating point instructions with an integer destination, when S:2/14 is set, the state change takes effect immediately.

When S:2/14 is reset (default condition), and the result of an ADD, SUB, MUL, DIV, or NEG instruction cannot be represented in the destination address (due to math underflow or overflow).

- The overflow bit S:0/1 is set
- The overflow trap bit S:5/0 is set
- The destination address contains 32767 if the result is positive or -32768 if the result is negative

#### TIP

Additionally, the SLC 5/03 and higher processors only assert the state of bit S:2/14 at the end of scan for the ADD, SUB, and NEG instructions.

Note that the status of bit S:2/14 has no effect on the DDV instruction. Also, it has no effect on the math register content when using MUL and DIV instructions.

#### TIP

The SLC 5/03 and higher processors only interrogate the S:2/14 bit upon going to the Run mode and end-of-scan. Use the Data Monitor function to make this selection prior to entering the Run mode.

### Example of 32-bit Addition

The following example shows how a 16-bit signed integer is added to a 32-bit signed integer. Remember that S:2/14 must be set for 32-bit addition.

Note that the value of the most significant 16 bits (B3:3) of the 32-bit number is increased by 1 if the carry bit S:0/0 is set and it is decreased by 1 if the number being added (B3:1) is negative.

**TIP**

The largest possible number is 2,147,483,647 (7FFF FFFF)h.

To avoid a major error from occurring at the end of the scan, you must unlatch overflow trap bit S:5/0 as shown in the example ladder diagram to follow.

**Table 4.6 Add 16-bit value B3:1 to 32-bit value B3:3 B3:2**

Add Operation		Binary	Hex	Decimal <sup>(1)</sup>
Addend	B3:3 B3:2	0000 0000 0000 0011 0001 1001 0100 0000	0003 1940	203,072
Addend	B3:1	0101 0101 1010 1000	55A8	21,928
Sum	B3:3 B3:2	0000 0000 0000 0011 0110 1110 1100 1000	0003 6EE8	225,000

<sup>(1)</sup> The programming device displays 16-bit decimal values only. The decimal value of a 32-bit integer is derived from the displayed binary or hex value. For example, 0003 1940 Hex is  $16^4 \times 3 + 16^3 \times 1 + 16^2 \times 9 + 16^1 \times 4 + 16^0 \times 0 = 203,072$ .

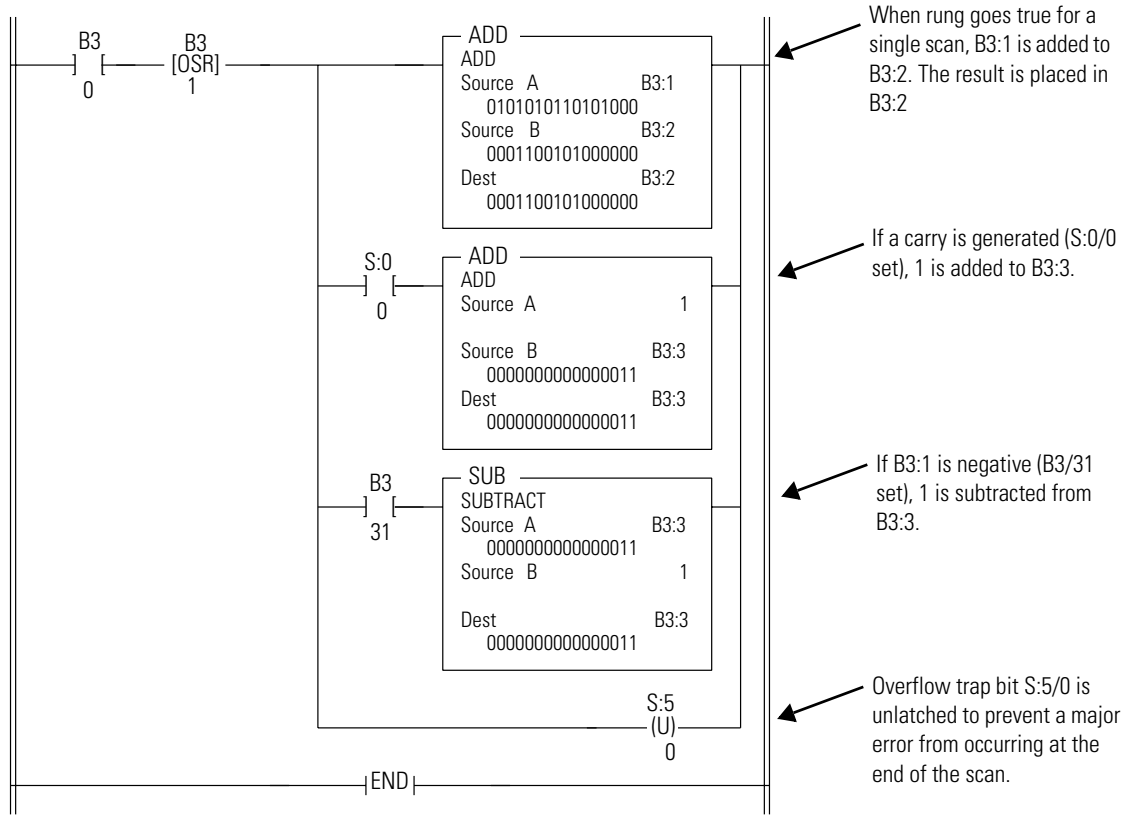

**TIP**

You can use the rung above with a DDV instruction and a counter to find the average value of B3:1.

**Multiply (MUL)**

Use the MUL instruction to multiply one value (source A) by another (source B) and place the result in the destination.

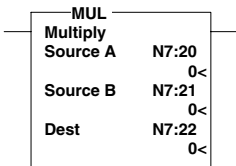

**Updates to Arithmetic Status Bits**

The arithmetic status bits are found in Word 0, bits 0 to 3 in the status file. After an instruction is executed, the arithmetic status bits in the status file are updated.

Fixed	SLC 5/01	SLC 5/02	SLC 5/03	SLC 5/04	SLC 5/05
•	•	•	•	•	•

Output Instruction

**Table 4.7 Processor Function**

With this Bit		The Processor
S:0/0	Carry (C)	always resets.
S:0/1	Overflow (V)	sets if overflow is detected at destination; otherwise resets. On overflow, the minor error flag is also set. The value -32,768 or 32,767 is placed in the destination. Exception: If you are using an SLC 5/02 or higher processor and have S:2/14 (math overflow selection bit) set, then the unsigned, truncated least significant 16-bits of the result remains in the destination. For floating point destinations, the overflow result remains in the destination.
S:0/2	Zero (Z)	sets if result is zero; otherwise resets.
S:0/3	Sign (S)	sets if result is negative; otherwise resets.

## Updates to the Math Register, S:13 and S:14

During integer operation, S:13 and S:14 contain the 32-bit signed result of the multiply instruction. This result is valid at overflow.

### TIP

For floating point operation, the math register does not change.

## Divide (DIV)

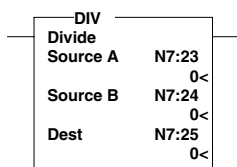

Fixed	SLC 5/01	SLC 5/02	SLC 5/03	SLC 5/04	SLC 5/05
•	•	•	•	•	•

Output Instruction

Use the DIV instruction to divide one value (source A) by another (source B). The rounded quotient is then placed in the destination. If the remainder is 0.5 or greater, round up occurs in the destination. The unrounded quotient is stored in the most significant word of the math register. The remainder is placed in the least significant word of the math register.

## Updates to Arithmetic Status Bits

The arithmetic status bits are found in Word 0, bits 0 to 3 in the status file. After an instruction is executed, the arithmetic status bits in the status file are updated.

**Table 4.8 Processor Function**

With this Bit		The Processor
S:0/0	Carry (C)	always resets.
S:0/1	Overflow (V)	sets if division by zero or overflow is detected; otherwise resets. On overflow, the minor error flag is also set. The value 32,767 is placed in the destination. Exception: If you are using an SLC1 5/02 or higher processor and have S:2/14 (math overflow selection bit) set, then the unsigned, truncated overflow remains in the destination. For floating point destinations, the overflow result remains in the destination.
S:0/2	Zero (Z)	sets if result is zero; otherwise resets; undefined if overflow is set.
S:0/3	Sign (S)	sets if result is negative; otherwise resets; undefined if overflow is set.

### Updates to the Math Registers, S:13 and S:14

During integer operation, the unrounded quotient is placed in the most significant word (S:14), the remainder is placed in the least significant word (S:13).

**TIP** For floating point operation, the math register does not change.

#### Example

The remainder of 11/2 is 0.5, so the quotient is rounded up to 6 and is stored in the destination. The unrounded quotient, which is 5, is stored in S:14 and the remainder, which is 1, is stored at S:13.

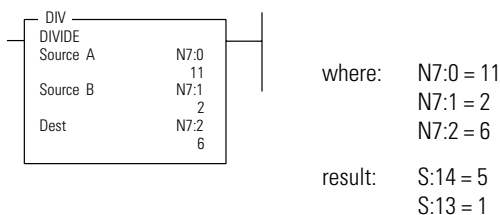



## Double Divide (DDV)

The 32-bit content of the math register is divided by the 16-bit source value and the rounded quotient is placed in the destination. If the remainder is 0.5 or greater, the destination is rounded up.

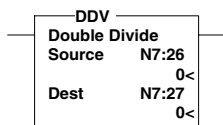

Fixed	SLC 5/01	SLC 5/02	SLC 5/03	SLC 5/04	SLC 5/05
•	•	•	•	•	•

Output Instruction

### TIP

This instruction typically follows a MUL instruction that creates a 32-bit result.

## Updates to Arithmetic Status Bits

The arithmetic status bits are found in Word 0, bits 0 to 3 in the status file. After an instruction is executed, the arithmetic status bits in the status file are updated.

**Table 4.9 Processor Function**

With this Bit		The Processor
S:0/0	Carry (C)	always resets.
S:0/1	Overflow (V)	sets if division by zero or if result is greater than 32,767 or less than -32,768; otherwise resets. On overflow, the minor error flag is also set. The value 32,767 is placed in the destination.
S:0/2	Zero (Z)	sets if result is zero; otherwise resets.
S:0/3	Sign (S)	sets if result is negative; otherwise resets; undefined if overflow is set.

## Updates to the Math Registers, S:13 and S:14

Initially contains the dividend of the DDV operation. Upon instruction execution, the unrounded quotient is placed in the most significant word of the math register. The remainder is placed in the least significant word of the math register.

## Clear (CLR)

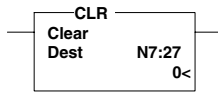

Fixed	SLC 5/01	SLC 5/02	SLC 5/03	SLC 5/04	SLC 5/05
•	•	•	•	•	•

Output Instruction

Use the CLR instruction to set the destination value of a word to zero.

### Updates to Arithmetic Status Bits

The arithmetic status bits are found in Word 0, bits 0 to 3 in the status file. After an instruction is executed, the arithmetic status bits in the status file are updated.

**Table 4.10 Processor Function**

With this Bit		The Processor
S:0/0	Carry (C)	always resets.
S:0/1	Overflow (V)	always resets.
S:0/2	Zero (Z)	always sets.
S:0/3	Sign (S)	always resets.

## Square Root (SQR)

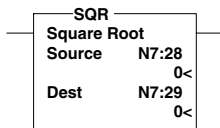

Fixed	SLC 5/01	SLC 5/02	SLC 5/03	SLC 5/04	SLC 5/05
		•	•	•	•

Output Instruction

When this instruction is evaluated as true, the square root of the absolute value of the source is calculated and the rounded result is placed in the destination.

The instruction calculates the square root of a negative number without overflow or faults. In applications where the source value may be negative, use a comparison instruction to evaluate the source value to determine if the destination may be invalid.

### Updates to Arithmetic Status Bits

The arithmetic status bits are found in Word 0, bits 0 to 3 in the status file. After an instruction is executed, the arithmetic status bits in the status file are updated.

**Table 4.11 Processor Function**

With this Bit		The Processor
S:0/0	Carry (C)	is reserved (integer). For floating point, it is always cleared.
S:0/1	Overflow (V)	always resets.
S:0/2	Zero (Z)	sets when destination value is zero.
S:0/3	Sign (S)	always resets.

## Scale with Parameters (SCP)

SCP	
Scale w/Parameters	
Input	N7:30
Input Min.	100< 0
Input Max.	32767 32767<
Scaled Min.	0 0<
Scaled Max.	10000 10000<
Output	N7:31
	0<

Fixed	SLC 5/01	SLC 5/02	SLC 5/03	SLC 5/04	SLC 5/05
			•	•	•

Output Instruction

Use the SCP instruction to produce a scaled output value that has a linear relationship between the input and scaled values. This instruction supports integer and floating point values. Use this instruction with SLC 5/03 (OS302), SLC 5/04 (OS401), and SLC 5/05 processors.

Use the following formula to convert analog input data to engineering units.

$$y = mx + b$$

Where:

y = scaled output

m = slope = (scaled MAX. - scaled MIN.) / (input MAX. - input MIN.)

x = input value

b = offset (y intercept) = scaled MIN - (input MIN. x m)

### TIP

The **Input Minimum**, **Input Maximum**, **Scaled Minimum**, and **Scaled Maximum** are used to determine the slope and offset values. The input value can go outside of the specified input limits and no ordering is required. For example, the scaled output value is not necessarily clamped between the scaled minimum and scaled maximum values.

## Entering Parameters

Enter the following parameters when programming this instruction.

- **Input value** can be a word address or an address of floating point data elements.
- **Input Minimum** and **Input Maximum** values determine the range of data that appears in the Input Value parameter. The value can be a word address, an integer constant, floating point data element, or a floating point constant.
- **Scaled Minimum** and **Scaled Maximum** values determine the range of data that appears in the Scaled Output parameter. The value can be a word address, an integer constant, floating point data element, or a floating point constant.
- **Scaled Output** value can be a word address or an address of floating point data elements.

## Updates to Arithmetic Status Bits

The arithmetic status bits are found in Word 0, bits 0 to 3 in the status file. After an instruction is executed, the arithmetic status bits in the status file are updated.

**Table 4.12 Processor Function**

With this Bit		The Processor
S:0/0	Carry (C)	always resets.
S:0/1	Overflow (V)	sets if overflow generated or an unsupported input is detected; otherwise resets.
S:0/2	Zero (Z)	sets when destination value is zero; otherwise resets.
S:0/3	Sign (S)	sets if the destination value is negative; otherwise resets.

## Application Examples

### Example 1

In the first example, an analog I/O combination module (1746-NIO4I) is in slot 1 of the chassis. A pressure transducer is connected to input 0 and we want to read the value in engineering units. The pressure transducer measures pressures from 0 to 1000 psi and provides a 0 to 10V signal to the analog module. For a 0 to 10V signal, the analog module provides a range between 0 to 32,767. The following program rung places a number between 0 and 1000 into N7:20 based on the input signal coming from the pressure transducer into the analog module.

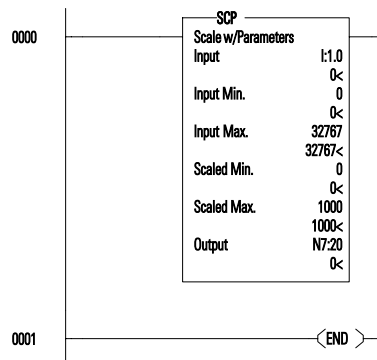

*Example 2*

In the second example, an analog I/O combination module (1746-NIO4I) is in slot 1 of the chassis. We want to control the proportional valve connected to output 0. The valve takes a 4 to 20 mA signal to control how far it opens (0 to 100%). (Assume that additional logic is present in the program that calculates how far to open the valve in percent and places a number between 0 and 100 into N7:21.) The analog module provides a 4 to 20 mA output signal for a number between 6242 to 31,208. The following program rung directs an analog output to provide a 4 to 20 mA signal to the proportional valve (N7:21), based on a number between 0 and 100.

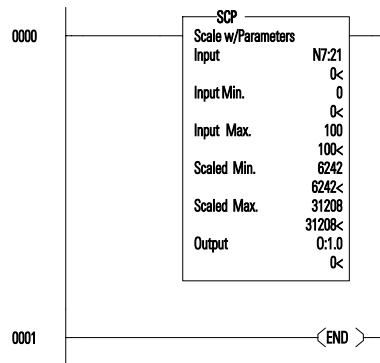

**Scale Data (SCL)**

When this instruction is true, the value at the source address is multiplied by the rate value. The rounded result is added to the offset value and placed in the destination.

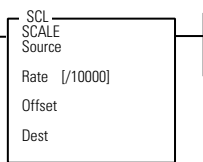

*Example*

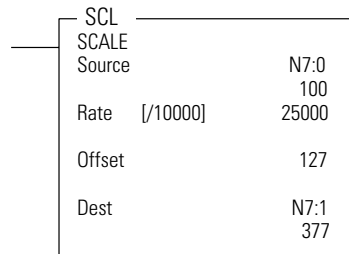

The source 100 is multiplied by 25000 and divided by 10000 and added to 127. The result, 377, is placed in the destination.

Fixed	SLC 5/01	SLC 5/02	SLC 5/03	SLC 5/04	SLC 5/05
		•	•	•	•

Output Instruction

**TIP**

Anytime an underflow or overflow occurs in the destination file, minor error bit S:5/0 must be reset by the program. This must occur before the end of the current scan to prevent major error code 0020 from being declared. This instruction can overflow before the offset is added.

Note that the term rate is sometimes referred to as *slope*. The rate function is limited to the range -3.2768 to 3.2767. For example, -32768/10000 to +32767/10000.

## Entering Parameters

The value for the following parameters is between -32,768 to 32,767.

- Source can be either a constant or a word address
- Rate (or slope) is the positive or negative value you enter divided by 10,000. It can be either a constant or a word address
- Offset can be either a constant or a word address

## Updates to Arithmetic Status Bits

The arithmetic status bits are found in Word 0, bits 0 to 3 in the status file. After an instruction is executed, the arithmetic status bits in the status file are updated.

**Table 4.13 Processor Function**

With this Bit		The Processor
S:0/0	Carry (C)	is reserved.
S:0/1	Overflow (V)	sets if an overflow is detected; otherwise resets. On overflow, minor error bit S:5/0 is also set and the value -32,768 or 32,767 is placed in the destination. The presence of an overflow is checked before and after the offset value is applied. <sup>(1)</sup>
S:0/2	Zero (Z)	sets when destination value is zero.
S:0/3	Sign (S)	sets if the destination value is negative; otherwise resets.

<sup>(1)</sup> If the result of the Source times the Rate, divided by 10000, is greater than 32767, the SCL instruction overflows, causing error 0020 (Minor Error Bit), and places 32767 in the Destination. This occurs regardless of the current offset.

## Application Example 1 - Converting 4 to 20 mA Analog Input Signal to PID Process Variable

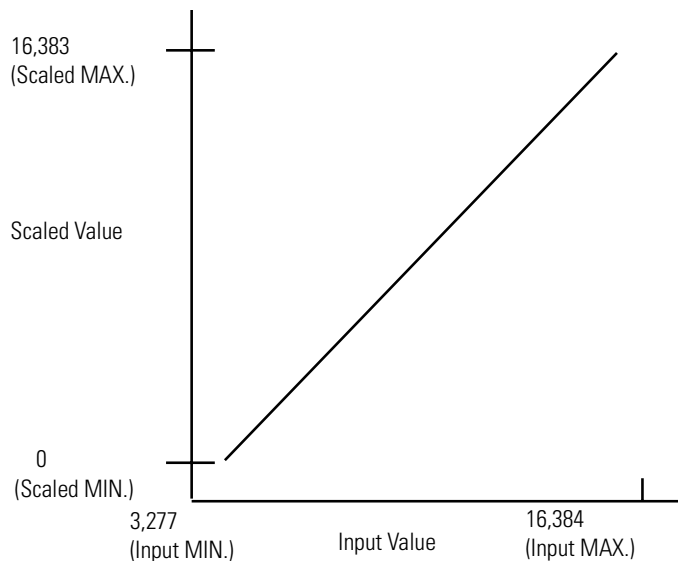

### *Calculating the Linear Relationship*

Use the following equations to express the linear relationship between the input value and the resulting scaled value.

$$\text{Scaled value} = (\text{Input Value} \times \text{Rate}) + \text{Offset}$$

$$\text{Rate} = (\text{Scaled MAX.} - \text{Scaled MIN.}) / (\text{Input MAX.} - \text{Input MIN.})$$

$$(16,383 - 0) / (16,384 - 3,277) = 1.249 \text{ (or } 12,490/10000)$$

$$\text{Offset} = \text{Scaled MIN.} - (\text{Input MIN.} \times \text{Rate})$$

$$0 - (3,277 \times 1.249) = -4093$$

## Application Example 2 - Scaling an Analog Input to Control an Analog Output

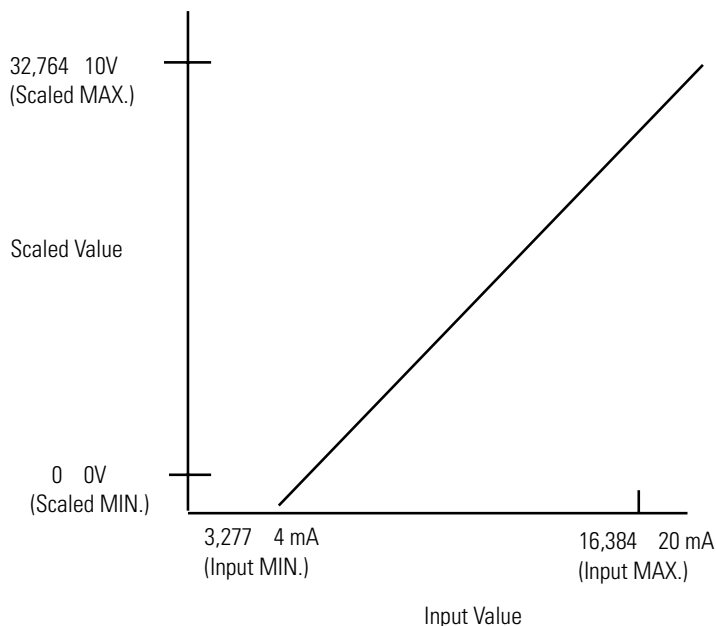

### Calculating the Linear Relationship

Use the following equations to calculate the scaled units.

**Scaled value** = (Input Value X Rate) + Offset

Rate = (Scaled MAX. - Scaled MIN.) / (Input MAX. - Input MIN.)

$$(32,764 - 0) / (16,384 - 3277) = 2.4997 \text{ (or } 24,997/10000)$$

Offset = Scaled MIN. - (Input MIN. x rate)

$$0 - (3277 \times 2.4997) = -8192$$

The above offset and rate values are correct for the SCL instruction. However, if the input exceeds 13,107, the instruction overflows and sets S:5/0 math overflow bit. For example:

$$17 \text{ mA} = 13,926 \times 2.2997 = 34,810 \text{ (actual overflow)}$$

$$34,810 - 8192 = 26,618$$

To avoid an overflow, we recommend shifting the linear relationship along the input value axis and reduce the values.



Notice that an overflow occurred even though the final value was correct. This happens because the overflow condition occurred during the rate calculation.

The following graph shows the shifted linear relationship. The input minimum value of 3,277 is subtracted from the input maximum value of 16,384, resulting in the value of 13,107.

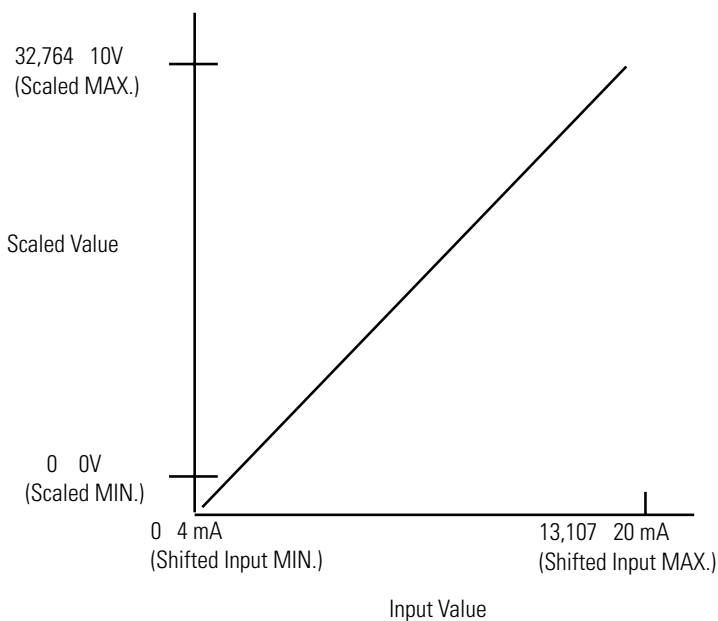

### *Calculating the Shifted Linear Relationship*

Use the following equations to calculate the scaled units.

$$\text{Scaled value} = (\text{Input Value} \times \text{Rate}) + \text{offset}$$

$$\text{Rate} = \frac{\text{Scaled MAX.} - \text{Scaled MIN.}}{\text{Input MAX.} - \text{Input MIN.}}$$

$$\frac{32,764 - 0}{13,107 - 0} = 2.4997 \text{ (or } 24,997/10000)$$

$$\text{Offset} = \text{Scaled MIN.} - (\text{Input MIN.} \times \text{Rate})$$

$$0 - (0 \times 2.4997) = 0$$

In this example, the SCL instruction is entered in the ladder logic program as follows.

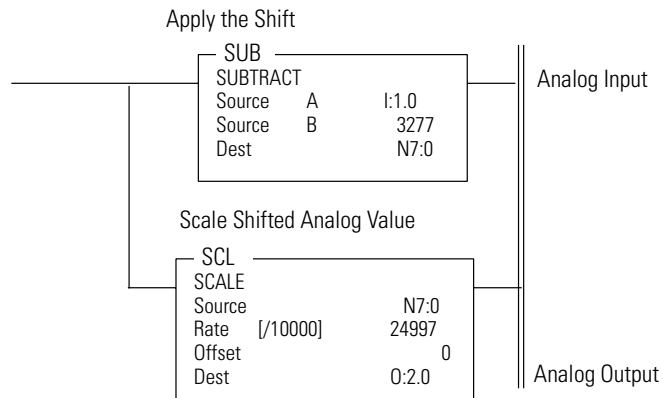

## Ramp Instruction (RMP)

The Ramp (RMP) instruction provides the ability to create linear, acceleration, deceleration, and “S” curve ramp output data wave forms. This instruction provides a means to ramp analog outputs when using them to control devices such as valves.

The instruction has the following parameters.

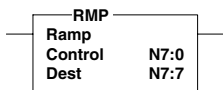

Fixed	SLC 5/01	SLC 5/02	SLC 5/03	SLC 5/04	SLC 5/05
			•	•	•

Output Instruction

- Control - Control Block is an integer file address that is user selectable. It is a 7-element file, which consists of the following bits and registers:
  - Word 0 Bit 15 - Enable bit, follows rung state of ramp instruction.
  - Word 0 Bit 14 - Ramping bit, when set, RMP function is working.
  - Word 0 Bit 13 - Done bit, set once the RMP function completes (current time = desired time).
  - Word 0 Bit 12 - Error bit, set if invalid parameters are specified.
  - Word 0 Bits 0 to 7 - Ramp Algorithm Type.
  - Word 1 Desired Time - This word defines the time duration of the ramp, in timebase units (1 second or 10 milliseconds). (integer value, valid range = +1 to +32767)
  - Word 2 Current Time - This word is the current time position of ramp, in timebase units (1 second or 10 milliseconds). The instruction updates the current time when the rung state is true. (integer value, valid range = 0 to +32767)
  - Word 3 Beginning Output Value - Starting point of ramp (integer value, valid range = -32768 to +32767).
  - Word 4 Ending Output Value - Ending point of ramp (integer value, valid range = -32768 to +32767)
  - Words 5 and 6 - These words are for internal use only.
- Destination - The Destination is any user defined integer word.

**Table 4.14 Ramp Instruction Control Structure**

	15	14	13	12	11	10	9	8	7	6	5	4	3	2	1	0
Word 0	EN	RMP	DN	ER					Ramp Algorithm Type							
									0	0	0	TB <sup>(1)</sup>	0	0	Waveform <sup>(2)</sup>	
Word 1	Desired Time															
Word 2	Current Time															
Word 3	Beginning Output Value															
Word 4	Ending Output Value															
Words 5 and 6	Internal use only															

<sup>(1)</sup> TB = 0, Timebase = 0.01 seconds  
 TB = 1, Timebase = 1.0 second

<sup>(2)</sup> Waveform = 00 Linear  
 Waveform = 01 Acceleration  
 Waveform = 10 Deceleration  
 Waveform = 11 "S" Curve

The following illustrations show Linear Ramp, Acceleration, Deceleration and "S" Curve Ramp waveforms.

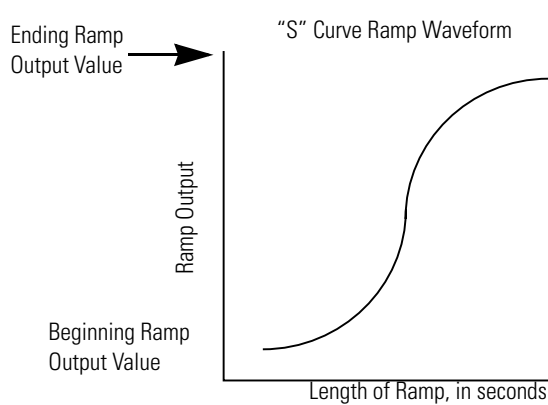
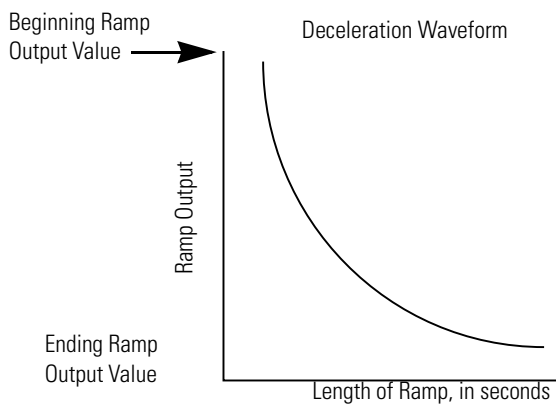
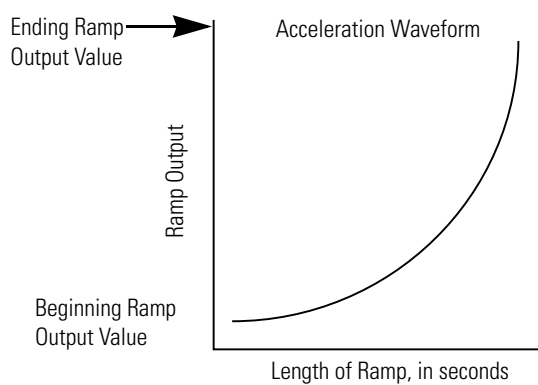
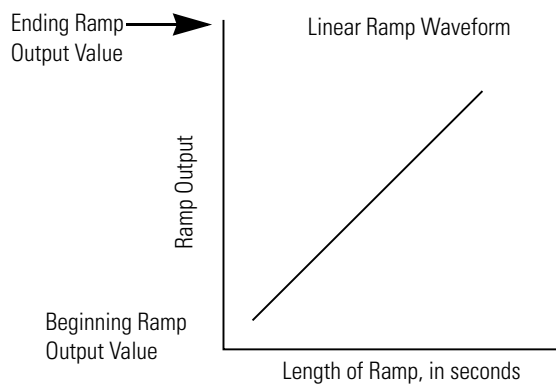

## Instruction Operation

When the rung state is true all parameters are validated to be in range. If the parameters are valid, the ramp function places the calculated output value in the destination register. The parameters are validated for every scan when the rung state is true. When the Ramp instruction is scanned and the rung state is true, the current time is updated, the destination value is calculated, and done condition is checked.

---

**ATTENTION**

Changing words 1 through 4 during instruction execution causes loss of resolution of one unit of measurement (1 second or 0.01 seconds depending on ramp). If these values are modified during execution the destination value automatically recalculates for the new value on the next scan.

---

**ATTENTION**

Modification of words 5 and 6 could result in unpredictable operation, possibly causing equipment damage and/or injury to personnel.

---

When the rung state is false, the current time is not updated and the destination value is not calculated. When the rung state sees another false to true change the current time is determined from the last updated position. An accuracy of +/- one unit (1 second or 0.01 seconds depending on ramp) or one scan, whichever is larger, can be expected for a false-to-true or true-to-false rung transition.

The Ramp instruction is retentive. If a Ramp instruction is executing when a power cycle occurs, the instruction continues to operate starting with the last updated position. The accuracy is limited to one unit or one scan, whichever is larger. Ramp instructions can be cascaded.

## RMP Equation

The Ramp instruction is defined based on the following equations.

Linear:  $Output = (E - S) \times \frac{P}{L} + S$

Acceleration:  $Output = (E - S) \times \frac{P}{L} \times \frac{P}{L} + S$

Deceleration:  $Output = (E - S) \times \left(1 - \frac{L - P}{L} \times \frac{L - P}{L}\right) + S$

"S" Curve:  $Output = (E - S) \times 2 \times \frac{P}{L} \times \frac{P}{L} + S$        $Output = (E - S) \times \left(1 - 2 \times \frac{L - P}{L} \times \frac{L - P}{L}\right) + S$

While  $0 \leq P \leq L/2$

While  $(L/2) < P < L$

- S = the Beginning Output value
- E = the Ending Output value
- P = the Current Time
- L = the Overall Time
- Output = the RMP output value

## Continuous Operation

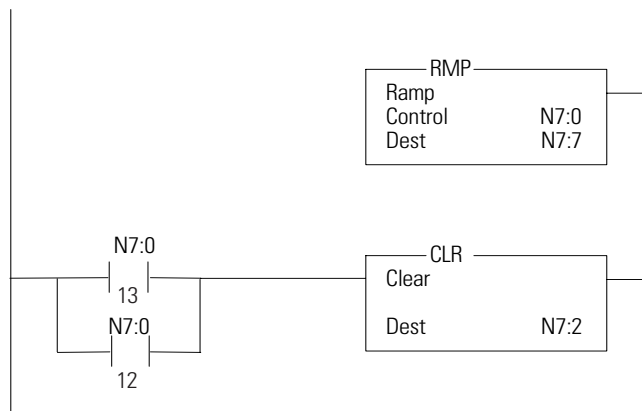

## Absolute (ABS)

Use the ABS instruction to calculate the absolute value of the Source and place the result in the Destination. This instruction supports integer and floating point values. Use this instruction with SLC 5/03 (OS302), SLC 5/04 (OS401), and SLC 5/05 processors.

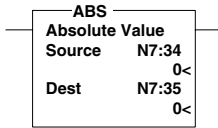

Fixed	SLC 5/01	SLC 5/02	SLC 5/03	SLC 5/04	SLC 5/05
			•	•	•

Output Instruction

### Entering Parameters

Enter the following parameters when programming this instruction.

- Source can be a word address, an integer constant, floating point data element, or a floating point constant
- Destination can only be a word address or a floating point data element

### Updates to Arithmetic Status Bits

The arithmetic status bits are found in Word 0, bits 0 to 3 in the status file. After an instruction is executed, the arithmetic status bits in the status file are updated

**Table 4.15 Processor Function**

With this Bit		The Processor
S:0/0	Carry (C)	always resets.
S:0/1	Overflow (V)	always resets with a floating point value; sets if the input is -32,768 (integer value).
S:0/2	Zero (Z)	sets when destination value is zero; otherwise resets.
S:0/3	Sign (S)	always resets.

## Compute (CPT)

The CPT instruction performs copy, arithmetic, logical, and conversion operations. You define the operation in the Expression and the result is written in the Destination. The CPT uses functions to operate on one or more values in the Expression to perform operations such as:

- converting from one number format to another.
- manipulating numbers.
- performing trigonometric functions.

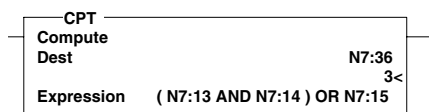

Use this instruction with SLC 5/03 (OS302), SLC 5/04 (OS401), and SLC 5/05 processors.

Fixed	SLC 5/01	SLC 5/02	SLC 5/03	SLC 5/04	SLC 5/05
			•	•	•

Output Instruction

Instructions that can be used in the Expression include:

+, -, \*, | (DIV), SQR, - (NEG), NOT, XOR, OR, AND, TOD, FRD, LN, TAN, ABS, DEG, RAD, SIN, COS, ATN, ASN, ACS, LOG, and \*\* (XPY).

### TIP

The execution time of a CPT instruction is longer than a single arithmetic operation and uses more instruction words.

## Entering Parameters

Enter the following parameters when programming this instruction.

- Destination can be a word address or the address of a floating-point data element
- Expression is zero or more lines, with up to 28 characters per line, up to 255 characters

## Updates to Arithmetic Status Bits

The arithmetic status bits are found in Word 0, bits 0 to 3 in the status file. After an instruction is executed, the arithmetic status bits in the status file are updated.

**Table 4.16 Processor Function**

With this Bit		The Processor
S:0/0	Carry (C)	sets based on the result of the last instruction in the Expression.
S:0/1	Overflow (V)	sets any time an overflow occurs during the evaluation of the Expression.
S:0/2	Zero (Z)	sets based on the result of the last instruction in the Expression.
S:0/3	Sign (S)	sets based on the result of the last instruction in the Expression.

The above bits are cleared at the start of the CPT instruction. Status file bit S:34/2 is for special handling of the math status bits when using floating point.

## Application Example

This application example uses Pythagorean's theorem to find the length of the long leg of a triangle, knowing the two other leg lengths. Use the following equation.

$$c^2 = a^2 + b^2$$

$$\text{where } c = \sqrt{(a^2 + b^2)}$$

$$N10:0 = \sqrt{(N7:1)^2 + (N7:2)^2}$$



Rung 2:0 uses standard math instructions to implement Pythagorean's theorem. Rung 2:1 uses the CPT instruction to obtain the same calculation.

```

Rung 2:0
-----+-----+
+XPY-----+
+X TO POWER OF Y +--+
|Source A      N7:1|
|              3   |
|Source B      2   |
|              |
|Dest          N7:3|
|              0   |
+-----+
+XPY-----+
+X TO POWER OF Y +--+
|Source A      N7:2|
|              4   |
|Source B      2   |
|              |
|Dest          N7:4|
|              0   |
+-----+
+ADD-----+
+ADD           +--+
|Source A      N7:3|
|              0   |
|Source B      N7:4|
|              0   |
|Dest          N7:5|
|              0   |
+-----+
+SQR-----+
+SQUARE ROOT   +--+
|Source        N7:5|
|              0   |
|Dest          N7:0|
|              0   |
+-----+
Rung 2:1
-----+-----+
+CPT-----+
+COMPUTE      +--+
|Dest          N10:0|
|              0   |
|Expression    |
|SQR ((N7:1 ** 2) + (N7:2 **
|2))          |
+-----+
Rung 2:2
-----+-----+
+END+-----+

```

## Swap (SWP)

Use this instruction to swap the low and high bytes of a specified number of words in a bit, integer, ASCII, or string file. Use this instruction with SLC 5/03 (OS302), SLC 5/04 (OS401), and SLC 5/05 processors.

### Entering Parameters

Enter the following parameters when programming this instruction.

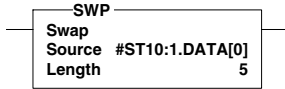

Fixed	SLC 5/01	SLC 5/02	SLC 5/03	SLC 5/04	SLC 5/05
			•	•	•

Output Instruction

- Source can only be an indexed word address
- Length refers to the number of words to be swapped, regardless of the file type. The address is limited to integer constants. For bit, integer, and ASCII file types, the length range is 1 to 128. For the string file type, the length range is 1 to 41. Note that this instruction is restricted to a single string element and cannot cross a string element boundary.

The following example shows how the SWP instruction works.

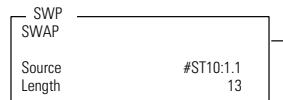

Before:

ST10:1 = abcdefghijklmnopqrstuvwxyz

After

ST10:1 = badcfehgilknmporqtsvuxwzy

## Arc Sine (ASN)

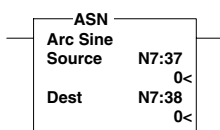

Fixed	SLC 5/01	SLC 5/02	SLC 5/03	SLC 5/04	SLC 5/05
			•	•	•

Output Instruction

Use the ASN instruction to take the arc sine of a number and store the result (in radians) in the destination. The source must be greater than or equal to -1 and less than or equal to 1. The resulting value in the destination is always greater than or equal to  $-\pi/2$  and less than or equal to  $\pi/2$ , where  $\pi = 3.141592$ . Use this instruction with SLC 5/03 (OS302), SLC 5/04 (OS401), and SLC 5/05 processors.

### Updates to Arithmetic Status Bits

The arithmetic status bits are found in Word 0, bits 0 to 3 in the status file. After an instruction is executed, the arithmetic status bits in the status file are updated.

**Table 4.17 Processor Function**

With this Bit		The Processor
S:0/0	Carry (C)	always resets.
S:0/1	Overflow (V)	sets if an overflow is generated or an unsupported input is detected; otherwise resets.
S:0/2	Zero (Z)	sets if the result is zero; otherwise resets.
S:0/3	Sign (S)	sets if the result is negative; otherwise resets.

## Arc Cosine (ACS)

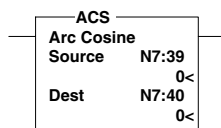

Fixed	SLC 5/01	SLC 5/02	SLC 5/03	SLC 5/04	SLC 5/05
			•	•	•

Output Instruction

Use the ACS instruction to take the arc cosine of a number (source in radians) and store the result (in radians) in the destination. The source must be greater than or equal to -1 and less than or equal to 1. The resulting value in the destination is always greater than or equal to 0 and less than or equal to  $\pi$ , where  $\pi = 3.141592$ . Use this instruction with SLC 5/03 (OS302), SLC 5/04 (OS401), and SLC 5/05 processors.

### Updates to Arithmetic Status Bits

The arithmetic status bits are found in Word 0, bits 0 to 3 in the status file. After an instruction is executed, the arithmetic status bits in the status file are updated.

**Table 4.18 Processor Function**

With this Bit		The Processor
S:0/0	Carry (C)	always resets.
S:0/1	Overflow (V)	sets if an overflow is generated or an unsupported input is detected; otherwise resets.
S:0/2	Zero (Z)	sets if the result is zero; otherwise resets.
S:0/3	Sign (S)	always resets.

## Arc Tangent (ATN)

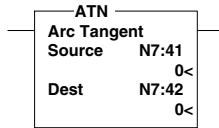

Fixed	SLC 5/01	SLC 5/02	SLC 5/03	SLC 5/04	SLC 5/05
			•	•	•

Output Instruction

Use the ATN instruction to take the arc tangent of a number (source) and store the result (in radians) in the destination. The resulting value in the destination is always greater than or equal to  $-\pi/2$  and less than or equal to  $\pi/2$ , where  $\pi = 3.141592$ . Use this instruction with SLC 5/03 (OS302), SLC 5/04 (OS401), and SLC 5/05 processors.

### Updates to Arithmetic Status Bits

The arithmetic status bits are found in Word 0, bits 0 to 3 in the status file. After an instruction is executed, the arithmetic status bits in the status file are updated.

**Table 4.19 Processor Function**

With this Bit		The Processor
S:0/0	Carry (C)	always resets.
S:0/1	Overflow (V)	sets if an overflow is generated or an unsupported input is detected; otherwise resets.
S:0/2	Zero (Z)	sets if the result is zero; otherwise resets.
S:0/3	Sign (S)	sets if the result is negative; otherwise resets.

## Cosine (COS)

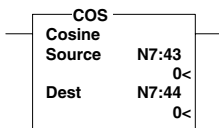

Fixed	SLC 5/01	SLC 5/02	SLC 5/03	SLC 5/04	SLC 5/05
			•	•	•

Output Instruction

Use the COS instruction to take the cosine of a number (source in radians) and store the result in the destination. The source must be greater than or equal to  $-205887.4$  and less than or equal to  $205887.4$ . The greatest accuracy is achieved when the source is greater than  $-2\pi$  and less than  $2\pi$ , where  $\pi = 3.141592$ . The resulting value in the destination is always greater than or equal to  $-1$  and less than or equal to  $1$ . Use this instruction with SLC 5/03 (OS302), SLC 5/04 (OS401), and SLC 5/05 processors.

### Updates to Arithmetic Status Bits

The arithmetic status bits are found in Word 0, bits 0 to 3 in the status file. After an instruction is executed, the arithmetic status bits in the status file are updated.

**Table 4.20 Processor Function**

With this Bit		The Processor
S:0/0	Carry (C)	always resets.
S:0/1	Overflow (V)	sets if an overflow is generated or an unsupported input is detected; otherwise resets.
S:0/2	Zero (Z)	sets if the result is zero; otherwise resets.
S:0/3	Sign (S)	sets if the result is negative; otherwise resets.

## Natural Log (LN)

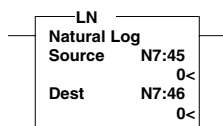

Fixed	SLC 5/01	SLC 5/02	SLC 5/03	SLC 5/04	SLC 5/05
			•	•	•

Output Instruction

Use the LN instruction to take the natural log of the value in the source and store the result in the destination. The source must be greater than zero. The resulting value in the destination is always greater than or equal to -87.33654 and less than or equal to 88.72284. Use this instruction with SLC 5/03 (OS302), SLC 5/04 (OS401), and SLC 5/05 processors.

### Updates to Arithmetic Status Bits

The arithmetic status bits are found in Word 0, bits 0 to 3 in the status file. After an instruction is executed, the arithmetic status bits in the status file are updated.

**Table 4.21 Processor Function**

With this Bit		The Processor
S:0/0	Carry (C)	always resets.
S:0/1	Overflow (V)	sets if an overflow is generated or an unsupported input is detected; otherwise resets.
S:0/2	Zero (Z)	sets if the result is zero; otherwise resets.
S:0/3	Sign (S)	sets if the result is negative; otherwise resets.

## Log to the Base 10 (LOG)

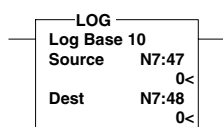

Fixed	SLC 5/01	SLC 5/02	SLC 5/03	SLC 5/04	SLC 5/05
			•	•	•

Output Instruction

Use the LOG instruction to take the log base 10 of the value in the source and store the result in the destination. The source must be greater than zero. The resulting value in the destination is always greater than or equal to -37.92978 and less than or equal to 38.53184. Use this instruction with SLC 5/03 (OS302), SLC 5/04 (OS401), and SLC 5/05 processors.

### Updates to Arithmetic Status Bits

The arithmetic status bits are found in Word 0, bits 0 to 3 in the status file. After an instruction is executed, the arithmetic status bits in the status file are updated.

**Table 4.22 Processor Function**

With this Bit		The Processor
S:0/0	Carry (C)	always resets.
S:0/1	Overflow (V)	sets if an overflow is generated or an unsupported input is detected; otherwise resets.
S:0/2	Zero (Z)	sets if the result is zero; otherwise resets.
S:0/3	Sign (S)	sets if the result is negative; otherwise resets.

## Sine (SIN)

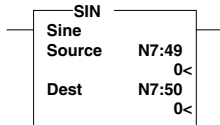

Fixed	SLC 5/01	SLC 5/02	SLC 5/03	SLC 5/04	SLC 5/05
			•	•	•

Output Instruction

Use the SIN instruction to take the sine of a number (source in radians) and store the result in the destination. The source must be greater than or equal to -205887.4 and less than or equal to 205887.4. The greatest accuracy is achieved when the source is greater than -2 Pi and less than 2 Pi, where Pi = 3.141592. The resulting value in the destination is always greater than or equal to -1 and less than or equal to 1. Use this instruction with SLC 5/03 (OS302), SLC 5/04 (OS401), and SLC 5/05 processors.

### Updates to Arithmetic Status Bits

The arithmetic status bits are found in Word 0, bits 0 to 3 in the status file. After an instruction is executed, the arithmetic status bits in the status file are updated.

**Table 4.23 Processor Function**

With this Bit		The Processor
S:0/0	Carry (C)	always resets.
S:0/1	Overflow (V)	sets if an overflow is generated or an unsupported input is detected; otherwise resets.
S:0/2	Zero (Z)	sets if the result is zero; otherwise resets.
S:0/3	Sign (S)	sets if the result is negative; otherwise resets.

## Tangent (TAN)

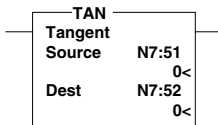

Fixed	SLC 5/01	SLC 5/02	SLC 5/03	SLC 5/04	SLC 5/05
			•	•	•

Output Instruction

Use the TAN instruction to take the tangent of a number (source in radians) and store the result in the destination. The value in the source must be greater than or equal to -102943.7 and less than or equal to 102943.7. The greatest accuracy is achieved when the source is greater than -2 Pi and less than 2 Pi, where Pi = 3.141592. The resulting value in the destination is either a real number or infinity. Use this instruction with SLC 5/03 (OS302), SLC 5/04 (OS401), and SLC 5/05 processors.

### Updates to Arithmetic Status Bits

The arithmetic status bits are found in Word 0, bits 0 to 3 in the status file. After an instruction is executed, the arithmetic status bits in the status file are updated.

**Table 4.24 Processor Function**

With this Bit		The Processor
S:0/0	Carry (C)	always resets.
S:0/1	Overflow (V)	sets if an overflow is generated or an unsupported input is detected; otherwise resets.
S:0/2	Zero (Z)	sets if the result is zero; otherwise resets.
S:0/3	Sign (S)	sets if the result is negative; otherwise resets.

## X to the Power of Y (XPY)

Use the XPY instruction to raise a value (source A) to a power (source B) and store the result in the destination. If the value in source A is negative, the exponent (source B) should be a whole number. If it is not a whole number, the overflow bit is set and the absolute value of the base is used in the calculation. Use this instruction with SLC 5/03 (OS302), SLC 5/04 (OS401), and SLC 5/05 processors.

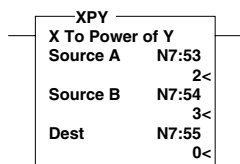

The XPY instruction uses the following algorithm.

$$XPY = 2^{**} (Y * \log_2 (X))$$

If any of the intermediate operations in this algorithm produce an overflow, the Arithmetic Overflow Status bit (S:0/1) is set.

Fixed	SLC 5/01	SLC 5/02	SLC 5/03	SLC 5/04	SLC 5/05
			•	•	•

Output Instruction

## Updates to Arithmetic Status Bits

The arithmetic status bits are found in Word 0, bits 0 to 3 in the status file. After an instruction is executed, the arithmetic status bits in the status file are updated.

**Table 4.25 Processor Function**

With this Bit		The Processor
S:0/0	Carry (C)	always resets.
S:0/1	Overflow (V)	sets if an overflow is generated or an unsupported input is detected; otherwise resets.
S:0/2	Zero (Z)	sets if the result is zero; otherwise resets.
S:0/3	Sign (S)	sets if the result is negative; otherwise resets.

**Notes:**



## Data Handling Instructions

This chapter contains general information about the data handling instructions and explains how they function in your application program. Each of the instructions includes information on:

- what the instruction symbol looks like.
- how to use the instruction.

**Table 5.1 Data Handling Instructions**

Instruction		Purpose	Page
Mnemonic	Name		
<b>TOD</b>	Convert to BCD	Converts the integer source value to BCD format and stores it in the destination.	5-2
<b>FRD</b>	Convert from BCD	Converts the BCD source value to an integer and stores it in the destination.	5-5
<b>DEG</b>	Convert from Radians to Degrees	Converts radians (source) to degrees and stores the result in the destination.	5-8
<b>RAD</b>	Convert from Degrees to Radians	Converts degrees (source) to radians and stores the result in the destination.	5-9
<b>DCD</b>	Decode 4 to 1 of 16	Decodes a 4-bit value (0 to 15), turning on the corresponding bit in the 16-bit destination.	5-10
<b>ENC</b>	Encode 1 of 16 to 4	Encodes a 16-bit source to a 4-bit value. Searches the source from the lowest to the highest bit, and looks for the first set bit. The corresponding bit position is written to the destination as an integer.	5-11
<b>COP and FLL</b>	Copy File and Fill File	The COP instruction copies data from the source file to the destination file. The FLL instruction loads a source value into each position in the destination file.	5-13
<b>MOV</b>	Move	Moves the source value to the destination.	5-17
<b>MVM</b>	Masked Move	Moves data from a source location to a selected portion of the destination.	5-18
<b>AND</b>	And	Performs a bitwise AND operation.	5-20
<b>OR</b>	Or	Performs a bitwise inclusive OR operation.	5-21
<b>XOR</b>	Exclusive Or	Performs a bitwise exclusive OR operation.	5-22
<b>NOT</b>	Not	Performs a NOT operation.	5-23
<b>NEG</b>	Negate	Changes the sign of the source and stores it in the destination.	5-24
<b>FFL and FFU</b>	FIFO Load and FIFO Unload	The FFL instruction loads a word into a FIFO stack on successive false-to-true transitions. The FFU unloads a word from the stack on successive false- to-true transitions. The first word loaded is the first to be unloaded.	5-26
<b>LFL and LFU</b>	LIFO Load and LIFO Unload	The LFL instruction loads a word into a LIFO stack on successive false-to-true transitions. The LFU unloads a word from the stack on successive false-to-true transitions. The last word loaded is the first to be unloaded.	5-28

## Convert to BCD (TOD)

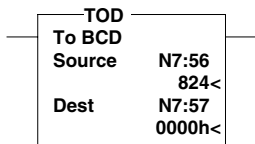

Fixed	SLC 5/01	SLC 5/02	SLC 5/03	SLC 5/04	SLC 5/05
•	•	•	•	•	•

Output Instruction

Use this instruction to convert 16-bit integers into BCD values.

With Fixed and SLC 5/01 processors, the destination can only be the math register. With SLC 5/02 and higher processors, the destination parameter can be a word address in any data file, or it can be the math register, S:13 and S:14.

If the integer value you enter is negative, the absolute value of the number is used for conversion.

### Updates to Arithmetic Status Bits

The arithmetic status bits are found in Word 0, bits 0 to 3 in the status file. After an instruction is executed, the arithmetic status bits in the status file are updated.

**Table 5.2 Processor Function**

With this Bit		The Processor
S:0/0	Carry (C)	always resets.
S:0/1	Overflow (V)	sets if the BCD result is larger than 9999. Overflow results in a minor error.
S:0/2	Zero (Z)	sets if destination value is zero.
S:0/3	Sign (S)	sets if the source word is negative; otherwise resets.

## Updates to the Math Register, S:13 and S:14

Contains the 5-digit BCD result of the conversion. This result is valid at overflow.

### Example 1

The integer value 9760 stored at N7:3 is converted to BCD and the BCD equivalent is stored in N10:0. The maximum BCD value possible is 9999.

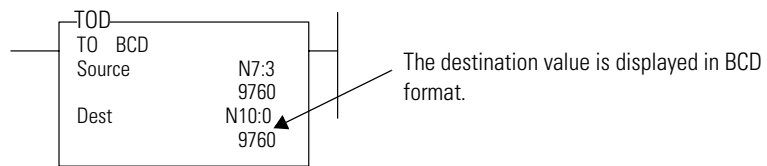

<b>9</b>	<b>7</b>	<b>6</b>	<b>0</b>	<b>N7:3</b>	<b>Decimal</b>	0010	0110	0010	0000
↓	↓	↓	↓						
<b>9</b>	<b>7</b>	<b>6</b>	<b>0</b>	<b>N10:0</b>	<b>4-digit BCD</b>	1001	0111	0110	0000

### Example 2

The integer value 32760 stored at N7:3 is converted to BCD. The 5-digit BCD value is stored in the math register. The lower 4 digits of the BCD value is moved to output word O:2 and the remaining digit is moved through a mask to output word O:3.

When using the math register as the destination parameter in the TOD instruction, the maximum BCD value possible is 32767.

#### TIP

However, for BCD values above 9999, the overflow bit is set, resulting in minor error bit S:5/0 also being set. Your ladder program can unlatch S:5/0 before the end of the scan to avoid major error 0020, as done in this example.

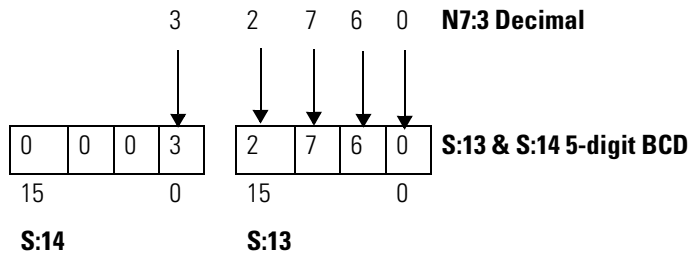

This example will output the absolute value (0 to 32767) contained in N7:3 as 5 BCD digits in output slots 2 and 3.

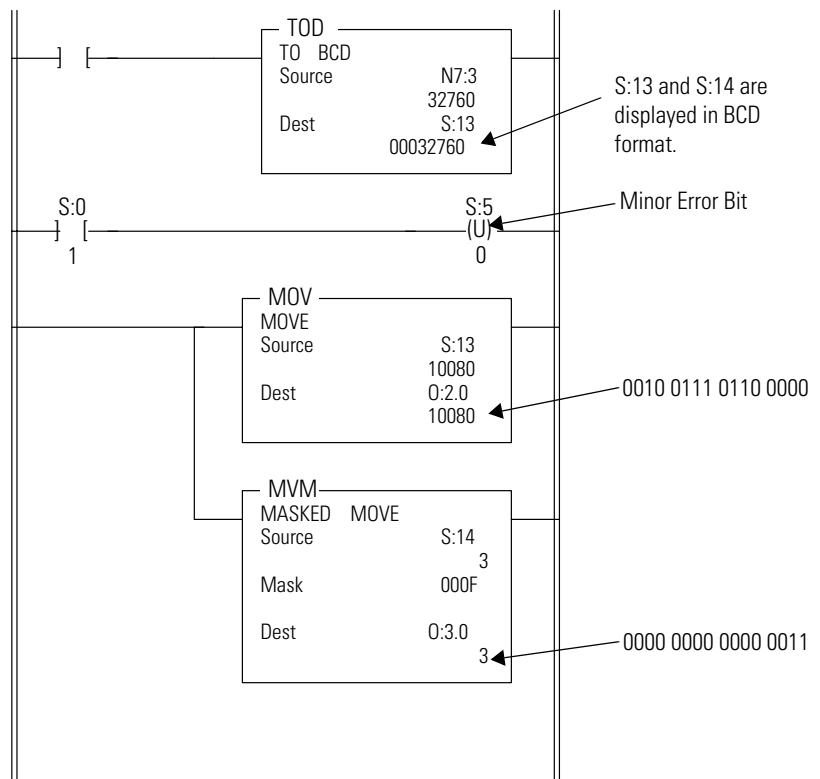

## Convert from BCD (FRD)

Use this instruction to convert BCD values to integer values. With Fixed and SLC 5/01 processors, the source can only be the math register. With SLC 5/02 and higher processors, the source parameter can be a word address in any data file, or it can be the math register, S:13.

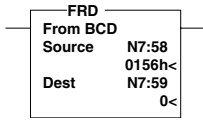

Fixed	SLC 5/01	SLC 5/02	SLC 5/03	SLC 5/04	SLC 5/05
•	•	•	•	•	•

Output Instruction

## Updates to Arithmetic Status Bits

The arithmetic status bits are found in Word 0, bits 0 to 3 in the status file. After an instruction is executed, the arithmetic status bits in the status file are updated.

**Table 5.3 Processor Function**

With this Bit		The Processor
S:0/0	Carry (C)	always resets.
S:0/1	Overflow (V)	sets if non-BCD value is contained at the source or the value to be converted is greater than 32,767; otherwise reset. Overflow results in a minor error.
S:0/2	Zero (Z)	sets if destination value is zero.
S:0/3	Sign (S)	always resets.

### TIP

We recommend that you always provide ladder logic filtering of all BCD input devices prior to performing the FRD instruction. The slightest difference in point-to-point input filter delay can cause the FRD instruction to overflow due to the conversion of a non-BCD digit.

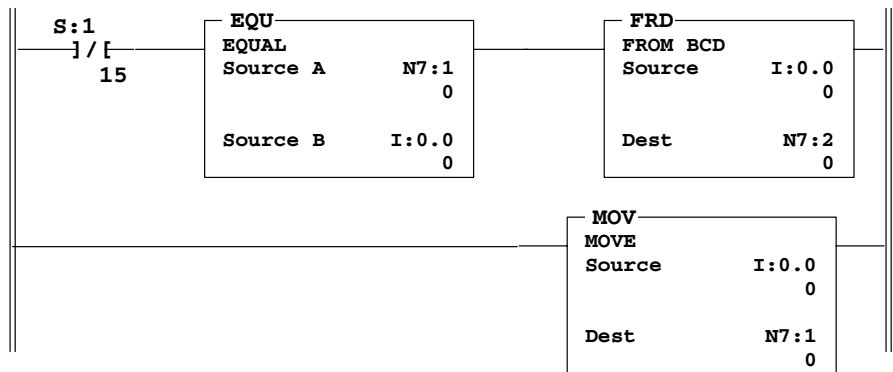

In the above example, the two rungs cause the processor to verify that the value at I:0.0 remains the same for two consecutive scans before it executes the FRD. This prevents the FRD from converting a non-BCD value during an input value change.

**TIP**

To convert numbers larger than 9999 BCD, the source must be the Math Register (S:13). You must reset the Minor Error bit (S:5/0) to prevent an error.

### Changes to the Math Register, S:13 and S:14

Used as the source for converting the entire number range of a register.

*Example 1*

The BCD value 9760 at source N7:3 is converted and stored in N10:0. The maximum source value is 9999, BCD.

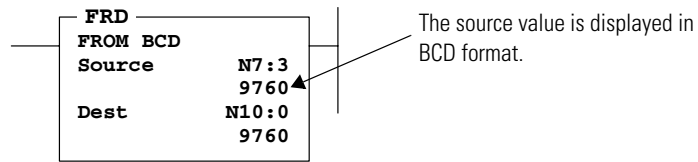

<b>9</b>	<b>7</b>	<b>6</b>	<b>0</b>	<b>N7:3</b>	<b>4-digit BCD</b>	1001	0111	0110	0000
↓	↓	↓	↓						
<b>9</b>	<b>7</b>	<b>6</b>	<b>0</b>	<b>N10:0</b>	<b>Decimal</b>	0010	0110	0010	0000

*Example 2*

The BCD value 32760 in the math register is converted and stored in N7:0.  
 The maximum source value is 32767, BCD.

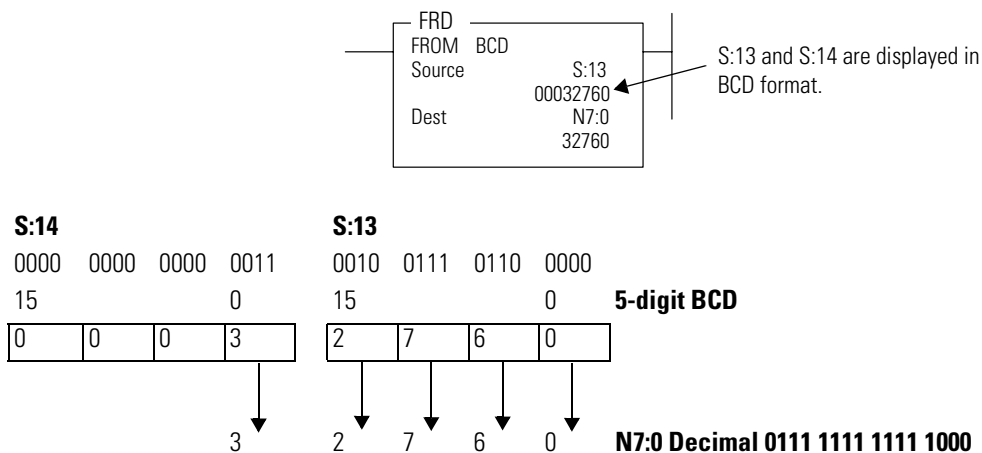

You should convert BCD values to integer before you manipulate them in your ladder program. If you do not convert the values, the processor manipulates them as integers and their value is lost.

**TIP**

If the math register (S:13 and S:14) is used as the source for the FRD instruction and the BCD value does not exceed 4 digits, be sure to clear word S:14 before executing the FRD instruction. If S:14 is not cleared and a value is contained in this word from another math instruction located elsewhere in the program, an incorrect decimal value will be placed in the destination word.

Clearing S:14 before executing the FRD instruction is shown.

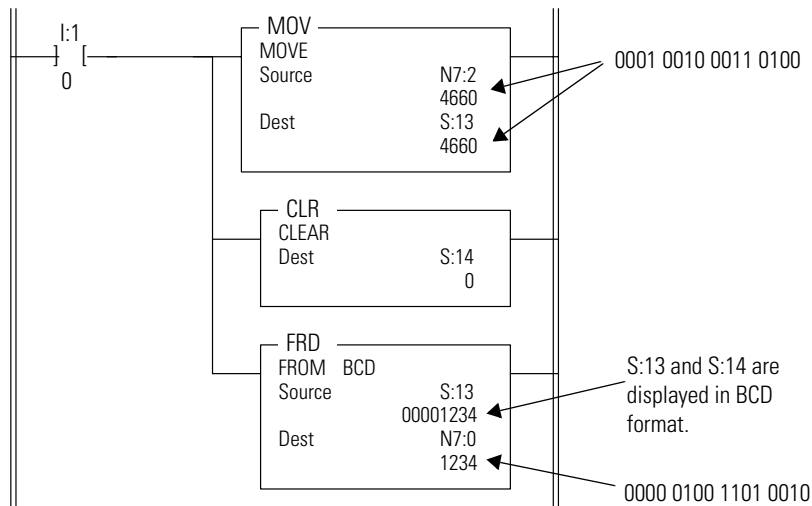

When the input condition is set (1), a BCD value (transferred from a 4-digit thumb wheel switch for example) is moved from word N7:2 into the math register. Status word S:14 is then cleared to make certain that unwanted data is not present when the FRD instruction is executed.

## Radian to Degrees (DEG)

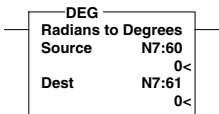

Use this instruction to convert radians (source) to degrees and store the result in the destination. The following formula applies:

$$\text{Source} * 180/\Pi$$

where  $\Pi = 3.141592$

Use this instruction with SLC 5/03 (OS302), SLC 5/04 (OS401), and SLC 5/05 processors.

Fixed	SLC 5/01	SLC 5/02	SLC 5/03	SLC 5/04	SLC 5/05
			•	•	•

Output Instruction

Example: Convert 3 radians to degrees. Using ratio where  $180^\circ = \Pi$  in radians, we have:

$$\frac{180}{\Pi} \rightarrow \frac{x}{3} = \frac{180}{\Pi} \rightarrow x = 3\left(\frac{180}{\Pi}\right) \rightarrow x = 171.89 \text{ degrees}$$

## Entering Parameters

- **Source** is the integer and/or floating point values.
- **Destination** is the address of the word where the data is to be stored.



## Updates to Arithmetic Status Bits

The arithmetic status bits are found in Word 0, bits 0 to 3 in the status file. After an instruction is executed, the arithmetic status bits in the status file are updated.

**Table 5.4 Processor Function**

With this Bit		The Processor
S:0/0	Carry (C)	always resets.
S:0/1	Overflow (V)	sets if overflow generated or an unsupported input is detected; otherwise resets
S:0/2	Zero (Z)	sets if the result is zero; otherwise resets
S:0/3	Sign (S)	sets if the result is negative; otherwise resets

## Degrees to Radians (RAD)

Use this instruction to convert degrees (source) to radians and store the result in the destination. The following formula applies.

$$\text{Source} * \Pi / 180$$

where  $\Pi = 3.141592$

Use this instruction with SLC 5/03 (OS302), SLC 5/04 (OS401), and SLC 5/05 processors.

Example: Convert 135 degrees to radians.

$$\frac{\Pi}{180} \rightarrow \frac{x}{135} = \frac{\Pi}{180} \rightarrow x = 135 \left( \frac{\Pi}{180} \right) \rightarrow x = 2.356 \text{ Radians}$$

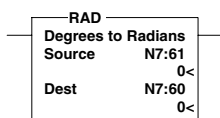

Fixed	SLC 5/01	SLC 5/02	SLC 5/03	SLC 5/04	SLC 5/05
			•	•	•

Output Instruction

## Entering Parameters

- **Source** is the integer and/or floating point values.
- **Destination** is the address of the word where the data is to be stored.

### Updates to Arithmetic Status Bits

The arithmetic status bits are found in Word 0, bits 0 to 3 in the status file. After an instruction is executed, the arithmetic status bits in the status file are updated.

**Table 5.5 Processor Function**

With this Bit		The Processor
S:0/0	Carry (C)	always resets.
S:0/1	Overflow (V)	sets if overflow generated or an unsupported input is detected; otherwise resets
S:0/2	Zero (Z)	sets if the result is zero; otherwise resets
S:0/3	Sign (S)	sets if the result is negative; otherwise resets

### Decode 4 to 1 of 16 (DCD)

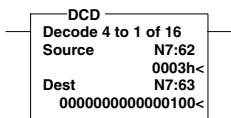

When executed, this instruction sets one bit of the destination word. The particular bit that is turned on depends on the value of the first four bits of the source word. See the table below.

Use this instruction to multiplex data in applications such as rotary switches, keypads, and bank switching.

Fixed	SLC 5/01	SLC 5/02	SLC 5/03	SLC 5/04	SLC 5/05
•	•	•	•	•	•

Output Instruction

Source					Destination																	
Bit	15-04	03	02	01	00	15	14	13	12	11	10	09	08	07	06	05	04	03	02	01	00	
x	0	0	0	0	0	0	0	0	0	0	0	0	0	0	0	0	0	0	0	0	0	1
x	0	0	0	0	1	0	0	0	0	0	0	0	0	0	0	0	0	0	0	0	1	0
x	0	0	1	0	0	0	0	0	0	0	0	0	0	0	0	0	0	0	1	0	0	0
x	0	0	1	1	0	0	0	0	0	0	0	0	0	0	0	0	0	1	0	0	0	0
x	0	1	0	0	0	0	0	0	0	0	0	0	0	0	0	1	0	0	0	0	0	0
x	0	1	0	1	0	0	0	0	0	0	0	0	0	0	1	0	0	0	0	0	0	0
x	0	1	1	0	0	0	0	0	0	0	0	0	0	0	0	0	0	0	0	0	0	0
x	0	1	1	1	0	0	0	0	0	0	0	0	0	0	1	0	0	0	0	0	0	0
x	1	0	0	0	0	0	0	0	0	0	0	0	1	0	0	0	0	0	0	0	0	0
x	1	0	0	1	0	0	0	0	0	0	1	0	0	0	0	0	0	0	0	0	0	0
x	1	0	1	0	0	0	0	0	0	1	0	0	0	0	0	0	0	0	0	0	0	0
x	1	0	1	1	0	0	0	0	0	1	0	0	0	0	0	0	0	0	0	0	0	0
x	1	1	0	0	0	0	0	0	1	0	0	0	0	0	0	0	0	0	0	0	0	0
x	1	1	0	1	0	0	0	0	0	0	0	0	0	0	0	0	0	0	0	0	0	0
x	1	1	1	0	0	0	0	0	0	0	0	0	0	0	0	0	0	0	0	0	0	0
x	1	1	1	1	0	0	0	0	0	0	0	0	0	0	0	0	0	0	0	0	0	0
x	1	1	1	1	1	1	1	1	1	1	1	1	1	1	1	1	1	1	1	1	1	1

## Entering Parameters

- Source is the address that contains the bit decode information. Only the first four bits (0 to 3) are used by the DCD instruction. The remaining bits may be used for other application specific needs. Change the value of the first four bits of this word to select one bit of the destination word.
- Destination is the address of the word where the data is to be stored.

### Updates to Arithmetic Status Bits

Unaffected.

## Encode 1 of 16 to 4 (ENC)

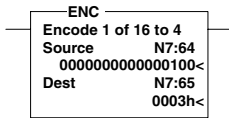

When the rung is true, this output instruction searches the source from the lowest to the highest bit, and looks for the first set bit. The corresponding bit position is written to the destination as an integer as shown in the table below.

Use this instruction to multiplex data in applications such as rotary switches, keypads, and bank switching.

Fixed	SLC 5/01	SLC 5/02	SLC 5/03	SLC 5/04	SLC 5/05
			•	•	•

Output Instruction

Source																Destination					
Bit	15	14	13	12	11	10	09	08	07	06	05	04	03	02	01	00	15 to 04	03	02	01	00
X	X	X	X	X	X	X	X	X	X	X	X	X	X	X	X	1	X	0	0	0	0
X	X	X	X	X	X	X	X	X	X	X	X	X	X	X	1	0	X	0	0	0	1
X	X	X	X	X	X	X	X	X	X	X	X	X	X	1	0	0	X	0	0	1	0
X	X	X	X	X	X	X	X	X	X	X	X	1	0	0	0	0	X	0	0	1	1
X	X	X	X	X	X	X	X	X	X	X	1	0	0	0	0	0	X	0	1	0	0
X	X	X	X	X	X	X	X	X	X	1	0	0	0	0	0	0	X	0	1	1	0
X	X	X	X	X	X	X	X	X	1	0	0	0	0	0	0	0	X	0	1	1	1
X	X	X	X	X	X	X	1	0	0	0	0	0	0	0	0	0	X	1	0	0	0
X	X	X	X	X	X	1	0	0	0	0	0	0	0	0	0	0	X	1	0	1	0
X	X	X	X	1	0	0	0	0	0	0	0	0	0	0	0	0	X	1	1	0	0
X	X	1	0	0	0	0	0	0	0	0	0	0	0	0	0	0	X	1	1	0	1
X	1	0	0	0	0	0	0	0	0	0	0	0	0	0	0	0	X	1	1	1	0
1	0	0	0	0	0	0	0	0	0	0	0	0	0	0	0	0	X	1	1	1	1

## Entering Parameters

- Source is the address of the word to be encoded. Only one bit of this word should be on at any time. If more than one bit in the source is set, the destination bits are set based on the least significant bit that is set. If a source of zero is used, all of the destination bits are reset and the arithmetic status zero bit (S:0/2) is set.
- Destination is the address that contains the bit encode information. Bits 4 to 15 of the destination are reset by the ENC instruction.

## Updates to Arithmetic Status Bits

The arithmetic status bits are found in Word 0, bits 0 to 3 in the status file. After an instruction is executed, the arithmetic status bits in the status file are updated.

**Table 5.6 Controller Function**

With this Bit		The Controller
S:0/0	Carry (C)	always resets.
S:0/1	Overflow (V)	sets if more than one bit in the source is set; otherwise reset. The math overflow bit (s:5/0) is <i>not</i> set.
S:0/2	Zero (Z)	sets if destination value zero.
S:0/3	Sign (S)	always resets.

## Copy File (COP) and Fill File (FLL) Instructions

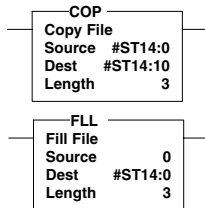

Fixed	SLC 5/01	SLC 5/02	SLC 5/03	SLC 5/04	SLC 5/05
•	•	•	•	•	•

Output Instruction

The destination file type determines the number of words that an instruction transfers. For example, if the destination file type is a counter and the source file type is an integer, three integer words are transferred for each element in the counter-type file.

After a COP or FLL instruction is executed, index register S:24 is cleared to zero.

### Using COP

This instruction copies blocks of data from one location into another. It uses no status bits. If you need an enable bit, program an output instruction (OTE) in parallel using an internal bit as the output address. The following figure shows how file instruction data is manipulated.

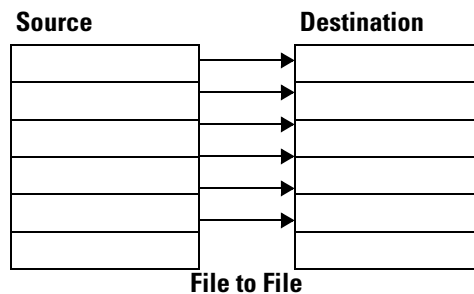

### Entering Parameters

Enter the following parameters when programming this instruction.

- Source is the address of the file you want to copy. You must use the file indicator (#) in the address.
- Destination is the starting address where the instruction stores the copy. You must use the file indicator (#) in the address.
- Length is the number of *elements* in the file you want to copy.
  - Maximum length is based on destination file type. If the destination file type is 3 words per element (Timer or Counter), you can specify a maximum length of 42. If the destination file type is 1 word per element, you can specify a maximum length of 128 words.

#### TIP

The maximum lengths are based on destination file type.

All elements are copied from the source file into the destination file each time the instruction is executed. Elements are copied in ascending order.

If your destination file type is a timer, counter, or control file, be sure that the source words corresponding to the status words of your destination file contains zeros.

Be sure that you accurately specify the starting address and length of the data block you are copying. The instruction will not write over a file boundary (such as between files N16 and N17) at the destination. An error occurs if a write is attempted over a file boundary.

You can perform file shifts by specifying a source element address one or more elements greater than the destination element address within the same file. This shifts data to lower element addresses.

## Using FLL

This instruction loads elements of a file with either a program constant or value from an element address.

The instruction fills the words of a file with a source value. It uses no status bits. If you need an enable bit, program a parallel output that uses a storage address. The following figure shows how file instruction data is manipulated.

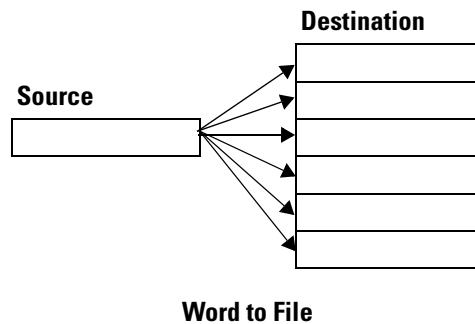

## Entering Parameters

Enter the following parameters when programming this instruction.

- Source is the program constant or element address. The file indicator (#) is not required for an element address. When using either an SLC 5/03 (OS301 or higher), SLC 5/04 (OS401), or SLC 5/05 processor, floating point and string values are supported.
- Destination is the destination starting address of the file you want to fill. You must use the file indicator (#) in the address. When using either an SLC 5/03 (OS301 or higher), SLC 5/04 (OS401), or SLC 5/05 processor, floating point and string values are supported.
- Length is the number of *elements* in the file you want filled.
  - Maximum length is based on destination file type. If the destination file type is 3 words per element (Timer or Counter), you can specify a maximum length of 42. If the destination file type is 1 word per element, you can specify a maximum length of 128 words.

**TIP**

The maximum lengths are based on destination file type.

**TIP**

All elements are filled from the source value (typically a constant) into the specified destination file each scan the rung is true. Elements are filled in ascending order.

The instruction will not write over a file boundary (such as between files N16 and N17) at the destination. An error is declared if a write is attempted over a file boundary.

## Move and Logical Instructions Overview

The following general information applies to move and logical instructions.

### Entering Parameters

- Source is the address of the value on which the logical or move operation is to be performed. The source can be a word address or a program constant, unless otherwise described. If the instruction has two source operands, it does not accept program constants in both operands.

When using either an SLC 5/03 (OS301 or higher), SLC 5/04 (OS401), or SLC 5/05 processor, floating point and string values are supported.

- Destination is the result address of a move or logical operation. It must be a word address.

### Using Indexed Word Addresses

You have the option of using indexed word addresses for instruction parameters specifying word addresses. Refer to Specifying Indexed Addresses on page E-10 for more information.

### Updates to Arithmetic Status Bits

The arithmetic status bits are found in Word 0, bits 0 to 3 in the controller status file. After an instruction is executed, the arithmetic status bits in the status file are updated.

### Using Indirect Word Addresses

You have the option of using indirect word-level and bit-level addresses for instructions specifying word addresses when using an SLC 5/03 (OS302), SLC 5/04 (OS401), or SLC 5/05 processors. Refer to Specifying an Indirect Address on page E-14 for more information.



## Updates to the Math Register, S:13 and S:14

Move and logical instructions do not affect the math register.

## Entering Mask Values

### TIP

When entering constants, you can use 'b' or 'h' to change the radix of your entry. For example, instead of entering -1 as a constant, you could enter 1111111111111111b or FFFFh.

## Move (MOV)

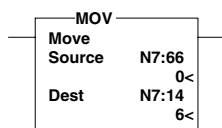

Fixed	SLC 5/01	SLC 5/02	SLC 5/03	SLC 5/04	SLC 5/05
•	•	•	•	•	•

Output Instruction

This output instruction moves the source value to the destination location. As long as the rung remains true, the instruction moves the data each scan.

## Entering Parameters

Enter the following parameters when programming this instruction.

- Source is the address or constant of the data you want to move
- Destination is the address where the instruction moves the data

### TIP

If you wish to move one word of data without affecting the arithmetic bits, use a copy (COP) instruction with a length of 1 word instead of the MOV instruction.

## Updates to Arithmetic Status Bits

The arithmetic status bits are found in Word 0, bits 0 to 3 in the controller status file. After an instruction is executed, the arithmetic status bits in the status file are updated.

**Table 5.7 Controller Function**

With this Bit		The Controller
S:0/0	Carry (C)	always resets.
S:0/1	Overflow (V)	always resets.
S:0/2	Zero (Z)	sets if result is zero; otherwise resets.
S:0/3	Sign (S)	sets if result is negative (most significant bit is set); otherwise resets.

## Masked Move (MVM)

The MVM instruction is a word instruction that moves data from a source location to a destination, and allows portions of the destination data to be masked by a separate word. As long as the rung remains true, the instruction moves the data each scan.

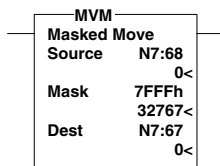

Fixed	SLC 5/01	SLC 5/02	SLC 5/03	SLC 5/04	SLC 5/05
•	•	•	•	•	•

Output Instruction

## Entering Parameters

Enter the following parameters when programming this instruction.

- **Source** is the address of the data you want to move
- **Mask** is the address of the mask through which the instruction moves data; the mask can also be a hexadecimal value (constant)
- **Destination** is the address where the instruction moves the data

## Updates to Arithmetic Status Bits

The arithmetic status bits are found in Word 0, bits 0 to 3 in the controller status file. After an instruction is executed, the arithmetic status bits in the status file are updated.

**Table 5.8 Controller Function**

With this Bit		The Controller
S:0/0	Carry (C)	always resets.
S:0/1	Overflow (V)	always resets.
S:0/2	Zero (Z)	sets if result is zero; otherwise resets.
S:0/3	Sign (S)	sets if result is negative; otherwise resets.

*Operation*

When the rung containing this instruction is true, data at the source address passes through the mask to the destination address. See the figure below.

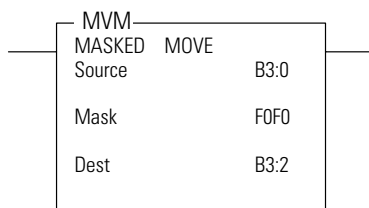

B3:2 before move

1 1 1 1 1 1 1 1 1 1 1 1 1 1 1 1

source B3:0

0 1 0 1 0 1 0 1 0 1 0 1 0 1 0 1

Mask F0F0

1 1 1 1 0 0 0 0 1 1 1 1 0 0 0 0

B3:2 after move

0 1 0 1 1 1 1 1 0 1 0 1 1 1 1 1

Mask data by resetting bits in the mask; pass data by setting bits in the mask to one. The bits of the mask can be fixed by a constant value, or you can vary them by assigning the mask a direct address.

**TIP**

Bits in the destination that correspond to zeros in the mask are not altered.

## And (AND)

This instruction performs a bit-by-bit logical AND. The operation is performed using the value at source A and the value at source B. The result is stored in the destination.

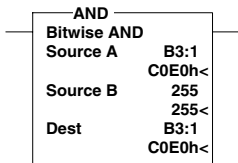

Fixed	SLC 5/01	SLC 5/02	SLC 5/03	SLC 5/04	SLC 5/05
•	•	•	•	•	•

Output Instruction

**Table 5.9 Truth Table for A AND B = Dest**

A	B	Dest
0	0	0
1	0	0
0	1	0
1	1	1

Source A and B can either be a word address or a constant; however, both sources cannot be a constant. The destination must be a word address.

## Updates to Arithmetic Status Bits

The arithmetic status bits are found in Word 0, bits 0 to 3 in the controller status file. After an instruction is executed, the arithmetic status bits in the status file are updated.

**Table 5.10 Controller Function**

With this Bit		The Controller
S:0/0	Carry (C)	always resets.
S:0/1	Overflow (V)	always resets.
S:0/2	Zero (Z)	sets if result is zero; otherwise resets.
S:0/3	Sign (S)	sets if most significant bit is set; otherwise resets.

## Or (OR)

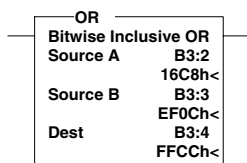

Fixed	SLC 5/01	SLC 5/02	SLC 5/03	SLC 5/04	SLC 5/05
•	•	•	•	•	•

Output Instruction

This instruction performs a bit-by-bit logical OR. The operation is performed using the value at source A and the value at source B. The result is stored in the destination.

**Table 5.11 Truth Table for A OR B = Dest**

A	B	Dest
0	0	0
1	0	1
0	1	1
1	1	1

Source A and B can either be a word address or a constant; however, both sources cannot be a constant. The destination must be a word address.

## Updates to Arithmetic Status Bits

The arithmetic status bits are found in Word 0, bits 0 to 3 in the controller status file. After an instruction is executed, the arithmetic status bits in the status file are updated.

**Table 5.12 Controller Function**

With this Bit		The Controller
S:0/0	Carry (C)	always resets.
S:0/1	Overflow (V)	always resets.
S:0/2	Zero (Z)	sets if result is zero; otherwise resets.
S:0/3	Sign (S)	sets if result is negative (most significant bit is set) otherwise resets.

## Exclusive Or (XOR)

This instruction performs a bit-by-bit logical XOR. The operation is performed using the value at source A and the value at source B. The result is stored in the destination.

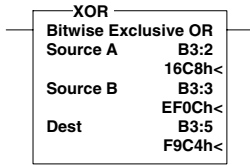

Fixed	SLC 5/01	SLC 5/02	SLC 5/03	SLC 5/04	SLC 5/05
•	•	•	•	•	•

Output Instruction

**Table 5.13 Truth Table for A XOR B = Dest**

A	B	Dest
0	0	0
1	0	1
0	1	1
1	1	0

Source A and B can either be a word address or a constant; however, both sources cannot be a constant. The destination must be a word address.

## Updates to Arithmetic Status Bits

The arithmetic status bits are found in Word 0, bits 0 to 3 in the controller status file. After an instruction is executed, the arithmetic status bits in the status file are updated.

**Table 5.14 Controller Function**

With this Bit		The Controller
S:0/0	Carry (C)	always resets.
S:0/1	Overflow (V)	always resets.
S:0/2	Zero (Z)	sets if result is zero; otherwise resets
S:0/3	Sign (S)	sets if result is negative (most significant bit is set); otherwise resets.

## Not (NOT)

This instruction performs a bit-by-bit logical NOT. The operation is performed using the value at source A. The result (one's complement of A) is stored in the destination.

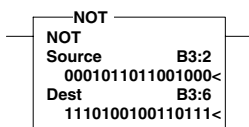

Fixed	SLC 5/01	SLC 5/02	SLC 5/03	SLC 5/04	SLC 5/05
•	•	•	•	•	•

Output Instruction

**Table 5.15 Truth Table for A Not = Dest**

A	Dest
0	1
1	0

The source and destination must be word addresses.

## Updates to Arithmetic Status Bits

The arithmetic status bits are found in Word 0, bits 0 to 3 in the controller status file. After an instruction is executed, the arithmetic status bits in the status file are updated.

**Table 5.16 Controller Function**

With this Bit		The Controller
S:0/0	Carry (C)	always resets.
S:0/1	Overflow (V)	always resets.
S:0/2	Zero (Z)	sets if result is zero; otherwise resets.
S:0/3	Sign (S)	sets if result is negative (most significant bit is set); otherwise resets.

## Negate (NEG)

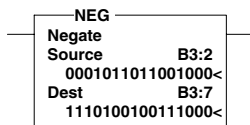

Use the NEG instruction to change the sign of the source and then place it in the destination. The destination contains the two's complement of the source. For example, if the source is 5, the destination would be -5.

The source and destination must be word addresses.

## Updates to Arithmetic Status Bits

The arithmetic status bits are found in Word 0, bits 0 to 3 in the controller status file. After an instruction is executed, the arithmetic status bits in the status file are updated.

Fixed	SLC 5/01	SLC 5/02	SLC 5/03	SLC 5/04	SLC 5/05
•	•	•	•	•	•

Output Instruction

**Table 5.17 Controller Function**

With this Bit		The Controller
S:0/0	Carry (C)	clears if 0 or overflow, otherwise sets.
S:0/1	Overflow (V)	sets if overflow, otherwise reset. Overflow occurs only if -32,768 is the source. On overflow, the minor error flag is also set. The value 32,767 is placed in the destination. If S:2/14 is set, then the unsigned, truncated overflow remains in the destination. For floating point destinations, the overflow result remains in the destination.
S:0/2	Zero (Z)	sets if result is zero; otherwise resets.
S:0/3	Sign (S)	sets if result is negative; otherwise resets.



## FIFO and LIFO Instructions Overview

FIFO (First in First out) instructions load words into a file and unload them in the same order as they were loaded. The first word in is the first word out.

LIFO (Last in First out) instructions load words into a file and unload them in the opposite order as they were loaded. The last word in is the first word out.

### Entering Parameters

Enter the following parameters when programming these instructions.

- **Source** is a word address or constant (-32,768 to 32,767) that becomes the next value in the stack
- **Destination** is a word address that stores the value that exits from the stack

**Table 5.18 Instruction Function**

This Instruction	Unloads the Value from
FIFO's FFU	First word
LIFO's LFU	The last word entered

- **FIFO/LIFO** is the address of the stack. It must be an indexed word address in the bit, input, output, or integer file.
- **Length** specifies the maximum number of words in the stack. This is 128 words. Address the length value by mnemonic (LEN).
- **Position** is the next available location where the instruction loads data into the stack. This value changes after each load or unload operation. Address the position value by mnemonic (POS).
- **Control** is a control file address. The status bits, the stack length, and the position value are stored in this element. Use the same control file address for the associated FFL and FFU instructions; use the same control file address for the associated LFL and LFU instructions. Do not use the control file address for any other instruction.

Status bits of the control structure are addressed by mnemonic. These include:

- Empty Bit EM (bit 12) is set by the processor to indicate the stack is empty.
- Done Bit DN (bit 13) is set by the processor to indicate the stack is full. This inhibits loading the stack.
- FFU/LFU Enable Bit EU (bit 14) is set on a false-to-true transition of the FFU/LFU rung and is reset on a true-to-false transition.
- FFL/LFL Enable Bit EN (bit 15) is set on a false-to-true transition of the FFL/LFL rung and is reset on a true-to-false transition.

### Effects on Index Register S:24

The value present in S:24 is overwritten with the position value when a false-to-true transition of the FFL/FFU or LFL/LFU rung occurs. For the FFL/LFL, the position value determined at instruction entry is placed in S:24. For the FFU/LFU, the position value determined at instruction exit is placed in S:24.

When the DN bit is set, a false-to-true transition of the FFL/LFL rung does not change the position value or the index register value. When the EM bit is set, a false-to-true transition of the FFU/LFU rung does not change the position value or the index register value.

### FIFO Load (FFL) and FIFO Unload (FFU)

FFL and FFU instructions are used in pairs. The FFL instruction loads words into a user-created file called a FIFO stack. The FFU instruction unloads words from the FIFO stack, in the same order as they were entered.

Instruction parameters have been programmed in the FFL-FFU instruction pair shown on page 5-27.

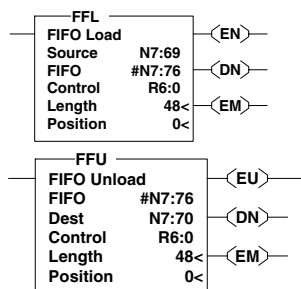

Fixed	SLC 5/01	SLC 5/02	SLC 5/03	SLC 5/04	SLC 5/05
		•	•	•	•

Output Instructions

**Table 5.19 Instruction Function**

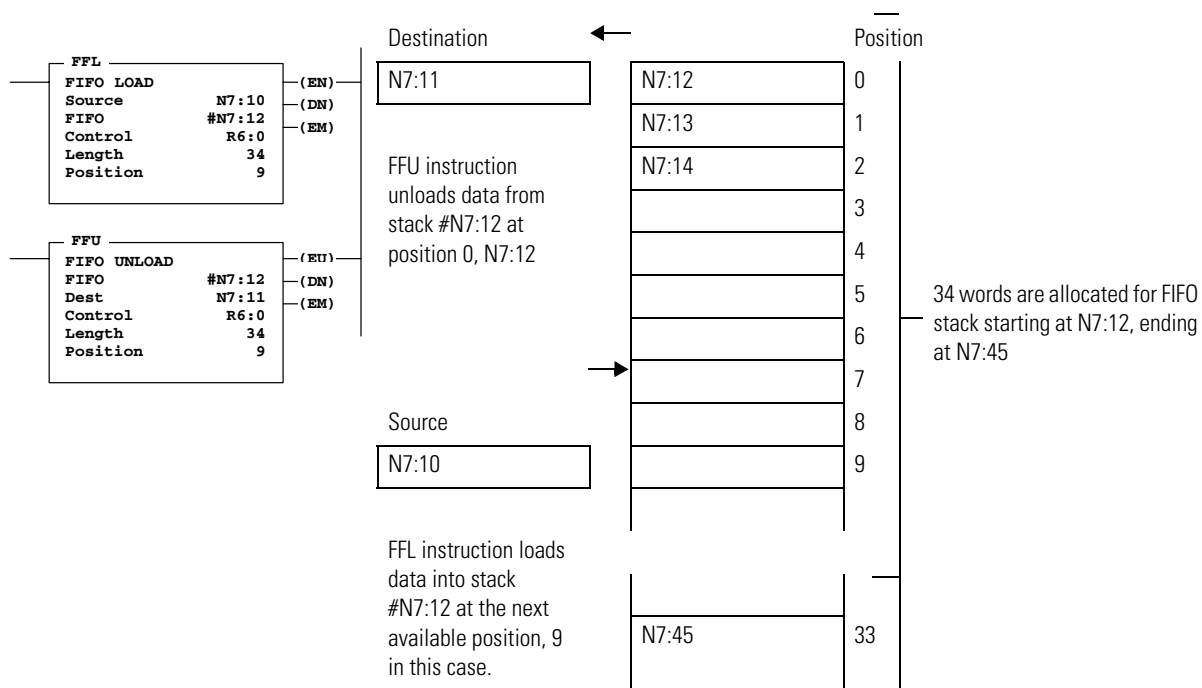

### FFL Instruction Operation

When rung conditions change from false-to-true, the FFL enable bit (EN) is set. This loads the contents of the source, N7:10, into the stack element indicated by the position number, 9. The position value then increments.

The FFL instruction loads an element at each false-to-true transition of the rung, until the stack is filled (34 elements). The processor then sets the done bit (DN), inhibiting further loading.

### FFU Instruction Operation

When rung conditions change from false-to-true, the FFU enable bit (EU) is set. This unloads the contents of the element at stack position 0 into the destination, N7:11. All data in the stack is shifted one element toward position zero, and the highest numbered element is zeroed. The position value then decrements.

The FFU instruction unloads an element at each false-to-true transition of the rung, until the stack is empty. The processor then sets the empty bit (EM).

## LIFO Load (LFL) and LIFO Unload (LFU)

LFL and LFU instructions are used in pairs. The LFL instruction loads words into a user-created file called a LIFO stack. The LFU instruction unloads words from the LIFO stack in the opposite order as they were entered.

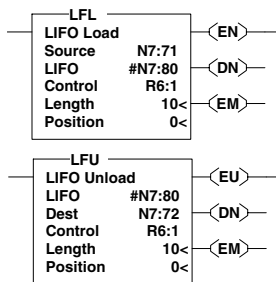

Instruction parameters have been programmed in the LFL - LFU instruction pair shown below.

Fixed	SLC 5/01	SLC 5/02	SLC 5/03	SLC 5/04	SLC 5/05
		•	•	•	•

Output Instruction

**Table 5.20 Instruction Function**

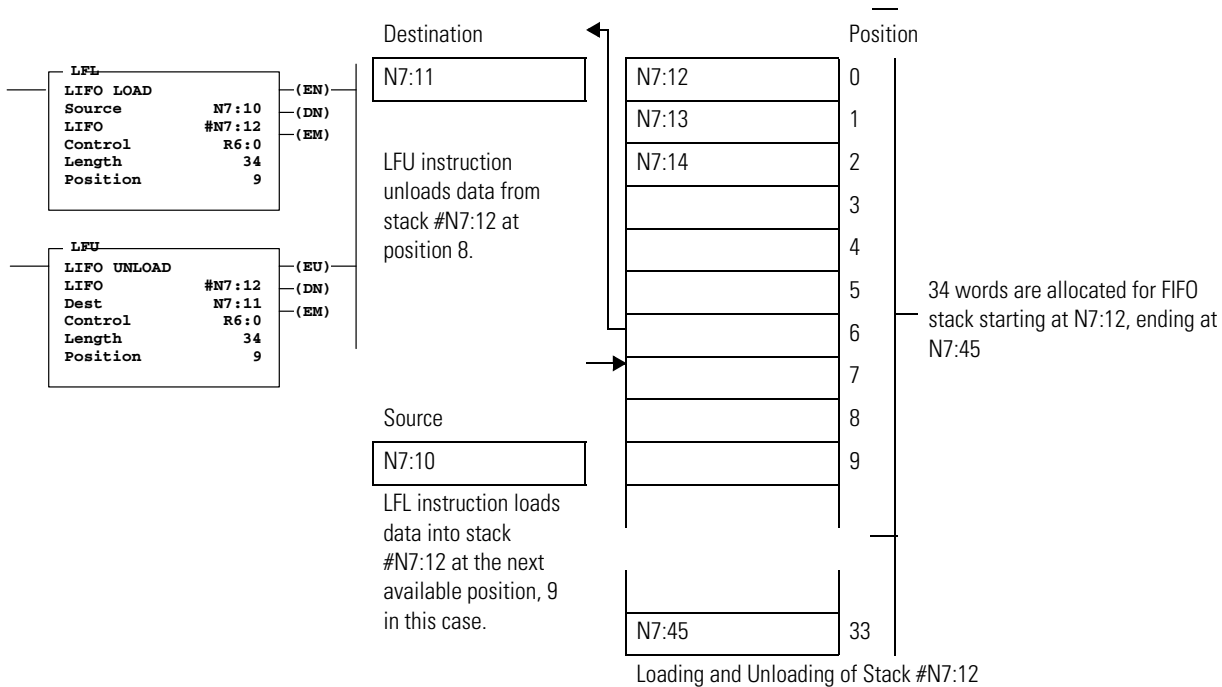

## LFL Instruction Operation

When rung conditions change from false-to-true, the LFL enable bit (EN) is set. This loads the contents of the source, N7:10, into the stack element indicated by the position number, 9. The position value then increments.

The LFL instruction loads an element at each false-to-true transition of the rung, until the stack is filled (34 elements). The processor then sets the done bit (DN), inhibiting further loading.

## LFU Instruction Operation

When rung conditions change from false-to-true, the LFU enable bit (EU) is set. This unloads data from the last element loaded into the stack (at the position value minus 1), placing it in the destination, N7:11. The position value then decrements.

The LFU instruction unloads one element at each false-to-true transition of the rung, until the stack is empty. The processor then sets the empty bit (EM).

**Notes:**

## Program Flow Instructions

This chapter contains general information about the program flow instructions and explains how they function in your application program. Each of the instructions includes information on:

- what the instruction symbol looks like.
- how to use the instruction.

**Table 6.1 Program Flow Instructions**

Instruction Mnemonic	Instruction Name	Purpose	Page
<b>JMP and LBL</b>	Jump to Label and Label	Jump forward or backward to the specified label instruction.	6-2
<b>JSR, SBR, and RET</b>	Jump to Subroutine, Subroutine, and Return from Subroutine	Jump to a designated subroutine and return.	6-3
<b>MCR</b>	Master Control Reset	Turn off all non-retentive outputs in a section of ladder program.	6-6
<b>TND</b>	Temporary End	Mark a temporary end that halts program execution.	6-7
<b>SUS</b>	Suspend	Identifies specific conditions for program debugging and system troubleshooting.	6-8
<b>IIM</b>	Immediate Input with Mask	Program an Immediate Input with Mask.	6-8
<b>IOM</b>	Immediate Output with Mask	Program an Immediate Output with Mask.	6-9
<b>REF</b>	Refresh	Interrupt the program scan to execute the I/O scan and service communications.	6-10

### About the Program Flow Control Instructions

Use these instructions to control the sequence in which your program is executed.

Control instructions allow you to change the order in which the processor scans a ladder program. Typically, these instructions are used to minimize scan time, create a more efficient program, and troubleshoot a ladder program.

## Jump to Label (JMP) and Label (LBL)

—(JMP)—

—]LBL[—

Fixed	SLC 5/01	SLC 5/02	SLC 5/03	SLC 5/04	SLC 5/05
•	•	•	•	•	•

Use these instructions in pairs to skip portions of the ladder program.

**Table 6.2 Program Function**

If the Rung Containing the Jump Instruction is	Then the Program
True	Skips from the rung containing the JMP instruction to the rung containing the designated LBL instruction and continues executing. You can jump forward or backward.
False	Does not execute the JMP instruction.

Jumping forward to a label saves program scan time by omitting a program segment until needed. Jumping backward lets the controller execute program segments repeatedly.

**TIP**

Be careful not to jump backwards an excessive number of times. The watchdog timer could time out and fault the controller. Use a counter, timer, or the program scan register (system status register, word S:3, bits 0 to 7) to limit the amount of time you spend looping inside of JMP/LBL instructions.

### Entering Parameters

Enter a decimal label number from 0 to 255 in each subroutine file.

### Using JMP

The JMP instruction causes the controller to skip rungs. You can jump to the same label from one or more JMP instructions.



## Using LBL

This input instruction is the target of JMP instructions having the same label number. You must program this instruction as the first instruction of a rung. This instruction has no control bits.

You can program multiple jumps to the same label by assigning the same label number to multiple JMP instructions. However, label numbers must be unique.

**TIP** Do not jump (JMP) into an MCR zone. Instructions that are programmed within the MCR zone starting at the LBL instruction and ending at the END MCR instruction are always evaluated as though the MCR zone is true, regardless of the true state of the Start MCR instruction.

## Jump to Subroutine (JSR), Subroutine (SBR), and Return (RET)

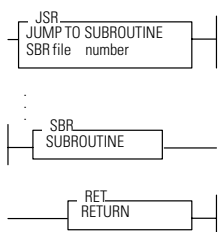

The JSR, SBR, and RET instructions are used to direct the controller to execute a separate subroutine file within the ladder program and return to the instruction following the JSR instruction.

**TIP** If you use the SBR instruction, the SBR instruction must be the first instruction on the first rung in the program file that contains the subroutine.

Fixed	SLC 5/01	SLC 5/02	SLC 5/03	SLC 5/04	SLC 5/05
•	•	•	•	•	•

Use a subroutine to store recurring sections of program logic that must be executed from several points within your application program. A subroutine saves memory because you program it only once.

Update critical I/O within subroutines using immediate input and/or output instructions (IIM, IOM), especially if your application calls for nested or relatively long subroutines. Otherwise, the controller does not update I/O until it reaches the end of the main program (after executing all subroutines).

**ATTENTION** Outputs controlled within a subroutine remain in their last state until the subroutine is executed again.



## Nesting Subroutine Files

Nesting subroutines allows you to direct program flow from the main program to a subroutine and then on to another subroutine. The following rules apply when nesting subroutines.

- With Fixed and SLC 5/01 processors, you can nest subroutines up to four levels
- With SLC 5/02 and higher processors, you can nest subroutines up to eight levels. If you are using an STI subroutine, DII subroutine, I/O event-driven interrupt subroutine, or user fault routine, you can nest subroutines up to three levels from each subroutine.

The following figure illustrates how subroutines may be nested.

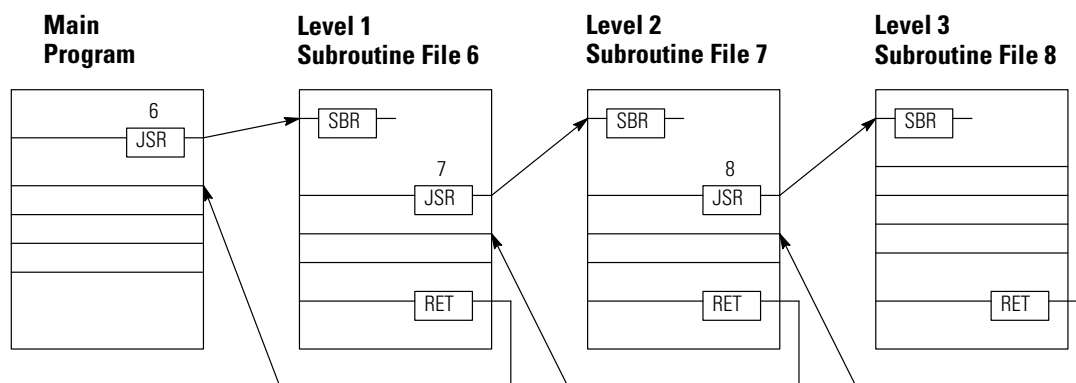

An error occurs if more than the allowable levels of subroutines are called (subroutine stack overflow) or if more returns are executed than there are call levels (subroutine stack underflow).

## Using JSR

When the JSR instruction is executed, the controller jumps to the subroutine instruction (SBR) at the beginning of the target subroutine file and resumes execution at that point. You cannot jump into any part of a subroutine except the first instruction in that file.

You must program each subroutine in its own program file by assigning a unique file number (3 to 255)

**IMPORTANT**

*Fixed and SLC 5/01 specific* - The JSR instruction cannot be programmed in nested output branches. A compiler error will occur if a rung containing multiple outputs with conditional logic and a JSR instruction is encountered.

## Using SBR

The target subroutine is identified by the file number that you entered in the JSR instruction. This instruction serves as a label or identifier for a program file as a regular subroutine file.

This instruction has no control bits. It is always evaluated as true. The instruction must be programmed as the first instruction of the first rung of a subroutine. Use of this instruction is optional; however, we recommend using it for clarity.

## Using RET

This output instruction marks the end of subroutine execution or the end of the subroutine file. It causes the controller to resume execution at the instruction following the JSR instruction. If a sequence of nested subroutines is involved, the instruction causes the processor to return program execution to the previous subroutine.

The rung containing the RET instruction may be conditional if this rung precedes the end of the subroutine. In this way, the controller omits the balance of a subroutine only if its rung condition is true.

Without an RET instruction, the END instruction (always present in the subroutine) automatically returns program execution to the instruction following the JSR instruction in your calling ladder file.

**TIP**

The RET instruction terminates execution of the DII subroutine (SLC 5/03 and higher processors), STI subroutine, I/O event-driven interrupt subroutine, and the user fault routine (SLC 5/02 or higher processor).

## Master Control Reset (MCR)

Use MCR instructions in pairs to create program zones that turn off all the non-retentive outputs in the zone. Rungs within the MCR zone are still scanned, but scan time is reduced due to the false state of non-retentive outputs.

—(MCR)—

Fixed	SLC 5/01	SLC 5/02	SLC 5/03	SLC 5/04	SLC 5/05
•	•	•	•	•	•

**Table 6.3 Controller Function**

If the MCR Rung that Starts the Zone is	Then the Controller
True	Executes the rungs in the MCR zone based on each rung's individual input condition (as if the zone did not exist).
False	Resets all non-retentive output instructions in the MCR zone regardless of each rung's individual input conditions.

MCR zones let you enable or inhibit segments of your program, such as for recipe applications.

When you program MCR instructions, note that:

- you must end the zone with an unconditional MCR instruction.
- you cannot nest one MCR zone within another.
- do not jump into an MCR zone. If the zone is false, jumping into it activates the zone.
- always place the MCR instruction as the last instruction in a rung.

## Processor Operation

Do not jump (JMP) into an MCR zone. Instructions that are programmed within the MCR zone starting at the LBL instruction and ending at the END MCR instruction are always evaluated as though the MCR zone is true, regardless of the true state of the Start MCR instruction. If the zone is false, jumping into it activates the zone from the LBL to the end of the zone.

**ATTENTION**



If you start instructions such as timers or counters in an MCR zone, instruction operation ceases when the zone is disabled. Re-program critical operations outside the zone if necessary.

The TOF timer activates when placed inside of a false MCR zone.

The MCR instruction is not a substitute for a hard-wired master control relay. We recommend that your programmable controller system include a hard-wired master control relay and emergency stop switches to provide I/O power shut down.

Emergency stop switches can be monitored but should not be controlled by the ladder program. Wire these devices as described in the installation manual.

SLC 5/03 and higher processors - When online and an unmatched MCR instruction exists in your program, the END instruction acts as the second unconditional MCR instruction and all of the rungs following the first MCR instruction execute via the current MCR instruction state.

You can save the program while online if unmatched MCR instructions exist. However, if you are offline and unmatched MCR instructions exist, an error will occur.

## Temporary End (TND)

This instruction, when its rung is true, stops the processor from scanning the rest of the program file, updates the I/O, and resumes scanning at rung 0 of the main program (file 2). If this instruction's rung is false, the processor continues the scan until the next TND instruction or the END statement. Use this instruction to progressively debug a program, or conditionally omit the balance of your current program file or subroutines.

—(TND)—

Fixed	SLC 5/01	SLC 5/02	SLC 5/03	SLC 5/04	SLC 5/05
•	•	•	•	•	•

Output Instruction

**TIP**

If you use this instruction inside a nested subroutine, execution of all nested subroutines is terminated.

## Suspend (SUS)

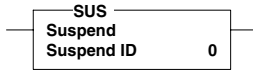

Fixed	SLC 5/01	SLC 5/02	SLC 5/03	SLC 5/04	SLC 5/05
•	•	•	•	•	•

Output Instruction

When this instruction is executed, it causes the processor to enter the Suspend Idle mode and stores the Suspend ID in word 7 (S:7) of the status file. All outputs are de-energized.

Use this instruction to trap and identify specific conditions for program debugging and system troubleshooting.

### Entering Parameters

Enter a suspend ID number from -32,768 to +32,767 when you program the instruction.

When the SUS instruction is executed, the programmed suspend ID, S:7 (word 7), as well as the program file ID, S:8 (word 8), from which the SUS instruction executed is placed in the system status file.

## Immediate Input with Mask (IIM)

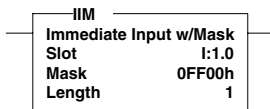

Fixed	SLC 5/01	SLC 5/02	SLC 5/03	SLC 5/04	SLC 5/05
•	•	•	•	•	•

Input Instruction

This instruction allows you to update data prior to the normal input scan. When the IIM instruction is enabled, the program scan is interrupted. Data from a specified I/O slot is transferred through a mask to the input data file, making the data available to instructions following the IIM instruction in the ladder program.

### Entering Parameters

**Slot** - Specify the input slot number and the word number pertaining to the slot. Word 0 of a slot need not be specified. Fixed and SLC 5/01 processors can have up to 8 words associated with the slot. The SLC 5/02 and higher processors can have up to 32 words associated with the slot (0 to 31).

For 16 I/O controllers, O:0/0 to 5 are valid and O:0/6 to 15 are considered unused outputs. (They do not physically exist). For 32 I/O controllers, O:0/0 to 11 are valid and O:0/12 to 15 are considered unused outputs.

#### Example

I:2	Inputs of slot 2, word 0
I:2.1	Inputs of slot 2, word 1
I:1	Inputs of slot 1, word 0

**Mask** - Specify a hexadecimal constant or register address.

For the mask, a 1 in an input's bit position passes data from the source (physical input) to the destination (input image table). A 0 inhibits data from passing from the source to the destination.

Refer to Entering Mask Values on page 5-17 for information about entering mask.

**Length** - For SLC 5/03 and higher processors, this parameter is used to transfer more than one word per slot. Valid value is from 1 to 32.

## Immediate Output with Mask (IOM)

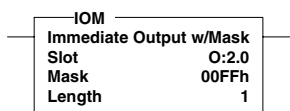

Fixed	SLC 5/01	SLC 5/02	SLC 5/03	SLC 5/04	SLC 5/05
•	•	•	•	•	•

Output Instruction

This instruction allows you to update the outputs prior to the normal output scan. When the IOM instruction is enabled, the program scan is interrupted to transfer data to a specified I/O slot through a mask. The program scan then resumes.

### Entering Parameters

**Slot** - Specify the slot number and the word number pertaining to the slot. Word 0 of a slot need not be specified. Fixed and SLC 5/01 processors can have up to 8 words associated with the slot. The SLC 5/02 and higher processors can have up to 32 words associated with the slot (0 to 30).

For 16 I/O controllers, O:0/0 to 5 are valid and O:0/6 to 15 are considered unused outputs. (They do not physically exist). For 32 I/O controllers, O:0/0 to 11 are valid and O:0/12 to 15 are considered unused outputs.

#### Example

O:2	Outputs of slot 2, word 0
O:1	Outputs of slot 1, word 0
O:2.1	Outputs of slot 2, word 1

**Mask** - Specify a hexadecimal constant or register address.

For the mask, a 1 in the output bit position passes data from the source (output image table) to the destination (physical output). A 0 inhibits the data from passing from the source to the destination.

Refer to Entering Mask Values on page 5-17 for information about entering mask.

**Length** - For SLC 5/03 and higher processors, this parameter is used to transfer more than one word per slot. Valid value is from 1 to 32.

## I/O Refresh (REF)

—(REF)—  
SLC 5/02 Processor

Fixed	SLC 5/01	SLC 5/02	SLC 5/03	SLC 5/04	SLC 5/05
		•	•	•	•

Output Instruction

## Using an SLC 5/02 Processor

The REF instruction has no programming parameters. When it is evaluated as true, the program scan is interrupted to execute the I/O scan and service communication portions of the operating cycle (write outputs, service comms, read inputs). The scan then resumes at the instruction following the REF instruction.

You are not allowed to place a REF instruction in an STI subroutine, I/O subroutine, or user fault subroutine.

### ATTENTION



The watchdog and scan timers are reset when executing the REF instruction. You must insure that an REF instruction is not placed inside a non-terminating program loop. Do not place an REF instruction inside a program loop unless the program is thoroughly analyzed.

## Using SLC 5/03 and Higher Processors

Operation of the REF instruction in the SLC 5/03 and higher processors is the same as the SLC 5/02 processor. However, when using the SLC 5/03 and higher processors, you can also select a specific communication channel to be serviced.

REF	
Refresh I/O	Yes
Channel 0	Yes
Channel 1	No

- SLC 5/03 processor.
  - channel 0 is RS-232/DF1 Full-duplex, DF1 Half-duplex (master or slave), DF1 Radio Modem, DH-485, or ASCII
  - channel 1 is DH-485
- SLC 5/04 processor.
  - channel 0 is RS-232/DF1 Full-duplex, DF1 Half-duplex (master or slave), DF1 Radio Modem, DH-485, or ASCII
  - channel 1 is DH+
- SLC 5/05 processor.
  - channel 0 is RS-232/DF1 Full-duplex, DF1 Half-duplex (master or slave), DF1 Radio Modem, DH-485, or ASCII
  - channel 1 is Ethernet

You are not allowed to place a REF instruction in a DII subroutine, STI subroutine, I/O subroutine, or user fault subroutine.



## Application Specific Instructions

This chapter contains general information about the application specific instructions and explains how they function in your application program. Each of the instructions includes information on:

- what the instruction symbol looks like.
- how to use the instruction.

**Table 7.1 Application Specific Instructions**

Instruction Mnemonic	Instruction Name	Purpose	Page
<b>BSL and BSR</b>	Bit Shift Left and Bit Shift Right	Loads a bit of data into a bit array, shifts the pattern of data through the array, and unloads the last bit of data in the array. The BSL shifts data to the left and the BSR shifts data to the right.	7-4
<b>SQO and SQC</b>	Sequencer Output and Sequencer Compare	Controls sequential machine operations by transferring 16-bit data through a mask to image addresses.	7-6
<b>SQL</b>	Sequencer Load	Captures referenced conditions by manually stepping the machine through its operating sequences.	7-12
<b>RHC</b>	Read High Speed Clock	Provides a high performance time-stamp for performance diagnostics and performing calculations such as velocity.	7-17
<b>TDF</b>	Compute Time Difference	Calculates the number of 10 $\mu$ s "ticks" between any two time-stamps captured using the RHC instruction.	7-17
<b>FBC</b>	File Bit Comparison	Used to monitor machine or process operations to detect malfunctions.	7-18
<b>DDT</b>	Diagnostic Detect		7-18
<b>RPC</b>	Read Program Checksum	Copies the program checksum from processor memory or from the memory module into the data table.	7-23

## About the Application Specific Instructions

These instructions simplify your ladder program by allowing you to use a single instruction or pair of instructions to perform common complex operations.

In this chapter you will find a general overview preceding groups of instructions. Before you learn about the instructions in each of these groups, we suggest that you read the overview that precedes each section. This chapter contains the following overviews.

- Bit Shift Instructions Overview
- Sequencer Instructions Overview
- RHC/TDF Instructions Overview

## Bit Shift Instructions Overview

The following general information applies to bit shift instructions.

### Entering Parameters

Enter the following parameters when programming these instructions.

- **File** is the address of the bit array you want to manipulate. You must use the file indicator (#) in the bit array address.
- **Control** is the control element that stores the status byte of the instruction and the size of the array (in number of bits). Note that the control address should not be used for any other instruction.

**Table 7.2 Control File Structure**

	15	14	13	12	11	10	09	08	07	06	05	04	03	02	01	00
Word 0	EN		DN		ER	UL			Not Used							
Word 1	Size of bit array (number of bits)															
Word 2	Reserved															

Status bits of the control element may be addressed by mnemonic. They include:

- Unload Bit UL (bit 10) stores the status of the bit exited from the array each time the instruction is enabled.
- Error Bit ER (bit 11), when set, indicates the instruction detected an error such as entering a negative number for the length or position. Avoid using the output bit when this bit is set.
- Done Bit DN (bit 13), when set, indicates the bit array has shifted one position.
- Enable Bit EN (bit 15) is set on a false-to-true transition of the rung and indicates the instruction is enabled.

When the register shifts and input conditions go false, the enable, done, and error bits are reset.

- **Bit Address** is the address of the source bit that the instruction inserts in the first (lowest) bit position (BSL) or the last (highest) bit position (BSR).
- **Length** (size of bit array) is the number of bits in the bit array, up to 2048 bits. A length value of 0 causes the input bit to be transferred to the UL bit.

A length value that points past the end of the programmed file causes a runtime major error to occur.

**TIP**

If you alter a length value with your ladder program, make certain that the altered value is valid.

The instruction invalidates all bits beyond the last bit in the array (as defined by the length) up to the next word boundary

**TIP**

If a String element address is used for the file parameter, the maximum length for SLC 5/03 and higher processors is 672 bits. Additionally, String element boundaries cannot be crossed.

## Effects on Index Register S:24

The shift operation clears the index register S:24 to zero.

## Bit Shift Left (BSL) Bit Shift Right (BSR)

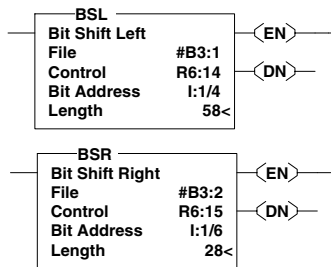

Fixed	SLC 5/01	SLC 5/02	SLC 5/03	SLC 5/04	SLC 5/05
•	•	•	•	•	•

Output Instructions

BSL and BSR are output instructions that load data into a bit array one bit at a time. The data is shifted through the array, then unloaded one bit at a time.

### Use BSL

When the rung goes from false-to-true, the processor sets the enable bit (EN bit 15) and the data block is shifted to the left (to a higher bit number) one bit position. The specified bit at the bit address is shifted into the first bit position. The last bit is shifted out of the array and stored in the unload bit (UL bit 10). The shift is completed immediately.

For wraparound operation, set the position of the bit address to the last bit of the array or to the UL bit, whichever applies.

The figure below illustrates how the Bit Shift Left instruction works.

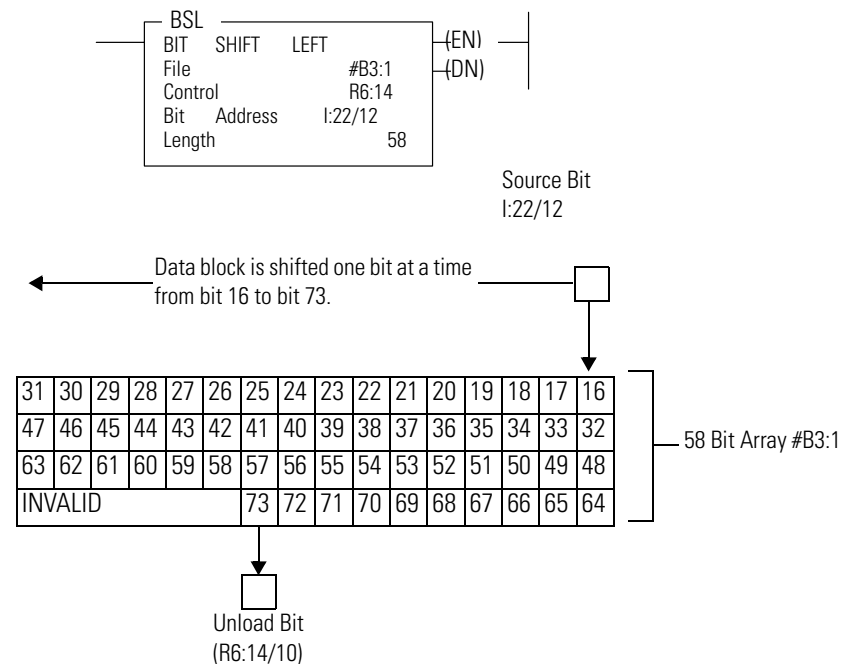

If you wish to shift more than one bit per scan, you must create a loop in your application using the JMP, LBL, and CTU instructions.

## Use BSR

When the rung goes from false-to-true, the enable bit (EN bit 15) is set and the data block is shifted to the right (to a lower bit number) one bit position. The specified bit at the bit address is shifted into the last bit position. The first bit is shifted out of the array and stored in the unload bit (UL bit 10) in the status byte of the control element. The shift is completed immediately.

For wraparound operation, set the position of the bit address to the first bit of the array or to the UL bit, whichever applies.

The figure below illustrates how the Bit Shift Right instruction works.

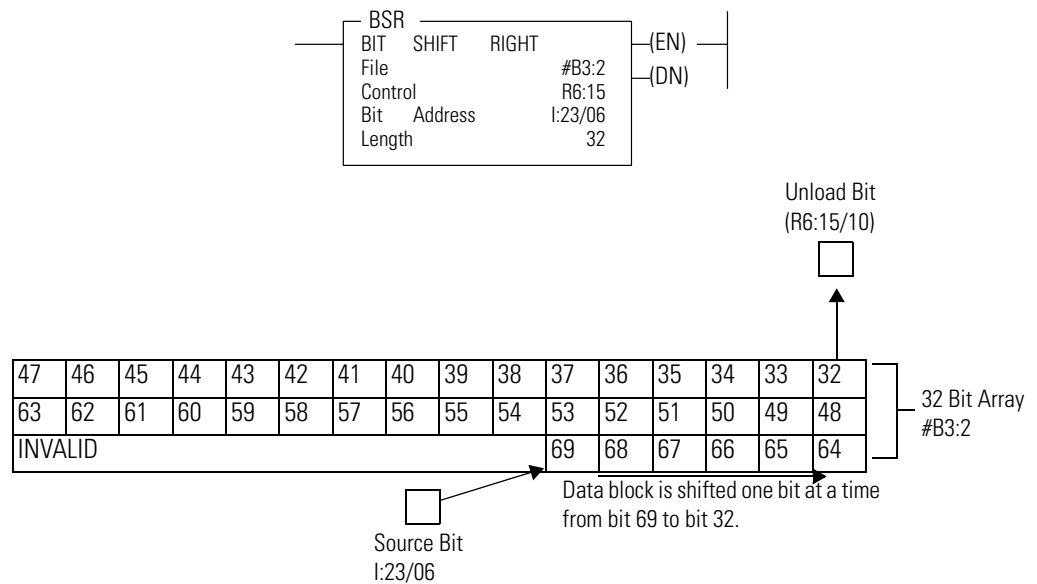

If you wish to shift more than one bit per scan, you must create a loop in your application using the JMP, LBL, and CTU instructions.

## Sequencer Instructions Overview

The following general information applies to sequencer instructions.

### Effects on Index Register S:24

The value present in the index register S:24 is overwritten when the sequencer instruction is true. The index register value will equal the position value of the instruction.

## Applications Requiring More than 16 Bits

When your application requires more than 16 bits, use parallel multiple sequencer instructions.

**TIP** If a String element address is used for the file parameter, the maximum length for SLC 5/03 and higher processors is 41 words. Additionally, String element boundaries cannot be crossed.

### Sequencer Output (SQO) Sequencer Compare (SQC)

These instructions transfer 16-bit data to word addresses for the control of sequential machine operations.

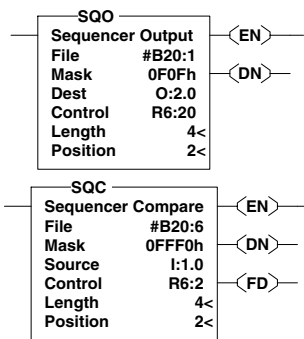

### Enter Parameters

Enter the following parameters when programming these instructions.

- **File** is the address of the sequencer file. You must use the file indicator (#) for this address.

**Table 7.3 Instructions for Sequential Machine Operation**

Instruction	Sequencer File Stores
SQO	Data for controlling outputs
SQC	Reference data for monitoring inputs

Fixed	SLC 5/01	SLC 5/02	SLC 5/03	SLC 5/04	SLC 5/05
•	•	•	•	•	•

Output Instructions

- **Mask** (SQO, SQC) is a hexadecimal code or the address of the mask word or file through which the instruction moves data. Set mask bits to pass data and reset mask bits to mask data. Use a mask word or file if you want to change the mask according to application requirements.

If the mask is a file, its length will be equal to the length of the sequencer file. The two files track automatically.

- **Source** is the address of the input word or file for a SQC from which the instruction obtains data for comparison to its sequencer file.
- **Destination** is the address of the output word or file for a SQO to which the instruction moves data from its sequencer file.

**TIP**

You can address the mask, source, or destination of a sequencer instruction as a word or file. If you address it as a file, the instruction automatically steps through the source, mask, or destination file.

- **Control** (SQO, SQC) is the control structure that stores the status byte of the instruction, the length of the sequencer file, and the instantaneous position in the file. You should not use the control address for any other instruction.

**Table 7.4 Control File Structure**

	15	14	13	12	11	10	09	08	07	06	05	04	03	02	01	00
Word 0	EN		DN		ER			FD	Not Used							
Word 1	Length of sequencer file															
Word 2	Position															

Status bits of the control structure include:

- Found Bit FD (bit 08) - SQC only. When the status of all non-masked bits in the source address match those of the corresponding reference word, the FD bit is set. This bit is assessed each time the SQC instruction is evaluated while the rung is true.
  - Error Bit ER (bit 11) is set when the processor detects a negative position value, or a negative or zero length value. This results in a major error if not cleared before the END or TND instruction is executed.
  - Done Bit DN (bit 13) is set by the SQO or SQC instruction after it has operated on the last word in the sequencer file. It is reset on the next false-to-true rung transition after the rung goes false.
  - Enable EN (bit 15) is set by a false-to-true rung transition and indicates the SQO or SQC instruction is enabled.
- **Length** is the number of steps of the sequencer file starting at position 1. The maximum number you can enter is 255 words. Position 0 is the startup position. The instruction resets (wraps) to position 1 at each cycle completion.

The address assigned for a sequencer file is step zero. Sequencer instructions use length +1 word of data table files for each file referenced in the instruction. This applies to the source, mask, and/or destination if addressed as files.

A length value that points past the end of the programmed file causes a runtime major error to occur.

**TIP**

If you alter a length value with your ladder program, make certain that the altered value is valid.

- **Position** is the word location or step in the sequencer file from/to which the instruction moves data.

A position value that points past the end of the programmed file causes a runtime major error to occur.

**TIP**

You may use the reset (RES) instruction to reset a sequencer. All control bits (except FD) will be reset to zero. The Position will also be set to zero. Program the address of your control register in the RES (for example,R6:0).

## Use SQO

This output instruction steps through the sequencer file whose bits have been set to control various output devices.

When the rung goes from false-to-true, the instruction increments to the next step (word) in the sequencer file. Data stored there is transferred through a mask to the destination address specified in the instruction. Current data is written to the corresponding destination word every scan that the rung remains true.

The done bit is set when the last word of the sequencer file is transferred. On the next false-to-true rung transition, the instruction resets the position to step one.

If the position is equal to zero at startup, when you switch the processor from the program mode to the run mode instruction operation depends on whether the rung is true or false on the first scan.

- If true, the instruction transfers the value in step zero.
- If false, the instruction waits for the first rung transition from false-to-true and transfers the value in step one.



The bits mask data when reset and pass data when set. The instruction will not change the value in the destination word unless you set mask bits. The mask can be fixed or variable. If you enter a hexadecimal code, it is fixed. If you enter an element address or a file address for changing the mask with each step, it is variable.

The following figure indicates how the SQO instruction works.

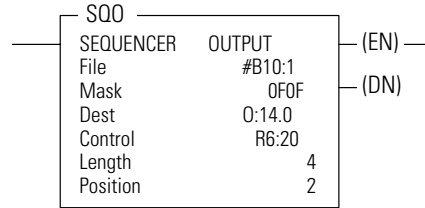

**Destination 0:14.0**

15	8	7	0
0000	0101	0000	1010

**Mask Value 0F0F**

15	8	7	0
0000	1111	0000	1111

**Sequencer Output File #B10:1**

Word					Step
<b>B10:1</b>	0000	0000	0000	0000	<b>0</b>
<b>2</b>	1010	0010	1111	0101	<b>1</b>
<b>3</b>	1111	0101	0100	1010	<b>2</b>
<b>4</b>	0101	0101	0101	0101	<b>3</b>
<b>5</b>	0000	1111	0000	1111	<b>4</b>

← **Current Step**

**External Outputs Associated with 0:14**

00	
01	← <b>ON</b>
02	
03	← <b>ON</b>
04	
05	
06	
07	
08	← <b>ON</b>
09	
10	← <b>ON</b>
11	
12	
13	
14	
15	

## Use SQC

When the status of all non-masked bits in the source word match those of the corresponding reference word, the instruction sets the found bit (FD) in the control word. Otherwise, the found bit (FD) is cleared.

The bits mask data when reset and pass data when set. The instruction will not change the value in the destination word unless you set the mask bits. The mask can be fixed or variable. If you enter a hexadecimal code, it is fixed. If you enter an element address or a file address for changing the mask with each step, it is variable.

When the rung goes from false-to-true, the instruction increments to the next step (word) in the sequencer file. Data stored there is transferred through a mask and compared against the source data for equality. If the source data equals the reference data, the FD bit is set in the SQC's control counter. Current data is compared against the source every scan that the rung evaluates as true.

Applications of the SQC instruction include machine diagnostics. The following figure explains how the SQC instruction works.

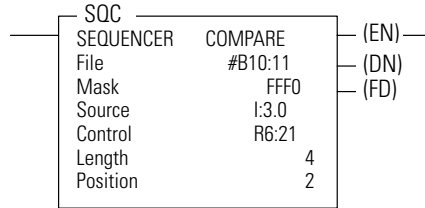

**Input Word I:3.0**

0010	0100	1001	1101
------	------	------	------

**Mask Value FFF0**

1111	1111	1111	0000
------	------	------	------

**Sequencer Ref File #B10:11**

Word		Step
<b>B10:11</b>		<b>0</b>
<b>12</b>		<b>1</b>
<b>13</b>	0010   0100   1001   0000	<b>2</b>
<b>14</b>		<b>3</b>
<b>15</b>		<b>4</b>

SQC FD bit is set when the instruction detects that an input word matches (through mask) its corresponding reference word.

The FD bit R6:21/FD is set in the example, since the input word matches the sequencer reference value using the mask value.

## Sequencer Load (SQL)

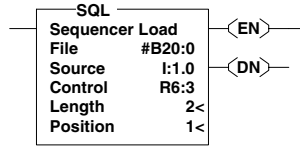

Fixed	SLC 5/01	SLC 5/02	SLC 5/03	SLC 5/04	SLC 5/05
•	•	•	•	•	•

Output Instruction

The SQL instruction stores 16-bit data into a sequencer load file at each step of sequencer operation. The source of this data can be an I/O or storage word address, a file address, or a constant.

### Enter Parameters

Enter the following parameters when programming this instruction.

- **File** is the address of the sequencer file. You must use the indexed file indicator (#) for this address.
- **Source** can be a word address, file address, or a constant (-32768 to 32767).

If the source is a file address, the file length equals the length of the sequencer load file. The two files will step automatically, per the position value.

- **Length** is the number of steps of the sequencer load file (and also of the source if the source is a file address), starting at position 1. The maximum number you can enter is 255 words. Position 0 is the startup position. The instruction resets (wraps) to position 1 at each cycle completion.

The position address assigned for a sequencer file is step zero. Sequencer instructions use length plus one word of data for each file referenced in the instruction. This applies to the source if addressed as a file.

A length value that points past the end of the programmed file causes a runtime major error to occur.

**TIP** If you alter a length value with your ladder program, make certain that the altered value is valid.

- **Position** is the word location or step in the sequencer file to which data is moved.

A position value that points past the end of the programmed file causes a runtime major error to occur.

**TIP** If you alter a length value with your ladder program, make certain that the altered value is valid.

- **Control** is a control file address. The status bits, length value, and position value are stored in this element. Do not use the control file address for any other instruction.

The control element is shown below.

**Table 7.5 Control File Structure**

	15	14	13	12	11	10	9	8	7	6	5	4	3	2	1	0
Word 0	EN		DN		ER				Not Used							
Word 1	Length															
Word 2	Position															

Status bits of the control structure include:

- Error Bit ER (bit 11) is set when the processor detects a negative position value, or a negative or zero length value.
- For SLC processors, this results in a major error if not cleared before the END or TND instruction is executed.
- Done Bit DN (bit 13) is set after the instruction has operated on the last word in the sequencer load file. It is reset on the next false-to-true rung transition after the rung goes false.
- Enable Bit EN (bit 15) is set on a false-to-true transition of the SQL rung and reset on a true-to-false transition.

## Operation

Instruction parameters have been programmed in the SQL instruction shown below. Input word I:1.0 is the source. Data in this word is loaded into integer file #N7:30 by the sequencer load instruction.

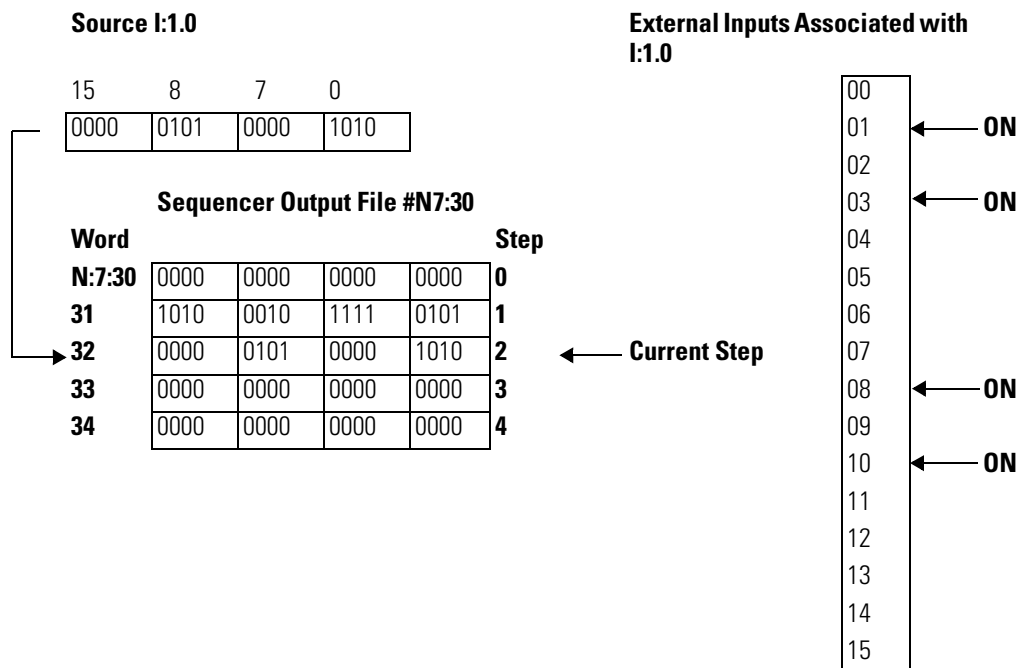
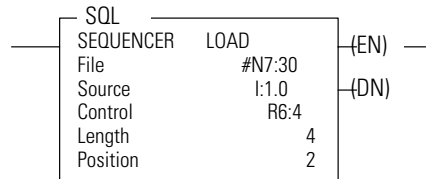

When rung conditions change from false-to-true, the SQL enable bit (EN) is set. The control element R6:4 increments to the next position in the sequencer file, and loads the contents of source I:1.0 into this location. The SQL instruction continues to load the current data into this location each scan that the rung remains true. When the rung goes false, the enable bit (EN) is reset.

The instruction loads data into a new file element at each false-to-true transition of the rung. When step 4 is completed, the done bit (DN) is set. Operation cycles to position 1 at the next false-to-true transition of the rung after position 4.

If the source were a file address such as #N7:40, files #N7:40 and #N7:30 would both have a length of 5 (0 to 4) and would track through the steps together per the position value.

## Read High-speed Clock and Compute Time Difference Overview

TDF and RHC instructions are used together. The RHC is used to record the start and stop time of an event. The TDF is used to calculate the time difference between the recorded start and stop times from the RHC instruction.

### RHC Instruction Operation

SLC 500 maintains a 20-bit integer free running clock. This 20-bit value increments every 10  $\mu$ s. The free running clock is non-retentive, a power cycle resets the free running clock to 0. It is accessed using the RHC instruction. When the RHC rung is true, the instruction moves the current value of the 10  $\mu$ s free running clock into the destination address. If the destination is an integer address, the RHC moves the first 16 least significant bits to the destination address. If the destination is a float address, the instruction converts the 20-bit free running clock integer value into a float and moves this value to the destination address. Once the free running clock reaches 0x000FFFFF (10.48575 seconds), it wraps around to 0 and continues incrementing.

#### TIP

The RHC instruction does have an inherent latency due to execution time. The 20-bit float and 16-bit integer do not have the same amount of latency. A 20-bit float destination has additional latency due to the integer to float conversion. The accuracy of this instruction is based on the latency of the RHC instruction and potential hardware interrupts. See Table 7.6, “Accuracy (in counts: 1 count = 10  $\mu$ s),” for more information.

**Table 7.6 Accuracy (in counts: 1 count = 10  $\mu$ s)**

Processor		Best Case	Worst Case	Typical
SLC 5/05	Integer	1	26	1
	Float	1	29	2
SLC 5/04	Integer	1	26	1
	Float	1	29	2
SLC 5/03	Integer	1	53	2
	Float	2	62	3

**TIP**

Measurements were calculated with both communication channels active and no devices connected to the processor. Worst case accuracy is improved by shutting down an unused communication channel.

## TDF Instruction Operation

When the TDF is evaluated with a true rung state, the instruction calculates the number of 10  $\mu$ s ticks that have elapsed from the Start value to the Stop value and places the result into the Destination location. The TDF instruction with float addresses accurately computes the time difference between the Start and Stop timestamps captured within 10.48575 seconds of each other (1048575 10  $\mu$ s ticks). The TDF with float addresses calculates an invalid result if more than 10.48575 seconds have elapsed between the Start and Stop timestamps. The TDF with integer addresses accurately computes the time difference between the Start and Stop timestamps captured within 655.36 ms of each other (65536 10  $\mu$ s ticks). The TDF with integer address calculates an invalid result if more than 655.36 ms have elapsed between the Start and Stop timestamps. It is up to you to assure that the timestamps are captured within the valid time difference range.



## Read High-speed Clock Instruction (RHC)

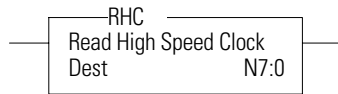

Fixed	SLC 5/01	SLC 5/02	SLC 5/03	SLC 5/04	SLC 5/05
			•	•	•

The Read High-speed Clock Instruction (RHC) provides a high performance timestamp for performance diagnostics and performing calculations such as velocity.

### Enter Parameters

**Destination** - The address to store the current value of the 10  $\mu$ s free running clock. It can be an integer address (Nx:x) or Float address (Fx:x). The integer address supports 16 bits range time (0 to 655.36 ms). The float address gives the exact time for the free running clock value with 20 bits range time (0 to 10.48575 seconds).

## Compute Time Difference Instruction (TDF)

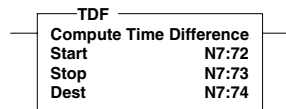

Fixed	SLC 5/01	SLC 5/02	SLC 5/03	SLC 5/04	SLC 5/05
			•	•	•

The compute Time Difference Instruction (TDF) is used to calculate the number of 10  $\mu$ s ticks between any two time-stamps captured using the RHC instruction. This lets your program determine the time difference between any two events using a 10  $\mu$ s timebase.

### Enter Parameters

This instruction has three parameters. All of these parameters should be of the same data type (Nx:x or Fx:x).

- **Start** - The address of the earliest value previously captured using the RHC instruction.
- **Stop** - The address of a later value captured using the RHC instruction.
- **Destination** - The address to store the result of the time difference calculation.

## File Bit Comparison (FBC) and Diagnostic Detect (DDT)

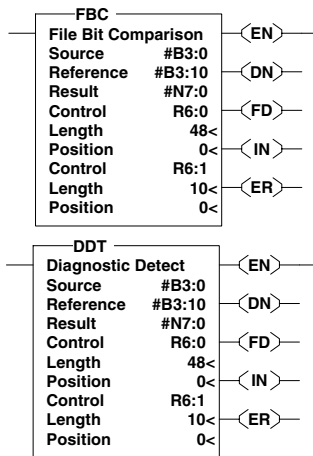

The FBC and DDT diagnostic instructions are output instructions that you use to monitor machine or process operations to detect malfunctions.

**Table 7.7 Available Diagnostic Instructions**

If You Want to Detect Malfunctions By	Use this Instruction
Comparing bits in a file of real-time inputs with a reference bit file that represents correct operation	FBC
Change-of-state diagnostics	DDT

Both the FBC and DDT instructions compare bits in a file of real-time machine or process values (input file) with bits in a reference file, detect deviations, and record mismatched bit numbers. These instructions record the position of each mismatch found and place this information in the result file. If no mismatches are found, the DN bit is set and the result file remains unchanged.

Fixed	SLC 5/01	SLC 5/02	SLC 5/03	SLC 5/04	SLC 5/05
			•	•	•

The difference between the DDT and FBC instruction is that each time the DDT instruction finds a mismatch, the processor changes the reference bit to match the source bit. The FBC instruction does not change the reference bit. Use the DDT instruction to update your reference file to reflect changing machine or process conditions.

### Select the Search Mode

Select whether the diagnostic instruction searches for a mismatch one bit at a time or whether it searches for all mismatches during one program scan.

#### One Bit at a Time

With each false-to-true rung transition, the instruction compares the next bit between the input and reference files. If a mismatch is detected, the instruction stops and sets the found FD bit. Then the instruction enters the position number of the mismatch into the result file.

The DDT instruction also changes the status of the reference bit to match the status of the corresponding input bit. The instructions resets the found bit when the rung goes false.

After the instruction compares the last bit in two files, the done bit (bit 13 DN on the compare control element) is set. Then, when the rung goes false, the instruction resets the:

- enable bit.
- found bit (if set).
- compare done bit.
- result done bit (if set).

The control position counters are reset on the next false-to-true rung transition. To enable this mode of operation, set the inhibit bit (IN=1) either by ladder program or manually before program execution.

### *All Per Scan*

After a false-to-true rung transition, the instruction searches for all mismatches between the input and reference files in one program scan. Upon finding mismatches, the instruction enters the position numbers of mismatched bits into the result file in the order it finds them. After reaching the end of the input and reference files, the instruction sets the FD bit if it finds at least one mismatch. Then the instruction sets the DN bit.

If you use a result file that cannot hold all detected mismatches (if the result file fills), the instruction stops and requires another false-to-true rung transition to continue operation. The instruction wraps the new mismatched bit positions into the beginning of the result file writing over the old.

**TIP**

To detect one mismatch at a time, set the result length value to one.

After completing the comparison and when the rung goes false, the instruction resets the:

- enable bit.
- found bit (if set).
- compare done bit.
- result done bit (if set).

The control position counters are reset on the next false-to-true rung transition. To enable this mode of operation, reset the inhibit bit (IN=0) by ladder program or manually before program execution.

## Enter Parameters

To program these instructions, you need to provide the processor with the following information.

- **Source** - The indexed address of your input file.
- **Reference** - The indexed address of the file that contains the data with which you compare your input file.
- **Result** - The indexed address of the file where the instruction stores the position (bit) number of each detected mismatch.
- **Control** - The control is the address of TWO continuous control structures (i.e. R6:0 and R6:1). The first control structure is a comparison control, which stores status bits, the length of the source and reference files (in bits), and the next bit position during operation. The second control structure is a result control, which stores the bit position number each time the instruction finds a mismatch between source and reference files.

Use the result control address with mnemonic when you address these parameters.

- **Length** (.LEN) is the decimal number of elements in the result file. Make the length long enough to record the maximum number of expected mismatches.
- **Position** (.POS) is the current position in the result file. Enter a value only if you want the instruction to start at an offset concurrent with a control file offset for one scan.

---

**ATTENTION**

Do not use the same address for more than one control structure. Duplication of these addresses could result in unpredictable operation, possibly causing equipment damage and/or injury to personnel.

---

## Use Status Bits

To use the FBC or DDT instruction correctly, examine the control bits in both the comparison and result control elements. You address these bits by mnemonic.

**Table 7.8 FBC and DDT Status Bits**

Bit	Function	
Comparison Control Bits	Enable EN (bit 15)	Starts operation on a false-to-true rung transition. If the IN bit is set for one bit-at-a-time operation, the ladder program must toggle the EN bit after the instruction compares each bit.
	Done DN (bit 13)	Is set when the processor reaches the end of the source and reference files.
	Error ER (bit 11)	Is set when the processor detects an error and stops operation of the instruction. For example, an error occurs if the length (LEN) is less than or equal to zero or if the position (POS) is less than zero. The ladder program must reset the ER bit if the instruction detects an error.
	Inhibit IN (bit 09)	Determines the mode of operation. When this bit is reset, the processor detects all mismatches in one scan. When this bit is set, the processor stops the search at each bit and waits for the ladder program to re-enable the instruction before continuing the search.
	Found FD (bit 08)	Is set each time the processor records a mismatch bit number in the result file (one bit-at-a-time operation) or after recording all mismatches (all per scan).
Result Control Bits	Done DN (bit 13)	Is set when the result file fills. The instruction stops and requires another false-to-true rung transition to reset the result DN bit and then continue. If the instruction finds another mismatch, it wraps the new position number around to the beginning of the file, writing over previous position numbers.

The instruction control bits are reset when the rung's input conditions go false. The instruction control elements reset on a false-to-true rung transition under the following conditions.

- Compare position equals compare length (clears compare position and result position)
- Result position equals result length (clears result position)

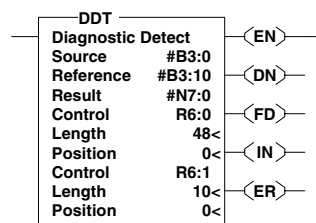

### EXAMPLE

The DDT instruction below compares the bits in the source file (B3:0) with the bits in the reference file (B3:10), recording the mismatched bit positions in the result file (N7:0).

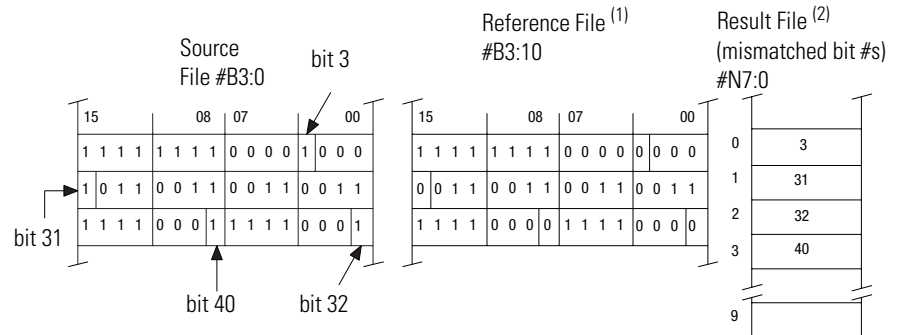

The FBC and DDT instructions detect mismatches and record their locations by bit number in a result file.

- (1) The DDT instruction changes the status of the corresponding bit in the reference file to match the input file when it detects a mismatch.
- (2) The length of the result file is the length that you enter for RESULT CONTROL.

**Table 7.9 FBC and DDT Explanation**

This Parameter	Tells the Processor
Source (B3:0)	Where to find input data for comparison.
Reference (B3:10)	Where to find the reference file.
Results (N7:0)	Where to store mismatched bit numbers.
Compare Control (R6:0)	What control structure controls the comparison.
Length (48)	The number of bits to be compared (2048 max).
Position (0)	To start at the beginning of the file.
Result Control (R6:1)	What control structure controls the result.
Length (10)	The number of words reserved for mismatches (256 max).
Position (0)	To start at the beginning of the file.

## Read Program Checksum (RPC)

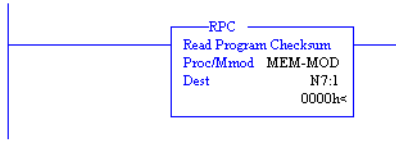

The Read Program Checksum (RPC) instruction copies the checksum of the user ladder program from either the processor's RAM memory or from the installed memory module into the designated destination integer file location. The program checksum is a 16-bit value that is calculated for the entire ladder logic image, excluding the data table values. The checksum changes any time program edits are made. Therefore, the RPC instruction can be used within the ladder logic to determine whether online edits have changed the checksum from a known value or can verify the program in the memory module matches the program in the processor's RAM memory. If a mismatch is detected, additional ladder logic may trigger an alarm bit for a higher level HMI to evaluate or even fault the processor so that it cannot run with a modified program.

Fixed	SLC 5/01	SLC 5/02	SLC 5/03	SLC 5/04	SLC 5/05
			•	•	•

Output Instructions

This instruction requires RSLogix 500 software, version 7.10 or higher, for programming.

### Enter Parameters

- **Proc/Mmod** selects the source of the program checksum; PROC-MEM for processor RAM memory or MEM-MOD for memory module.
- **Destination** is the integer file address where to copy the selected program checksum.

**Notes:**



## Block Transfer Instructions

This chapter contains general information about block transfer instructions and explains how they function in your application program. Each of the block transfer instructions includes information on:

- what the instruction symbol looks like.
- how to use the instruction.

**Table 8.1 Block Transfer Instructions**

Instruction Mnemonic	Instruction Name	Purpose	Page
<b>BTR</b>	Block Transfer Read	A BTR is used to receive data from a remote device.	8-1
<b>BTW</b>	Block Transfer Write	A BTW is used to send data to a remote device.	8-1

### Block Transfer Instructions (BTR and BTW)

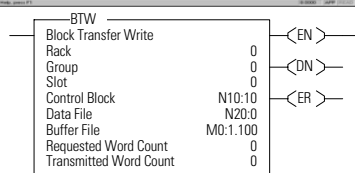

Block transfer instructions are supported by SLC 5/03 (OS302, Series C), SLC 5/04 (OS401, Series C) and SLC 5/05 (OS501, Series C) and higher processors using RSLogix 500 version 4.10 and higher. With block-transfer instructions, you can transfer up to 64 words to or from a remote device over an Allen-Bradley Remote I/O (RIO) link. A Block Transfer Read (BTR) is used to receive data from a remote device. A Block Transfer Write (BTW) is used to send data to a remote device. The RIO Series B scanner (1747-SN) modules and the back-up scanner (1747-BSN) modules perform block transfers via M0 and M1 file buffers.

A false-to-true rung transition initiates a BTW or BTR instruction. The BTW instruction tells the processor to write data stored in the BTW Data File to a device at the specified RIO rack/group/slot address. The BTR instruction tells the processor to read data from a device at the specified RIO rack/group/slot address and store it in the BT Data File. The Data File may be any valid integer, floating point or binary data table file. A total of 32 block transfer buffers are available; you can execute a maximum of 32 different block transfers. Each buffer is made up of 100 consecutive words. The processor runs each block transfer request in the order it is requested. When the processor changes to Program mode, all pending block transfers are cancelled.

Fixed	SLC 5/01	SLC 5/02	SLC 5/03	SLC 5/04	SLC 5/05
			•	•	•

A BTR or BTW instruction writes information into its control structure address (a three-word integer Control Block) when the instruction is entered. The processor uses these values to execute the transfer.

You must enter an M1 file address into BTR Instructions and an M0 file address into BTW Instructions. However, each instruction uses both the M0 and M1 file for that one hundred word buffer (1 through 32). For example, to use the first available buffer (1) for a BTR, enter M1:e.100 into the “Buffer File” field. However, M0:e.100 is also used by this BTR. So, the next BT instruction must use another M-file buffer (2 through 32).

## RIO Block Transfer General Functional Overview

The RIO scanner performs block transfers through control/status buffers allocated in the scanner’s M0 and M1 files. For BTW’s, the data stored in the Data File is copied into the M0 block transfer buffer, the M0 block transfer buffer is then transferred to the RIO device. The corresponding M1 block transfer buffer contains only BTW status information. For BTR’s, the M0 block transfer buffer contains only BTR control information. The actual data read from the remote device is received in the scanner’s M1 block transfer buffer. This data is then copied into the BTR Data File. A total of 32 block transfer control/status buffers exist in the M0 (output/control) and the M1 (input/status) files.

## Entering Parameters for BTR and BTW

The instructions have the following parameters.

- **Data File** - The address in the SLC processor’s data file containing the BTW or BTR data. Valid file types are B, N and F.
- **BTR/BTW Buffer File** - Block transfer buffer file address; i.e. M0: e.x00, where “e” is the slot number of the scanner and “x” is the buffer number. The range of the buffer number is from 1 to 32. Each BTR and BTW instruction uses both the M1 and M0 files for a specific buffer number. M0 is used for BTR control and for BTW data. M1 is used for BTW status and BTR data.

### TIP

Since buffer number 32 is utilized by the SLC processor for Remote I/O passthru, you should not assign buffer number 32 to a block transfer instruction unless you do not intend to ever use Remote I/O passthru.

- **Control** - The control block is an integer data file address that stores all the block transfer control and status information. The control block is three words in length. Note that these integer file addresses should not be used for any other instructions. You should provide the following information for the control structure.
  - **Rack** - The I/O rack number (0 to 3) of the I/O chassis in which you placed the target I/O module.
  - **Group** - The I/O group number (0 to 7) which specifies the position of the target I/O module in the I/O chassis. When using 1/2-slot addressing, only even group numbers are valid.
  - **Slot** - The slot number (0 or 1) within the group. When using 2-slot addressing, the 0 slot is the low (right) slot and the 1 slot is the high (left) slot within the group. When using 1-slot or 1/2-slot addressing, always select slot 0.
  - **Requested Word Count** - The number of words to transfer. If you set the length to 0, the processor reserves 64 words for block transfer data. The block transfer module transfers the maximum words the adapter can handle. If you set the length from 1 to 64, the processor transfers the number of words specified.

**TIP**

The three-word control block has the following structure. Before executing a block transfer, the BTR and BTW instructions clear all status bits and initialize word 2 to 0. See Table 8.2, “Control Block Structure,” for more information.

**Table 8.2 Control Block Structure**

	15	14	13	12	11	10	9	8	7	6	5	4	3	2	1	0
Word 0	EN	ST	DN	ER		EW		TO	RW	Rack			Group			Slot
Word 1	Requested word count															
Word 2	Transmitted word count/Error code															

**Control Status Bits**

To use the BTR and BTW instructions correctly, examine the instruction’s control and status bits stored in the control structure. These bits are mapped to bits in word 0 of the control block structure.

**Figure 8.1 Successful Block Transfer***Successful Block Transfer Read/Write*

Figure 8.1 illustrates a successful BT operation.

1. The SLC control program copies new data to the data file (BTW only) and solves the BT rung true, which sets the enable (EN) bit.
2. The scanner detects that the EN bit is set, validates the control block information, puts the BT request on the RIO link successfully, and since no other BTs are pending for the same logical rack, sets the enable waiting (EW) and start (ST) bits.
3. The scanner receives a BT reply (with no errors) from the RIO link device, copies the received data to the data file (BTR only) and sets the done (DN) bit.
4. The SLC control program detects the DN bit, processes the BTR data and solves the BT rung false, which clears the enable (EN) bit.
5. The scanner detects that the SLC control program has completed processing (because the EN bit is clear) and clears the EW, ST and DN bits. At this point, the SLC control program could re-initiate the same BT operation by solving the BT rung true again.

**TIP**

Except for the time-out bit, TO (bit 08), do not modify any controller status bits while the block transfer is in progress.

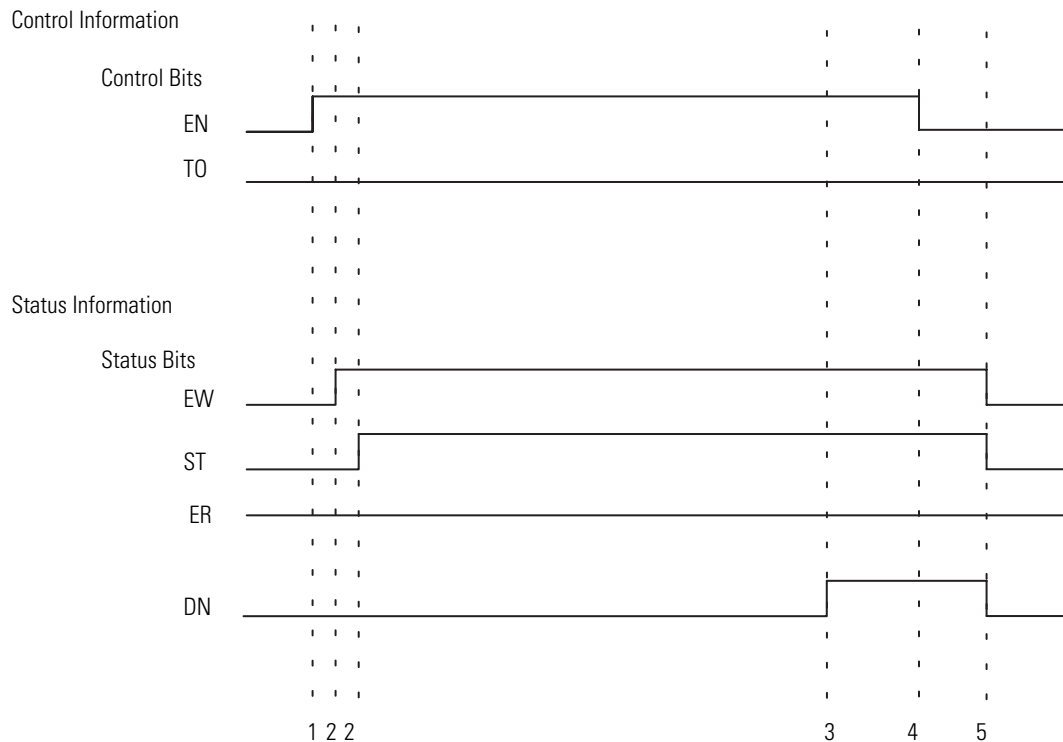
**IMPORTANT**

The BTR/BTW instruction must be scanned (true or false) in order to update the control and status bits.

**TIP**

In order to conserve scan time, place each block transfer instruction in its own subroutine and only call the subroutine while the block transfer instruction is enabled.

**Table 8.3 Control and Status Bit Descriptions**

Control/Status Bit	Description
Enable EN (bit 15)	Block Transfer Enabled - (EN = Enabled). The processor sets/resets this bit depending on the rung state (true/false). The processor sends the enable bit to the RIO scanner when the BTR/BTW instruction is scanned. If the BT is not waiting (EW set) and is not started (ST set), and the EN bit sees a false-to-true transition, the RIO scan triggers a BT.
Start ST (bit 14)	Block Transfer Started - (ST = Started). When the instruction is scanned (true or false), the processor reads this bit from the RIO scanner. The scanner sets this bit when the BT starts. The scanner resets this bit when the ladder logic (processor) clears the EN bit indicating the BT is finished.
Done DN (bit 13)	Block Transfer Successful - (DN = Done). When this bit is set, it indicates the successful completion of a block transfer operation. When the instruction is scanned (true or false), the processor reads the DN bit from the RIO scanner. The scanner clears the DN bit when the ladder logic (processor) clears the EN bit.
Error ER (bit 12)	Block Transfer Error - (ER = Error). When this bit is set, it indicates that the process detected a failed block transfer. When the instruction is scanned (true or false), the processor reads the ER bit from the RIO scanner. The scanner clears the ER bit when the ladder logic (processor) clears the EN bit.
Enable-waiting EW (bit 10)	Block Transfer Enabled and waiting for block transfer to start - (EW = Enable Waiting). When the EW bit is set and the ST bit is clear, this indicates that a block transfer operation is pending. When the instruction is scanned (true or false), the processor reads the EW bit from the scanner. The scanner clears the EW bit after the ladder logic (processor) clears the EN bit.
Time Out TO (bit 08)	Block Transfer Time-out (TO = Time-out). You can set this bit to cancel block transfer operation by forcing the BT to time out once the Enabled Waiting (EW) bit sets and before the RIO scanner's internal four-second block transfer timer times out or the block transfer completes. Cancelling a block transfer causes an error (ER) bit to set and an error code of -9 to display in the control structure. Note that the Time-out (TO) bit must be cleared before initiating a new block transfer. The RIO scanner ignores a block transfer request if both TO and EN bits are set at the same time.
Read-Write RW (bit 07)	Block Transfer Type. This bit is controlled by the instruction type. A "0" indicates a write operation (BTW); a "1" indicates a read operation (BTR).

In addition to the control and status bits, the control block contains two other parameters the processor uses to execute the block transfer instructions.

#### *Requested Word Count, Word 1 (RLEN)*

This is used to configure BTR/BTW length information (0 to 64). Length is the number of BTR/BTW words read from or written to the RIO device. If RLEN = 0 for a BTW instruction, 64 words are sent. If RLEN = 0 for a BTR instruction, the actual length is determined by the RIO device responding to the block transfer read request.

#### *Transmitted Word Count/Error Code, Word 2 (DLEN)*

Transmitted Word Count is the status of the actual number of BTW words sent or the number of BTR words received. The processor uses this number to verify the transfer. This number should match the requested word count (unless the transmitted word count is zero). If these numbers do not match, the processor sets the ER bit (bit 12). If there is an error, the processor gives the error code in Word 2 of the control structure in the form of a negative number. See Table 8.4, “BTR/BTW Error Codes,” for a list of error codes. Only one error code is stored at a time (a new error code overwrites the previous error code).

**Table 8.4 BTR/BTW Error Codes**

<b>Error Code</b>	<b>Description</b>
0	The block transfer completed successfully.
-6	Illegal block transfer length requested.
-7	Block transfer communication error occurred when block transfer request was initiated.
-8	Error in block transfer protocol.
-9	Block Transfer Time-out - Either the SLC user program cancelled the block transfer or the scanner's block transfer timer timed out. Note that a time-out error occurs if a block transfer is attempted at a location that is not configured for block transfer operation (for example, requesting a block transfer for a location that is an output module).
-10	No RIO channel configured.
-11	Attempted a block transfer either to a non-configured block transfer device (i.e., an invalid logical rack, group, or slot), or at a complementary device location where there is no corresponding primary image space allocated.
-12	Attempted a block transfer to an inhibited device.

## Instruction Operation

1. The scanner processes the BTR/BTW when it detects that the SLC control program rung, which contains the BTR/BTW, goes true.

If the RIO scanner detects any problem at this point (such as invalid block transfer control field, or unconfigured device), the control structure word 2 fills with the error code and the ER bit (bit 12) is set. If no problems occur, the EW bit (bit 10) and ST bit (bit 14) are set in the control block.

### TIP

The ST bit is not set if the scanner is already in the process of block transferring data to a location within the same logical RIO rack. The ST bit is set only after any previous pending block transfers to the same logical rack are completed and the block transfer request is scheduled on the RIO link.

The SLC control program can monitor the block transfer by examining bits in word 0 of the control block. They indicate when the scanner has started processing (EW and ST) the block transfer and whether the block transfer operation completed successfully (DN) or failed (ER). The SLC control program can take different actions based on these status bits.

2. When a block transfer completes successfully, the DN bit is set. This indicates that the block transfer control block has been updated with the actual transmitted word count. This is important for BTR instructions, because this indicates the number of valid data words received from the remote device. This data is stored in the BTR data file.
3. If the block transfer fails, the length field and the data file are not updated. The ER bit is set and the error code field indicates the problem.
4. The SLC control program must indicate to the scanner when it is done processing the status word in the control structure (because DN or ER was set) so the corresponding control bits can be reused for another block transfer operation. The SLC control program indicates that it is done processing the block transfer when it solves the BT rung false, which clears the EN bit in the control block.
5. When the RIO scanner detects that the EN bit cleared, it then clears the EW, ST and DN or ER bits, as well as the Transmitted Word Count/Error Code. This ensures that the status bits in the control block are not reflecting the results of the previous block transfer operation.

**IMPORTANT** To prevent configuration conflicts, it is highly recommended that each M-file buffer (My:e.x00) should be used by only one block transfer instruction.

### Programming Examples

**Table 8.5 Block Transfer Programming Examples**

Figure 8.2, "Directional" on page 8-8
Figure 8.3, "Directional Repeating" on page 8-9
Figure 8.4, "Directional Continuous" on page 8-9
Figure 8.5, "Bi-directional Continuous" on page 8-9
Figure 8.6, "Bi-directional Alternating" on page 8-10
Figure 8.7, "Bi-directional Alternating Repeating" on page 8-10

**Figure 8.2 Directional**

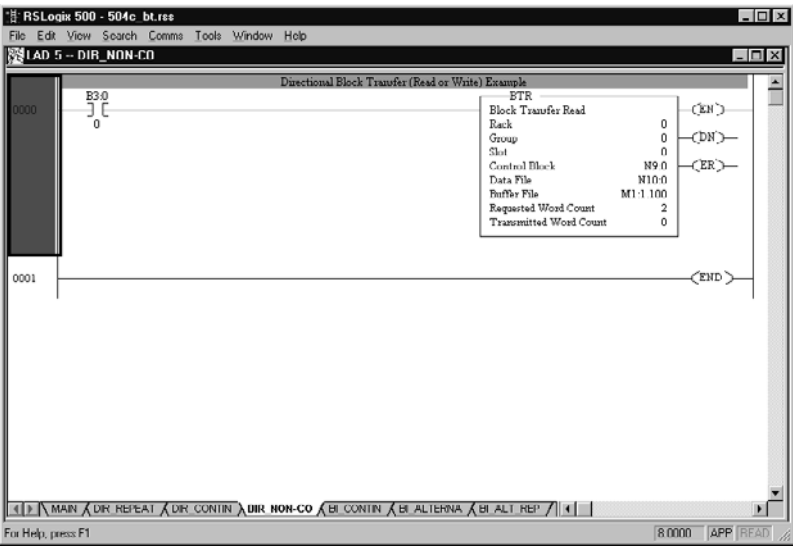



Figure 8.3 Directional Repeating

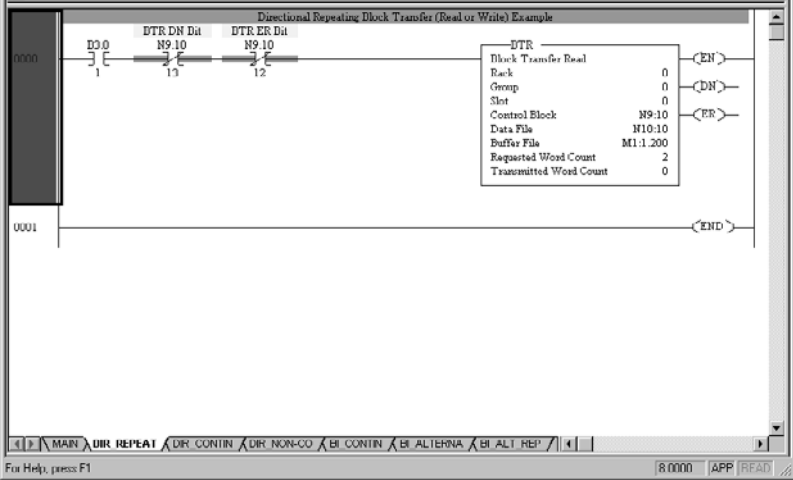

Figure 8.4 Directional Continuous

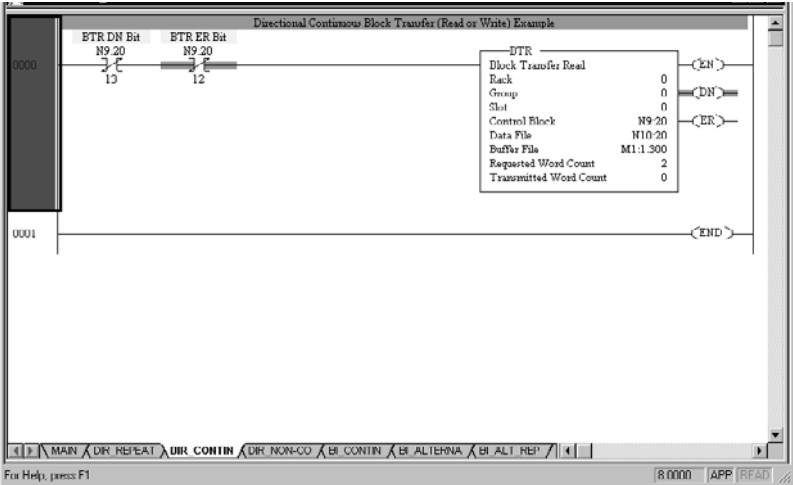

Figure 8.5 Bi-directional Continuous

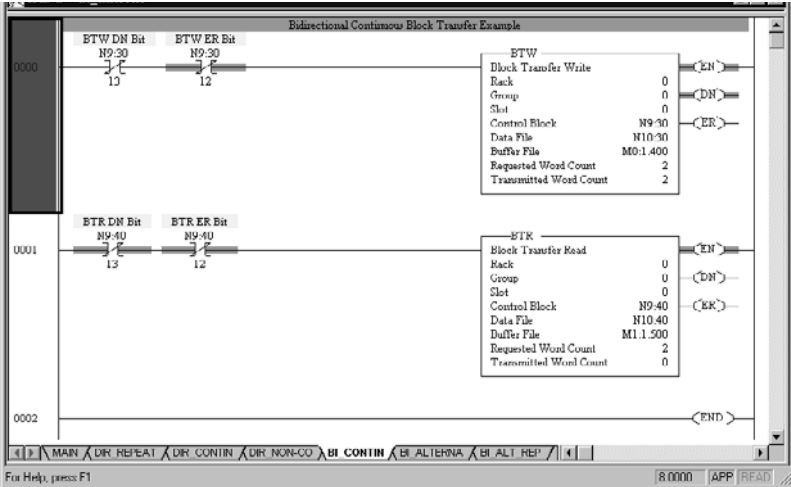

Figure 8.6 Bi-directional Alternating

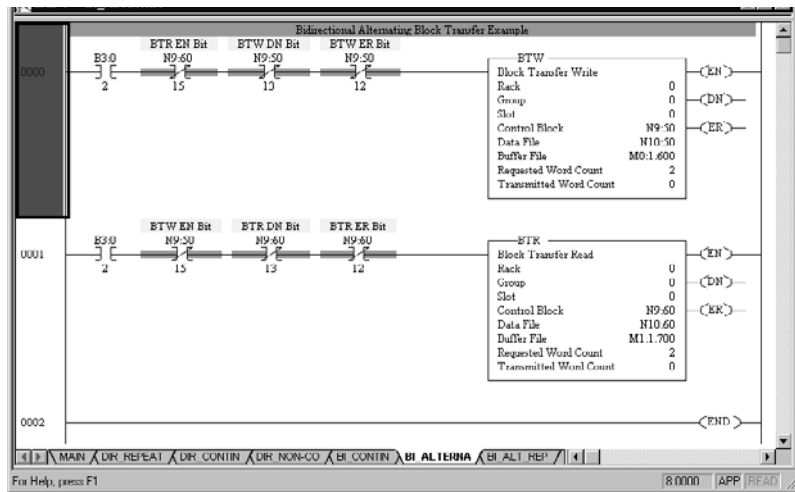
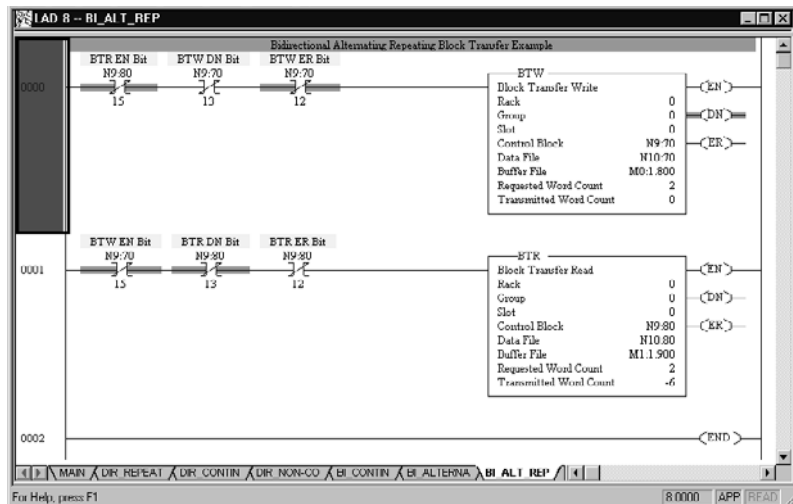

Figure 8.7 Bi-directional Alternating Repeating



## Comparison to the PLC-5 BTR and BTW

BTR/BTW in SLC processors are quite similar to the instructions in the PLC-5. However, some differences exist between them, as shown in the table below.

**Table 8.6 Block Transfer Comparison**

Parameter	SLC	PLC-5
Control Block	3-element integer (N) type	5-element integer (N) type or 1-element block transfer (BT) type.
EN (Enable Bit)	Follows BT rung state.	Gets set when BT rung goes true. Remains set until the BT finishes or fails, and the BT rung goes false.
NR (No Response bit)	None	This bit is in control block word 0 bit 9.
CO (Continuous bit)	None	This bit is in control block word 0 bit 11.
FILE (File Number)	None	This word is control block word 3.
ELEM (Element Number)	None	This word is control block word 4.
Error Codes	7 error codes	11 error codes
BTR/BTW number limitation for one scanner/channel	32	64
BT Status Bits	Can only change when BT rung is scanned.	Can change at any point in the program scan.

### IMPORTANT

Do not manipulate the I/O image words of the RIO scanner for modules you are block transferring to. These words are used by the RIO scanner and the remote device as block transfer handshake bits. Any manipulation of them by the user program while a block transfer is in progress causes the block transfer to fail.

**Notes:**

# Proportional Integral Derivative Instruction

This chapter describes the Proportional Integral Derivative (PID) instruction.

## Overview

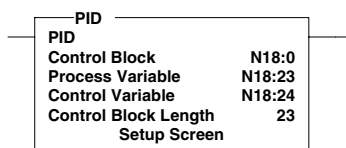

Fixed	SLC 5/01	SLC 5/02	SLC 5/03	SLC 5/04	SLC 5/05
		•	•	•	•

Output Instruction

This is an output instruction that controls physical properties such as temperature, pressure, liquid level, or flow rate using process loops.

The PID instruction normally controls a closed loop using inputs from an analog input module and provides an output to an analog output module. For temperature control, you can convert the analog output to a time proportioning on/off output for driving a heater or cooling unit. An example appears on pages 9-30 through 9-31.

The PID instruction can be operated in the timed mode or the STI mode. In the timed mode, the instruction updates its output periodically at a user-selectable rate. In the STI mode, the instruction should be placed in an STI interrupt subroutine. It then updates its output every time the STI subroutine is scanned. The STI time interval and the PID loop update rate must be the same in order for the equation to execute properly.

## The PID Concept

PID closed loop control holds a process variable at a desired set point. A flow rate/fluid level example is shown below.

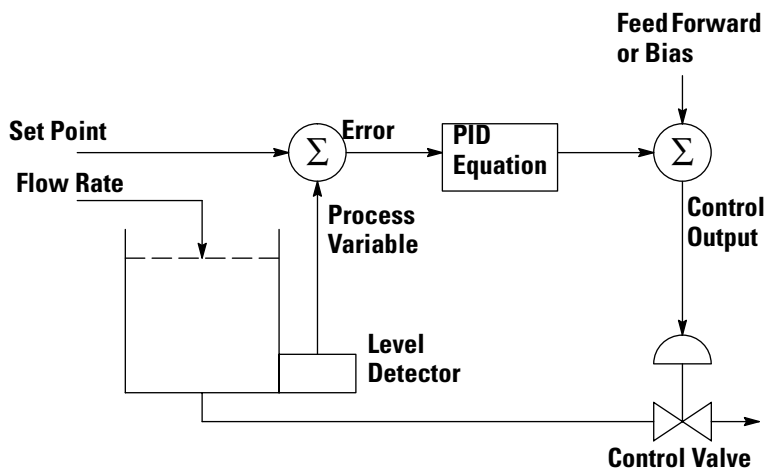

The PID equation controls the process by sending an output signal to the control valve. The greater the error between the setpoint and process variable input, the greater the output signal, and vice versa. An additional value (feed forward/bias) can be added to the control output as an offset. The result of PID calculation (control variable) drives the process variable you are controlling toward the set point.

## The PID Equation

The PID instruction uses the following algorithm:

Standard equation with dependent gains is shown below.

$$\text{Output} = K_C \left[ (E) + \frac{1}{T_I} \int (E)dt + T_D \cdot \frac{D(PV)}{df} \right] + \text{Feed Forward/Bias}$$

Standard Gains constants are listed in the following table.

**Table 9.1 Standard Gain Constants**

Term	Range (Low to High)	Reference
Controller Gain $K_C$	0.1 to 25.5 (dimensionless) <sup>(1)</sup> 0.01 to 327.67 (dimensionless) <sup>(2)</sup>	Proportional
Reset Term $1/T_I$	25.5 to 0.1 (minutes per repeat) <sup>(1)</sup> 327.67 to 0.01 (minutes per repeat) <sup>(2)</sup>	Integral
Rate Term $T_D$	0.1 to 25.5 (minutes) <sup>(1)</sup> 0.01 to 327.67 (minutes) <sup>(2)</sup>	Derivative

<sup>(1)</sup> SLC 5/02 processors.

<sup>(2)</sup> Applies to SLC 5/03 and higher processors PID ranges when bit Reset and Gain Range (RG) bit is set to 1.

The derivative term (rate) provides smoothing by means of a low-pass filter. The cutoff frequency of the filter is 16 times greater than the corner frequency of the derivative term.

## The PID Instruction

The figure below shows a PID instruction with typical addresses for these parameters entered.

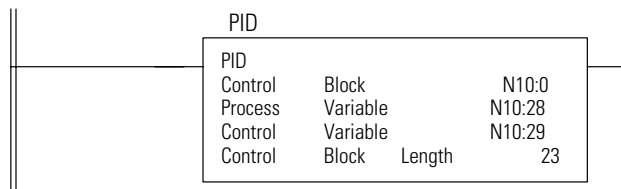

Place the PID instruction on a rung without any conditional logic. If a PID instruction goes false, the integral term is cleared.

### TIP

The PID instruction is an integer-only type of PID algorithm and does not allow you to enter floating point values for any of its parameters. If you attempt to move a floating point value to one of the PID parameters using ladder logic, a floating point-to-integer conversion occurs.

During programming, enter the Control Block, Process Variable, and Control Variable addresses after you have placed the PID instruction on a rung.

## Entering Parameters

- **Control Block** is a file that stores the data required to operate the instruction. The file length is fixed at 23 words and should be entered as an integer file address. For example, an entry of N10:0 will allocate elements N10:0 through N10:22. The control block layout is shown on page 9-5.

Do not write to control block addresses with other instructions in your program except as described later in this chapter. If you are re-using a block of data which was previously allocated for some other use, it is good practice to first zero the data.

### TIP

Use a unique data file to contain your PID control blocks (for example, N10:0). This avoids accidental re-use of the PID control block addresses by other instructions in your program.

- **Process Variable PV** is an element address that stores the process input value. This address can be the location of the analog input word where the value of the input A/D is stored. This value could also be an integer value if you choose to pre-scale your input value to the range 0 to 16383.
- **Control Variable CV** is an element address that stores the output of the PID instruction. The output value ranges from 0 to 16383, with 16383 being the 100% on value. This is normally an integer value, so that you can scale the PID output range to the particular analog range your application requires.

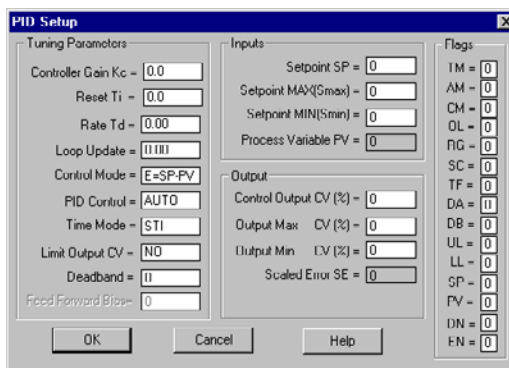



## PID Control Block Layout

The control block length is fixed at 23 words and should be programmed as an integer file. PID instruction flags (word 0) and other parameters are listed in the following table.

**Table 9.2 Control Block Structure**

	15	14	13	12	11	10	09	08	07	06	05	04	03	02	01	00
Word 0	EN	RA <sup>(1)</sup>	DN	PV	SP	LL	UL	DB	DA <sup>(2)</sup>	TF	SC	RG <sup>(2)</sup>	OL <sup>(3)</sup>	CM <sup>(3)</sup>	AM <sup>(3)</sup>	TM <sup>(3)</sup>
Word 1	PID Sub Error Code (MSbyte)															
Word 2	Setpoint SP															
Word 3	Gain $K_c$															
Word 4	Reset $T_i$															
Word 5	Rate $T_d$															
Word 6	Feed Forward/Bias															
Word 7	Setpoint Max (SMax)															
Word 8	Setpoint Min (SMin)															
Word 9	Deadband															
Word 10	Internal Use Do Not Change															
Word 11	Output Max															
Word 12	Output Min															
Word 13	Loop Update															
Word 14	Scaled Process Variable															
Word 15	Scaled Error SE															
Word 16	Output CV% (0 to 100%)															
Word 17	MSW Integral Sum															
Word 18	LSW Integral Sum															
Word 19	Internal Use Do Not Change															
Word 20	Internal Use Do Not Change															
Word 21	Internal Use Do Not Change															
Word 22	Internal Use Do Not Change															

<sup>(1)</sup> Applies to SLC 5/03 and higher processors with OS Series C FRN 11 and higher firmware.

<sup>(2)</sup> Applies to the SLC 5/03 and higher processors.

<sup>(3)</sup> You may alter the state of these values with your ladder program.

### ATTENTION



Do not alter the state of any PID control block value unless you fully understand its function and related effect on your process.

## Controller Gain ( $K_c$ )

**Table 9.3 Controller Gain Parameter**

Tuning Parameter Descriptions	Address	Data Format	Range	Type	User Program Access
KC - Controller Gain	Word 3	word (INT)	0 to 32,767	control	read/write

Gain  $K_c$  (word 3) is the proportional gain, ranging from 0 to 3276.7 (when RG = 0), or 0 to 327.67 (when RG = 1). Set this gain to one-half the value needed to cause the output to oscillate when the reset ( $T_i$ ) and rate terms ( $T_d$ ) (below) are set to zero.

### TIP

Controller gain is affected by the reset and gain range (RG) bit. For information, see Reset and Gain Enhancement Bit (RG) on page 9-10.

## Reset Term ( $T_i$ )

**Table 9.4 Reset Term Parameter**

Tuning Parameter Descriptions	Address	Data Format	Range	Type	User Program Access
TI - Reset Term - $T_i$	Word 4	word (INT)	0 to 32,767	control	read/write

Reset Term  $T_i$  (word 4) is the Integral gain, ranging from 0 to 3276.7 (when RG = 0), or 327.67 (when RG = 1) minutes per repeat. Set the reset time equal to the natural period measured in the above gain calibration. A  $K_c$  value of 1 adds the maximum integral term into the PID equation.

### TIP

Reset term is affected by the reset and gain range (RG) bit. For information, see Reset and Gain Enhancement Bit (RG) on page 9-10.

## Rate Term ( $T_d$ )

**Table 9.5 Rate Term Parameter**

Tuning Parameter Descriptions	Address	Data Format	Range	Type	User Program Access
TD - Rate Term - $T_d$	Word 5	word (INT)	0 to 32,767	control	read/write

Rate  $T_d$  (word 5) is the Derivative term. The adjustment range is 0 to 327.67 minutes. Set this value to 1/8 of the integral gain  $T_i$ .

### TIP

This word is not affected by the reset and gain range (RG) bit. For information, see Reset and Gain Enhancement Bit (RG) on page 9-10.

## Feed Forward/Bias

Applications involving transport lags may require that a bias be added to the CV output in anticipation of a disturbance. This bias can be accomplished using the processor by writing a value to the Feed Forward/Bias element, the seventh element (word 6) in the control block file (See page 9-5.) The value you write is added to the output, allowing a feed forward action to take place. You may add a bias by writing a value between -16383 and +16383 to word 6 with your programming terminal or ladder program.

## Mode (TM)

**Table 9.6 Mode Bit Parameter**

Tuning Parameter Descriptions	Address	Data Format	Range	Type	User Program Access
TM - Mode	Word 0, Bit 0	binary	0 or 1	control	read/write

The mode bit specifies when the PID is in timed mode (1) or STI mode (0). This bit can be set or cleared by instructions in your ladder program.

When set for timed mode, the PID executes and updates the CV at the rate specified in the loop update parameter (word 13).

When set for STI mode, the PID executes and updates the CV every time the PID instruction is scanned in the control program. When you select STI, program the PID instruction in the STI interrupt subroutine. The STI routine should have a time interval equal to the setting of the PID “loop update” parameter. Set the STI period in word S:30. For example, if the loop update time contains the value 10 (for 100 ms), then the STI time interval must also equal 100 (for 100 ms).

**TIP**

When using timed mode, your processor scan time should be at least ten times faster than the loop update time to prevent timing inaccuracies or disturbances.

## Loop Update

**Table 9.7 Loop Update Parameter**

Tuning Parameter Descriptions	Address	Data Format	Range	Type	User Program Access
Loop Update	Word 13	word (INT)	1 to 1024	control	read/write

The loop update (word 13) is the time interval between PID calculations. The entry is in 0.01 second intervals. Enter a loop update time five to ten times faster than the natural period of the load. The natural period of the load is determined by setting the reset and rate parameters to zero and then increasing the gain until the output begins to oscillate. When in STI mode, this value must equal the STI time interval value loaded in S:30. The valid range is 0.01 to 10.24 seconds. See page 11-12 for help entering STI setpoint.

## Deadband

**Table 9.8 Deadband Parameter**

Tuning Parameter Descriptions	Address	Data Format	Range	Type	User Program Access
DB - Deadband	Word 9	word (INT)	0 to 32,767	control	read/write

The deadband extends above and below the setpoint by the value entered. The deadband is entered at the zero crossing of the process variable and the setpoint. This means that the deadband is in effect only after the process variable enters the deadband *and* passes through the setpoint.

The valid range is 0 to the scaled maximum, or 0 to 16,383 when no scaling exists.

## Scaled Error

**Table 9.9 Scaled Error Parameter**

Tuning Parameter Descriptions	Address	Data Format	Range	Type	User Program Access
Scaled Error	Word 15	word (INT)	-32,768 to +32,767	status	read only

Scaled error is the difference between the process variable and the setpoint. The format of the difference ( $E = SP - PV$  or  $E = PV - SP$ ) is determined by the control mode (CM) bit. See Control (CM) on page 9-10.

## Auto / Manual (AM)

**Table 9.10 Automatic/Manual Parameter**

Tuning Parameter Descriptions	Address	Data Format	Range	Type	User Program Access
AM - Automatic/Manual	Word 0, Bit 1	binary (bit)	0 or 1	control	read/write

The auto/manual bit can be set or cleared by instructions in your ladder program. When off (0), it specifies automatic operation. When on (1), it specifies manual operation. In automatic operation, the instruction controls the control variable (CV). In manual operation, the user/control program controls the CV. During tuning, set this bit to manual.

### TIP

Output limiting is also applied when in manual.

## Control (CM)

**Table 9.11 Control Mode Parameter**

Tuning Parameter Descriptions	Address	Data Format	Range	Type	User Program Access
CM - Control Mode	Word 0, Bit 2	binary (bit)	0 or 1	control	read/write

Control mode, or forward-/reverse-acting, toggles the values  $E=SP-PV$  and  $E=PV-SP$ .

When set (1) - Forward acting ( $E=PV-SP$ ) causes the control variable to increase when the process variable is greater than the setpoint.

When cleared (0) - Reverse acting ( $E=SP-PV$ ) causes the control variable to decrease when the process variable is greater than the setpoint.

## Deadband (DB)

**Table 9.12 Deadband Parameter**

Tuning Parameter Descriptions	Address	Data Format	Range	Type	User Program Access
DB - PV in Deadband	Word 0, Bit 8	binary (bit)	0 or 1	status	read/write

This bit is set (1) when the process variable is within the zero-crossing deadband range.

## Reset and Gain Enhancement Bit (RG)

**Table 9.13 Reset and Gain Parameter**

Tuning Parameter Descriptions	Address	Data Format	Range	Type	User Program Access
RG - Reset and Gain Enhancement	Word 0, Bit 4	binary (bit)	0 or 1	control	read/write

When set (1), the reset and gain range enhancement bit (RG) causes the reset minute/repeat value (TI) and the gain multiplier (KC) to be divided by a factor of 10. That means a reset multiplier of 0.01 and a gain multiplier of 0.01.

When clear (0), this bit allows the reset minutes/repeat value and the gain multiplier value to be evaluated with a reset multiplier of 0.1 and a gain multiplier of 0.1.

*Example with the RG bit set:* The reset term (TI) of 1 indicates that the integral value of 0.01 minutes/repeat (0.6 seconds/repeat) is applied to the PID integral algorithm. The gain value (KC) of 1 indicates that the error is multiplied by 0.01 and applied to the PID algorithm.

*Example with the RG bit clear:* The reset term (TI) of 1 indicates that the integral value of 0.1 minutes/repeat (6.0 seconds/repeat) is applied to the PID integral algorithm. The gain value (KC) of 1 indicates that the error is multiplied by 0.1 and applied to the PID algorithm.

**TIP**

The rate multiplier (TD) is not affected by this selection. Valid on SLC 5/03 and higher processors.

## Setpoint Scaling (SC)

**Table 9.14 Setpoint Scaling Parameter**

Tuning Parameter Descriptions	Address	Data Format	Range	Type	User Program Access
SC - Setpoint Scaling	Word 0, Bit 5	binary (bit)	0 or 1	control	read/write

The SC bit is cleared when setpoint scaling values are specified.

## Loop Update Time Too Fast (TF)

**Table 9.15 Loop Update Time Too Fast Parameter**

Tuning Parameter Descriptions	Address	Data Format	Range	Type	User Program Access
TF - Loop Update Too Fast	Word 0, Bit 6	binary (bit)	0 or 1	status	read/write

The TF bit is set by the PID algorithm if the loop update time specified cannot be achieved by the controller due to scan time limitations.

If this bit is set, correct the problem by updating your PID loop at a slower rate or move the PID instruction to an STI interrupt routine. Reset and rate gains will be in error if the instruction operates with this bit set.

## Derivative Rate Action Bit (DA)

**Table 9.16 Derivative Rate Action Bit Parameter**

Tuning Parameter Descriptions	Address	Data Format	Range	Type	User Program Access
DA - Derivative Action Bit	Word 0, Bit 7	binary (bit)	0 or 1	control	read/write

When set (1), the derivative (rate) action (DA) bit causes the derivative (rate) calculation to be evaluated on the error instead of the process variable (PV). When clear (0), this bit allows the derivative (rate) calculation to be evaluated where the derivative is performed on the PV.

## Output Alarm Upper Limit (UL)

**Table 9.17 Output Alarm Upper Limit Parameter**

Tuning Parameter Descriptions	Address	Data Format	Range	Type	User Program Access
UL - Output Alarm Upper Limit	Word 0, Bit 9	binary (bit)	0 or 1	status	read/write

The control variable upper limit alarm bit is set (1) when the calculated CV output exceeds the upper CV limit.

## Output Alarm Lower Limit (LL)

**Table 9.18 Output alarm Lower Limit Parameter**

Tuning Parameter Descriptions	Address	Data Format	Range	Type	User Program Access
LL - Output Alarm Lower Limit	Word 0, Bit 10	binary (bit)	0 or 1	status	read/write

The control variable lower limit alarm bit is set (1) when the calculated CV output is less than the lower CV limit.



## Setpoint Out Of Range (SP)

**Table 9.19 Setpoint Out Of Range Parameter**

<b>Tuning Parameter Descriptions</b>	<b>Address</b>	<b>Data Format</b>	<b>Range</b>	<b>Type</b>	<b>User Program Access</b>
SP - Setpoint Out of Range	Word 0, Bit 11	binary (bit)	0 or 1	status	read/write

This bit is set (1) when the setpoint:

- exceeds the maximum scaled value, or
- is less than the minimum scaled value.

## PV Out Of Range (PV)

**Table 9.20 PV Out Of Range Parameter**

<b>Tuning Parameter Descriptions</b>	<b>Address</b>	<b>Data Format</b>	<b>Range</b>	<b>Type</b>	<b>User Program Access</b>
PV - PV Out of Range	Word 0, Bit 12	binary (bit)	0 or 1	status	read/write

The process variable out of range bit is set (1) when the unscaled process variable (PV):

- exceeds 16,383, or
- is less than zero.

## PID Done (DN)

**Table 9.21 PID Done Parameter**

<b>Tuning Parameter Descriptions</b>	<b>Address</b>	<b>Data Format</b>	<b>Range</b>	<b>Type</b>	<b>User Program Access</b>
DN - PID Done	Word 0, Bit 13	binary (bit)	0 or 1	status	read only

The PID done bit is set (1) for one scan when the PID algorithm is computed. It resets automatically.

## PID Rational Approximation Bit (RA)

**Table 9.22 PID Rational Approximation Parameter**

Tuning Parameter Descriptions	Address	Data Format	Range	Type	User Program Access
RA - Rational Approximation	Word 0, Bit 14	binary (bit)	0 or 1	control	read/write

When the RA bit is set, rational approximation method is used for PID computation, resulting in a more accurate output.

## PID Enable (EN)

**Table 9.23 PID Enable Parameter**

Tuning Parameter Descriptions	Address	Data Format	Range	Type	User Program Access
EN - PID Enable	Word 0, Bit 15	binary (bit)	0 or 1	status	read only

The PID enabled bit is set (1) whenever the PID instruction is enabled. It follows the rung state.

## Integral Sum

**Table 9.24 Integral Sum Parameter**

Tuning Parameter Descriptions	Address	Data Format	Range	Type	User Program Access
Integral Sum	Word 17 and 18	long word (32-bit INT)	-2,147,483,648 to 2,147,483,647	status	read/write

This is the result of the integration  $\frac{1}{T_I} \int E(dt)$ .

## Input Parameters

The table below shows the input parameter addresses, data formats, and types of user program access. See the indicated pages for descriptions of each parameter.

**Table 9.25 Input Parameters**

Input Parameter Descriptions	Address	Range	Type	User Program Access	For More Information
SP - Setpoint	Word 2	0 to 16383 <sup>(2)</sup>	control	read/write	9-15
SPV - Process Variable Scaled	Word 14	0 to 16383	status	read only	9-16
SMAX - Maximum Setpoint <sup>(1)</sup>	Word 7	0 to 16383 <sup>(3)</sup>	control	read/write	9-16
SMIN - Minimum Setpoint	Word 8	0 to 16383 <sup>(4)</sup>	control	read/write	9-17

<sup>(1)</sup> The SMAX must be greater than SMIN or the processor will fault with error code.

<sup>(2)</sup> The range listed in the table is for when scaling is not enabled. With scaling, the range is from minimum scaled (SMIN) to maximum scaled (SMAX).

<sup>(3)</sup> Maximum SP scaling range: SLC 5/02 is -16382 to +16383; SLC 5/03 and higher is -32767 to +32767.

<sup>(4)</sup> Minimum SP scaling range: SLC 5/02 is -16383 to +16382; SLC 5/03 and higher is -32768 to +32766.

## Setpoint (SP)

**Table 9.26 Setpoint Parameter**

Input Parameter Descriptions	Address	Data Format	Range	Type	User Program Access
SP - Setpoint	Word 2	word (INT)	0 to 16383 <sup>(1)</sup>	control	read/write

<sup>(1)</sup> The range listed in the table is for when scaling is not enabled. With scaling, the range is from minimum scaled (SMIN) to maximum scaled (SMAX).

The SP (Setpoint) is the desired control point of the process variable.

## Scaled Process Variable (SPV)

**Table 9.27 Scaled Process Variable Parameter**

<b>Input Parameter Descriptions</b>	<b>Address</b>	<b>Data Format</b>	<b>Range</b>	<b>Type</b>	<b>User Program Access</b>
SPV - Scaled Process Variable	Word 14	word (INT)	0 to 16383	control	read/write

The SPV (Scaled Process Variable) is the analog input variable. If scaling is enabled, the range is the minimum scaled value (SMIN) to maximum scaled value (SMAX).

If the SPV is configured to be read in engineering units, then this parameter corresponds to the value of the process variable (PV) in engineering units.

## Setpoint Maximum Scaled (SMAX)

**Table 9.28 Setpoint Maximum Scaled Parameter**

<b>Input Parameter Descriptions</b>	<b>Address</b>	<b>Data Format</b>	<b>Range</b>	<b>Type</b>	<b>User Program Access</b>
SMAX - Maximum Scaled	Word 7	word (INT)	-32,767 to +32,767 <sup>(1)</sup>	control	read/write

<sup>(1)</sup> SLC 5/02 valid range is -16382 to +16383.

If the SPV is read in engineering units, then the SMAX (Setpoint Maximum) parameter corresponds to the value of the setpoint in engineering units when the control input is at its maximum value.

## Setpoint Minimum Scaled (SMIN)

**Table 9.29 Setpoint Minimum Scaled Parameter**

<b>Input Parameter Descriptions</b>	<b>Address</b>	<b>Data Format</b>	<b>Range</b>	<b>Type</b>	<b>User Program Access</b>
SMIN - Minimum Scaled	Word 8	word (INT)	-32,768 to +32,766 <sup>(1)</sup>	control	read/write

<sup>(1)</sup> SLC 5/02 valid range is -16383 to +16382.

If the SPV is read in engineering units, then the SMIN (Setpoint Minimum) parameter corresponds to the value of the setpoint in engineering units when the control input is at its minimum value.

### TIP

*SMIN* - *SMAX* scaling allows you to work in engineering units. The deadband, error, and SPV are also displayed in engineering units. The process variable, PV, must be within the range of 0 to 16383. Use of *SMIN* - *SMAX* does not minimize PID PV resolution.

## Output Parameters

The table below shows the output parameter addresses, data formats, and types of user program access. See the indicated pages for descriptions of each parameter.

**Table 9.30 Output Parameters**

Output Parameter Descriptions	Address	Data Format	Range	Type	User Program Access	For More Information
CV - Control Variable	User-defined	word (INT)	0 to 16,383	control	read/write	9-18
CV% - Output CV Percent	Word 16	word (INT)	0 to 100	control	read	9-19
OL - Output Limiting Enable	Word 0, Bit 3	binary	1 = enabled 0 = disabled	control	read/write	9-19
CVH - Output Maximum	Word 11	word (INT)	0 to 100%	control	read/write	9-20
CVL - Output Minimum	Word 12	word (INT)	0 to 100%	control	read/write	9-20

## Control Variable (CV)

**Table 9.31 Control Variable Parameter**

Output Parameter Descriptions	Address	Data Format	Range	Type	User Program Access
CV - Control Variable	User-defined	word (INT)	0 to 16,383	control	read/write

The CV (Control Variable) is user-defined. See the ladder rung below.

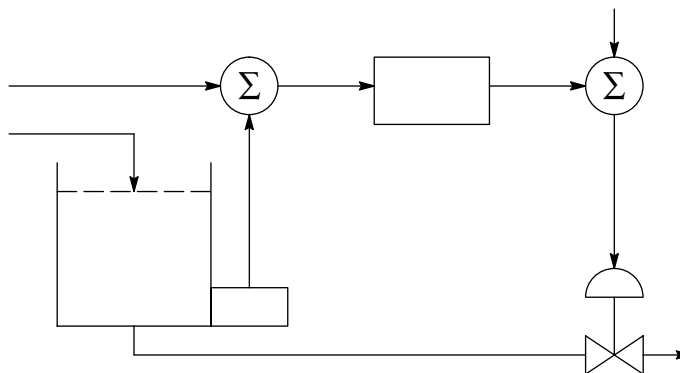

## Control Variable Percent (CV%)

**Table 9.32 Control Variable Percent Parameter**

<b>Output Parameter Descriptions</b>	<b>Address</b>	<b>Data Format</b>	<b>Range</b>	<b>Type</b>	<b>User Program Access</b>
CV% - Control Variable Percent	Word 16	word (INT)	0 to 100	status	read only

CV% (Control Variable Percent) displays the control variable as a percentage. The range is 0 to 100%. If the AM bit (word 0, bit 1 of the PID Control Block) is off (automatic mode), this value tracks the control variable (CV) output being calculated by the PID equation. If the AM bit is on (manual mode), this value tracks the value that can be manipulated in the control variable (CV) data word. If no change is made to the CV while in manual mode, the CV% will display the last value calculated by the PID equation.

## Output Limiting Enable (OL)

**Table 9.33 Output Limiting Enable Parameter**

<b>Output Parameter Descriptions</b>	<b>Address</b>	<b>Data Format</b>	<b>Range</b>	<b>Type</b>	<b>User Program Access</b>
OL - Output Limiting Enable	Word 0, Bit 3	binary	1 = enabled 0 = disabled	control	read/write

A value of one enables output limiting to the values defined in Control Variable Maximum (Word 11) and Control Variable Minimum (Word 12).

A value of zero disables OL (Output Limiting).

## Output Maximum (CVH)

**Table 9.34 Output Maximum Parameter**

<b>Output Parameter Descriptions</b>	<b>Address</b>	<b>Data Format</b>	<b>Range</b>	<b>Type</b>	<b>User Program Access</b>
CVH - Output Maximum	Word 11	word (INT)	0 to 100%	control	read/write

When the output limiting bit (OL) word 0, bit 3 of PID Control Block is enabled (1), the CVH (Control Value High) you enter is the maximum output (in percent) that the control variable attains. If the calculated CV exceeds the CVH, the CV is set (overridden) to the CVH value you entered and the upper limit alarm bit (UL) is set.

When the output limiting bit (OL) word 0, bit 3 of PID Control Block is disabled (0), the CVH value you enter determines when the upper limit alarm bit (UL) is set. If CV exceeds the maximum value, the output is not overridden and the upper limit alarm bit (UL) is set.

## Output Minimum (CVL)

**Table 9.35 Output Minimum Parameter**

<b>Output Parameter Descriptions</b>	<b>Address</b>	<b>Data Format</b>	<b>Range</b>	<b>Type</b>	<b>User Program Access</b>
CVL - Output Minimum	Word 12	word (INT)	0 to 100%	control	read/write

When the output limiting bit (OL) word 0, bit 3 of PID Control Block is enabled (1), the CVL (Control Value Low) you enter is the minimum output (in percent) that the Control Variable attains. If the calculated CV is below the minimum value, the CV is set (overridden) to the CVL value you entered and the lower limit alarm bit (LL) is set.

When the output limiting bit (OL) word 0, bit 3 of PID Control Block is disabled (0), the CVL value you enter determines when the lower limit alarm bit (LL) is set. If CV is below the minimum value, the output is not overridden and the lower limit alarm bit (LL) is set.



## Runtime Errors

Error code 0036 appears in the status file when a PID instruction runtime error occurs. Code 0036 covers the following PID error conditions, each of which has been assigned a unique single byte code value that appears in the MS byte of the second word of the control block.

**Table 9.36 PID Instruction Runtime Errors**

Error Code	Description of Error Condition or Conditions		Corrective Action	
11H	<i>SLC 5/02</i>	<i>SLC 5/03 and higher</i>	<i>SLC 5/02</i>	<i>SLC 5/03 and higher</i>
	1. Loop update time $D_t > 255$	1. Loop update time $D_t > 1024$	1. Change loop update time $D_t$ to $0 < D_t \leq 255$	Change loop update time $0 < D_t \leq 1024$
	2. Loop update time $D_t = 0$	2. Loop update time $D_t = 0$		
12H	<i>SLC 5/02</i>	<i>SLC 5/03 and higher</i>	<i>SLC 5/02</i>	<i>SLC 5/03 and higher</i>
	1. Proportional gain $K_c > 255$ , or	1. Proportional gain $K_c < 0$	Change proportional gain $K_c$ to $0 < K_c \leq 255$	Change proportional gain $K_c$ to $K_c \geq 0$
	2. Proportional gain $K_c = 0$			
13H	<i>SLC 5/02</i>	<i>SLC 5/03 and higher</i>	<i>SLC 5/02</i>	<i>SLC 5/03 and higher</i>
	Integral gain (reset) $T_i > 255$	Integral gain (reset) $T_i < 0$	Change integral gain (reset) $T_i$ to $0 \leq T_i \leq 255$	Change integral gain (reset) $T_i$ to $T_i \geq 0$
14H	<i>SLC 5/02</i>	<i>SLC 5/03 and higher</i>	<i>SLC 5/02</i>	<i>SLC 5/03 and higher</i>
	Derivative gain (rate) $T_d > 255$	Derivative gain (rate) $T_d < 0$	Change derivative gain (rate) $T_d$ to $0 \leq T_d \leq 255$	Change derivative gain (rate) $T_d$ to $T_d \geq 0$
21H (SLC 5/02 only)	1. Scaled setpoint max $S_{max} > 16383$ , or 2. Scaled setpoint max $S_{max} < -16383$		Change scaled setpoint max $S_{max}$ to $-16383 \leq S_{max} \leq 16383$	
22H (SLC 5/02 only)	1. Scaled setpoint min $S_{min} > 16383$ , or 2. Scaled setpoint min $S_{min} < -16383$		Change scaled setpoint min $S_{min}$ to $-16383 \leq S_{min} \leq S_{max} \leq 16383$	
23H	Scaled setpoint min $S_{min} > \text{Scaled setpoint max } S_{max}$		Change scaled setpoint min $S_{min}$ to $-16383 \leq S_{min} \leq S_{max} \leq 16383$ (SLC 5/03 and higher $-32768$ to $-82767$ )	
31H	<p>If you are using setpoint scaling and <math>S_{min} &gt; \text{setpoint } SP &gt; S_{max}</math>, or</p> <p>If you are not using setpoint scaling and <math>0 &gt; \text{setpoint } SP &gt; 16383</math>,</p> <p>then during the initial execution of the PID loop, this error occurs and bit 11 of word 0 of the control block is set. However, during subsequent execution of the PID loop if an invalid loop setpoint is entered, the PID loop continues to execute using the old setpoint, and bit 11 of word 0 of the control block is set.</p>		<p>If you are using setpoint scaling, then change the setpoint <math>SP</math> to <math>S_{min} \leq SP \leq S_{max}</math>, or</p> <p>If you are not using setpoint scaling, then change the setpoint <math>SP</math> to <math>0 \leq SP \leq 16383</math>.</p>	

**Table 9.36 PID Instruction Runtime Errors**

Error Code	Description of Error Condition or Conditions		Corrective Action	
<b>41H</b>	Scaling Selected	Scaling Deselected	Scaling Selected	Scaling Deselected
	1. <b>Deadband</b> < 0, or	1. <b>Deadband</b> < 0, or	Change <b>deadband</b> to $0 \leq \mathbf{deadband} \leq (\mathbf{Smax} - \mathbf{Smin}) \leq 16383$	Change <b>deadband</b> to $0 \leq \mathbf{deadband} \leq 16383$
	2. <b>Deadband</b> > ( <b>Smax - Smin</b> ), or	2. <b>Deadband</b> > 16383		
	3. <b>Deadband</b> > 16383 (5/02 specific)			
<b>51H</b>	1. <b>Output high limit</b> < 0, or 2. <b>Output high limit</b> > 100		Change <b>output high limit</b> to $0 \leq \mathbf{output\ high\ limit} \leq 100$	
<b>52H</b>	1. <b>Output low limit</b> < 0, or 2. <b>Output low limit</b> > 100		Change <b>output low limit</b> to $0 \leq \mathbf{output\ low\ limit} \leq \mathbf{output\ high\ limit} \leq 100$	
<b>53H</b>	<b>Output low limit</b> > <b>output high limit</b>		Change <b>output low limit</b> to $0 \leq \mathbf{output\ low\ limit} \leq \mathbf{output\ high\ limit} \leq 100$	
<b>60H</b>	<i>SLC 5/02</i> - PID is being entered for the second time. (PID loop was interrupted by an I/O interrupt, which is then interrupted by the PID STI interrupt.		You have at least three PID loops in your program: One in the main program or subroutine file, one in an I/O interrupt file, and one in the STI subroutine file. You must alter your ladder program and eliminate the potential nesting of PID loops.	

## PID and Analog I/O Scaling

For the SLC 500 PID instruction, the numerical scale for both the process variable (PV) and the control variable (CV) is 0 to 16383. To use engineering units, such as PSI or degrees, you must first scale your analog I/O ranges within the above numerical scale. To do this, use the Scale (SCL) instruction and follow the steps below.

1. Scale your analog input by calculating the slope (or rate) of the analog input range to the PV range (0 to 16383.) For example, an analog input with a range of 4 to 20mA has a decimal range of 3277 to 16384. The decimal range must be scaled across the range of 0 to 16383 for use as PV.
2. Scale the CV to span evenly across your analog output range. For example, an analog output which is scaled at 4 to 20mA has a decimal range of 6242 to 31208. In this case, 0 to 16383 must be scaled across the range of 6242 to 31208.

Once you have scaled your analog I/O ranges to/from the PID instruction, you can enter the minimum and maximum engineering units that apply to your application. For example, if the 4 to 20mA analog input range represents 0 to 300 PSI, you can enter 0 and 300 as the minimum (Smin) and maximum (Smax) parameters respectively. The Process Variable, Error, Setpoint, and Deadband are displayed in engineering units in the PID Data Monitor screen. Setpoint and Deadband can be entered into the PID instruction using engineering units.

The following equations show the linear relationship between the input value and the resulting scaled value.

$$\text{Scaled value} = (\text{input value} \times \text{slope}) + \text{offset}$$

$$\text{Slope} = (\text{scaled MAX.} - \text{scaled MIN.}) / (\text{input MAX.} - \text{input MIN.})$$

$$\text{Offset} = \text{scaled MIN.} - (\text{input MIN.} \times \text{slope})$$

## Using the SCL Instruction

Use the following values in an SCL instruction to scale common analog input ranges to PID process variables

**Table 9.37 SLC Instruction**

Parameter	4 to 20mA	0 to 5V	0 to 10V
Rate/10,000	12,499	10,000	5,000
Offset	-4096	0	0

Use the following values in an SCL instruction to scale control variables to common analog outputs.

**Table 9.38 SLC Instruction**

Parameter	4 to 20mA	0 to 5V	0 to 10V
Rate/10,000	15,239	10,000	19,999
Offset	6242	0	0

## Using the SCP Instruction

Use the following values in an SCP instruction to scale your analog inputs to the PV range and scale the CV range to your analog output

**Table 9.39 SCP Instruction**

Parameter	4 to 20mA	0 to 5V	0 to 10V
Input minimum	3277	0	0
Input maximum	16384	16384	32767
Scaled minimum	0	0	0
Scaled maximum	16383	16383	16383

Use the following values in an SCP instruction to scale control variables to common analog outputs.

**Table 9.40 SCP Instruction**

<b>Parameter</b>	<b>4 to 20mA</b>	<b>0 to 5V</b>	<b>0 to 10V</b>
Input minimum	0	0	0
Input maximum	16383	16383	16383
Scaled minimum	6242	0	0
Scaled maximum	31208	16384	32764

*Example*

The following ladder diagram shows a typical PID loop that is programmed in the STI mode. This example is provided primarily to show the proper scaling techniques. It shows a 4 to 20mA analog input and a 4 to 20mA analog output. The following parameters are:

- STI subroutine file (S:31) = 3.
- STI Setpoint (S:30) = 10.
- STI Enabled bit (S:2/1) = 1.

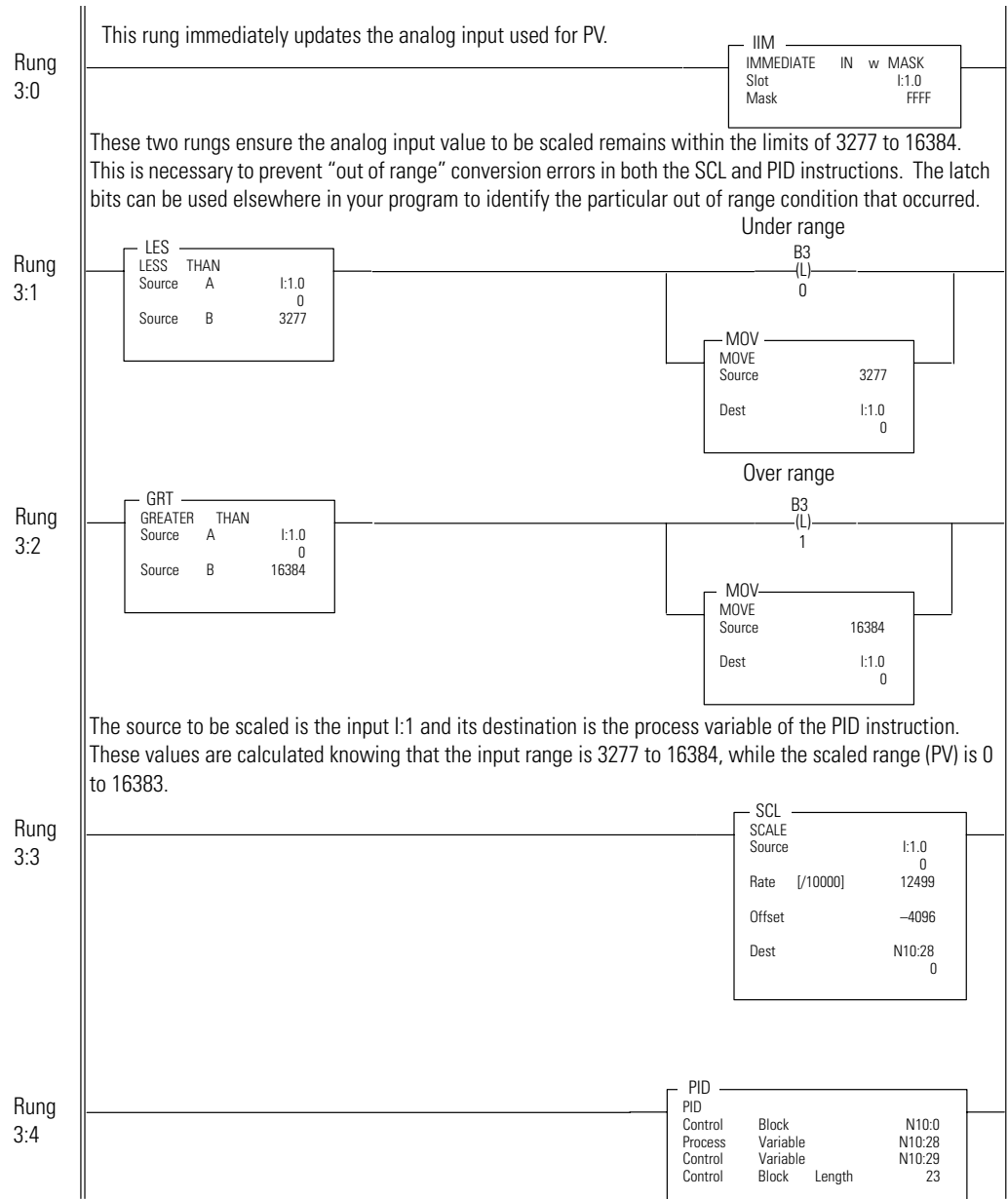

The STI routine should have a time interval equal to the setting of the PID “loop update” parameter.

## Application Notes

The following sections discuss:

- input/output ranges.
- scaling to engineering units.
- output alarms.
- output limiting with anti-reset windup.
- the manual mode.
- PID rung state.
- time proportioning outputs.

### Input/Output Ranges

The input module measuring the process variable (PV) must have a full scale binary range of 0 to 16383. If this value is less than 0 (bit 15 set), then a value of zero is used for PV and the Process var out of range bit is set (bit 12 of word 0 in the control block). If the process variable is >16383 (bit 14 set), then a value of 16383 is used for PV and the Process var out of range bit is set.

The Control Variable, calculated by the PID instruction, has the same range of 0 to 16383. The Control Output (word 16 of the control block) has the range of 0 to 100%. You can set lower and upper limits for the instruction's calculated output values (where an upper limit of 100% corresponds to a Control Variable limit of 16383).

### Scaling to Engineering Units

Scaling lets you enter the setpoint and zero-crossing deadband values in engineering units, and display the process variable and error values in the same engineering units. Remember, the process variable PV must still be within the range 0-16383. The PV is displayed in engineering units, however.

Select scaling as follows:

1. Enter the maximum and minimum scaling values  $S_{max}$  and  $S_{min}$  in the PID control block. Refer to the control block of the PID instruction on page 9-5. The  $S_{min}$  value corresponds to an analog value of zero for the lowest reading of the process variable, and  $S_{max}$  corresponds to an analog value of 16383 for the highest reading. These values reflect the process limits. Setpoint scaling is selected by entering a non-zero value for one or both parameters. If you enter the same value for both parameters, setpoint scaling is disabled.

For example, if measuring a full scale temperature range of  $-270^{\circ}\text{C}$  ( $\text{PV}=0$ ) to  $+1000^{\circ}\text{C}$  ( $\text{PV}=16383$ ), enter a value of  $-270$  for  $S_{\text{min}}$  and  $1000$  for  $S_{\text{max}}$ . Remember that inputs to the PID instruction must be  $0$  to  $16383$ . Signal conversions could be as follows:

**Table 9.41 Signal Conversions**

Parameter	Range
Process limits	$-270$ to $+1000^{\circ}\text{C}$
Transmitter output (if used)	$+4$ to $+20$ mA
Output of analog input module	$0$ to $16383$
PID instruction, $S_{\text{min}}$ to $S_{\text{max}}$	$-270$ to $+1000^{\circ}\text{C}$

- Enter the setpoint (word 2) and deadband (word 9) in the same scaled engineering units. Read the scaled process variable and scaled error in these units as well. The control output percentage (word 16) is displayed as a percentage of the  $0$  to  $16383$  CV range. The actual value transferred to the CV output is always between  $0$  and  $16383$ .

When you select scaling, the instruction scales the setpoint, deadband, process variable, and error. You must consider the effect on all these variables when you change scaling.

## Output Alarms

You may set an output alarm on the control output (CO) at a selected value above and/or below a selected output percent. When the instruction detects that the output (CO) has exceeded either value, it sets an alarm bit (bit 10 for lower limit, bit 9 for upper limit) in word 0 of the PID control block. Alarm bits are reset by the instruction when the output (CO) comes back inside the limits. The instruction does not prevent the output (CO) from exceeding the alarm values unless you select output limiting.

Select upper and lower output alarms by entering a value for the upper alarm (word 11) and lower alarm (word 12). Alarm values are specified as a percentage of the output. If you do not want alarms, enter zero and  $100\%$  respectively for lower and upper alarm values and ignore the alarm bits.



## Output Limiting with Anti-Reset Windup

You may set an output limit (percent of output) on the control output. When the instruction detects that the output (CO) has exceeded a limit, it sets an alarm bit (bit 10 for lower limit, bit 9 for upper limit) in word 0 of the PID control block, and prevents the output (CO) from exceeding either limit value. The instruction limits the output (CO) to 0 and 100% if you choose not to limit.

Select upper and lower output limits by setting the limit enable bit (bit 3 of control word 0), and entering an upper limit (word 11) and lower limit (word 12). Limit values are a percentage (0 to 100%) of the control output (CO).

The difference between selecting output alarms and output limits is that you must select output limiting to enable limiting. Limit and alarm values are stored in the same words. Entering these values enables the alarms, but not limiting. Entering these values and setting the limit enable bit enables limiting and alarms.

Anti-reset windup is a feature that prevents the integral term from becoming excessive when the output (CO) reaches a limit. When the sum of the PID and bias terms in the output (CO) reaches the limit, the instruction stops calculating the integral sum until the output (CO) comes back in range. The integral sum is contained in words 17 and 18 of the control block.

## The Manual Mode

In the manual mode, the PID algorithm does not compute the value of the control variable. Rather, it uses the value as an input to adjust the integral sum (words 17 and 18) so that a bumpless transfer takes place upon re-entering the AUTO mode.

To set the manual output level, design your ladder program to write to the CV address when in the manual mode. Note that this number is in the range of 0 to 16383, not 0 to 100. Writing to the CV percent (word 16) with your ladder program has no effect in the manual mode but adversely effects bumpless transfer.

The example on the next page shows how you can manually control the control variable (CV) output with your ladder program.

## PID Rungstate

If the PID rung is false, the integral sum (words 17 and 18) is cleared and CV remains in its last state.

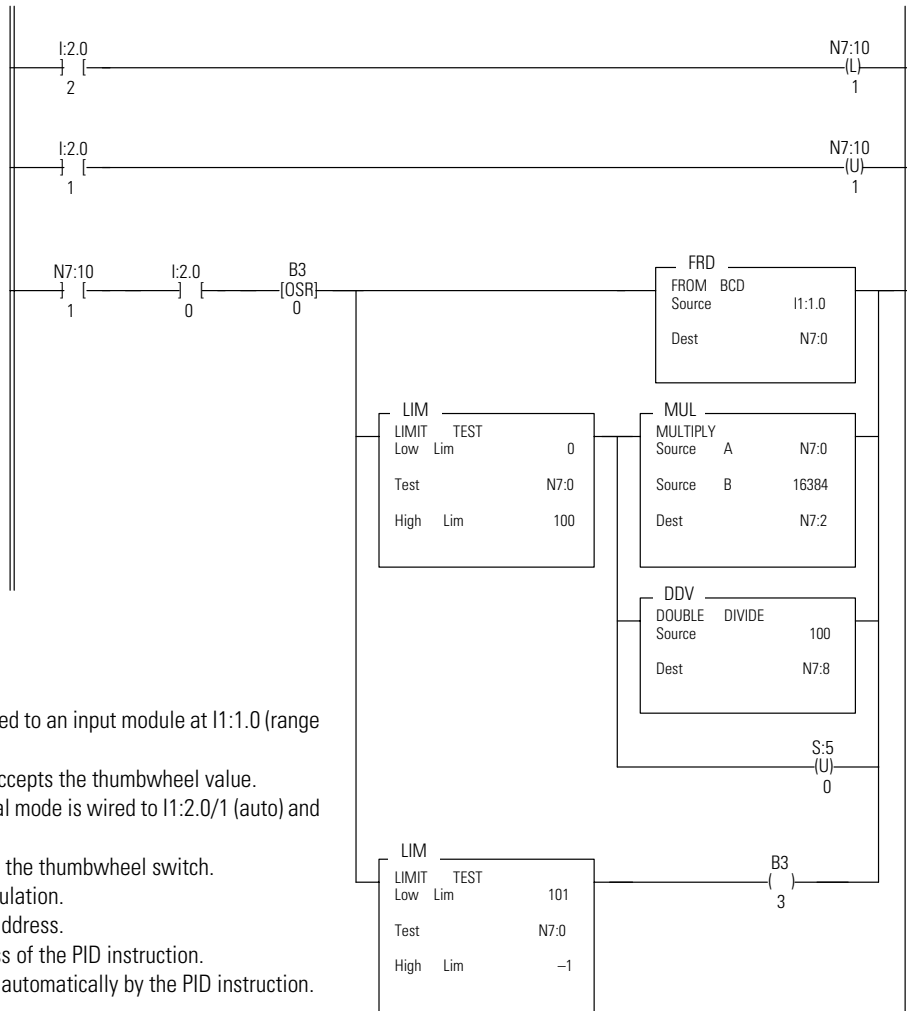

### Notes on Operation

- A 3-digit BCD thumbwheel is wired to an input module at I1:1.0 (range 0-100).
- A pushbutton wired to I1:2.0/0 accepts the thumbwheel value.
- A selector switch for auto/manual mode is wired to I1:2.0/1 (auto) and I1:2.0/2 (manual).
- N7:0 stores the value entered on the thumbwheel switch.
- N7:2 stores an intermediate calculation.
- N7:8 is the PID control variable address.
- N7:10 is the control block address of the PID instruction.
- N7:26 Percent output is updated automatically by the PID instruction.

## Time Proportioning Outputs

For heating or cooling applications, the Control Variable analog output is typically converted to a time-proportioning output. While this cannot be done directly with the processor, you can use the program on the following page to convert the Control Variable to a time proportioning output.

In this program, cycle time is the preset of timer T4:0. Cycle time relates to % on-time as follows:

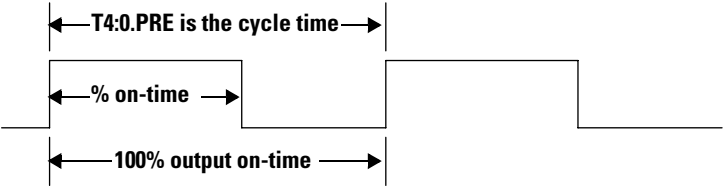

Example - Time proportioning outputs

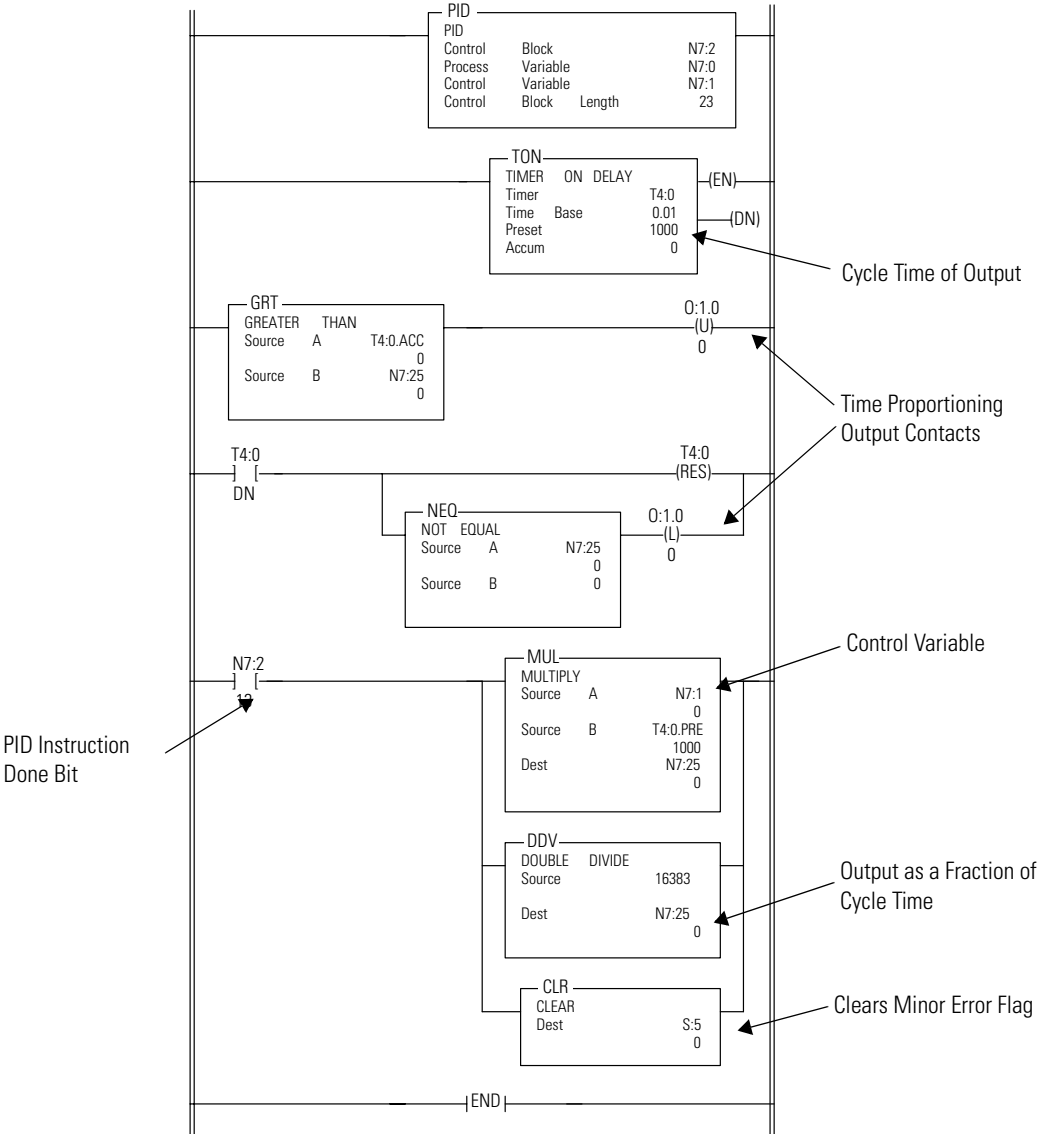

**Notes:**

## ASCII Instructions

This chapter contains general information about the ASCII instructions and explains how they function in your application program. Each of the instructions includes information on:

- what the instruction symbol looks like.
- how to use the instruction.

**Table 10.1 ASCII Instruction**

Instruction Mnemonic	Instruction Name	Purpose	Page
<b>ABL</b>	Test ASCII Buffer for Line	Determine the number of characters in the buffer, up to and including the user configured end of line character(s).	10-6
<b>ACB</b>	Number of ASCII Characters in Buffer	Determine the total number of characters in the buffer.	10-7
<b>ACI</b>	String to Integer	Convert a string to an integer value.	10-8
<b>ACL</b>	ASCII Clear Receive and/or Send Buffer	Clear the receive and/or transmit buffers.	10-9
<b>ACN</b>	String Concatenate	Link two strings into one.	10-11
<b>AEX</b>	String Extract	Extract a portion of a string to create a new string.	10-12
<b>AHL</b>	ASCII Handshake Lines	Set or reset modem handshake lines.	10-13
<b>AIC</b>	Integer to String	Convert an integer value to a string.	10-14
<b>ARD</b>	ASCII Read Characters	Read characters from the input buffer and place them into a string.	10-15
<b>ARL</b>	ASCII Read Line	Read one line of characters from the input buffer and place them into a string.	10-17
<b>ASC</b>	String Search	Search a string.	10-18
<b>ASR</b>	ASCII String Compare	Compare two strings.	10-19
<b>AWA</b>	ASCII Write with Append	Write a string with user-configured character(s) appended.	10-20
<b>AWT</b>	ASCII Write	Write a string.	10-22

## ASCII Instruction Overview

ASCII instructions are available in SLC 5/03 OS301 and above processors, and all SLC 5/04 and SLC 5/05 processors. There are two types of ASCII instructions.

- ASCII port control - these include instructions that use or alter the communication channel for receiving or transmitting data. When using these instructions, the system configuration for channel 0 must be set to “User Mode.”

(ABL, ACB, ACL\*, AHL\*, ARD, ARL, AWA\*, AWT\*)

\*may be executed in either user or system mode

ASCII port control instructions are queued in the order that they are scanned and are dependent on one another to execute (except ACL which executes immediately). For example, if you have an ARD (ASCII Read instruction) and then an AWT (ASCII Write instruction), the Done bit or the Error bit of the ARD must be set before the AWT can begin executing (even if the AWT was enabled while the processor was executing the ARD). A second ASCII port control instruction cannot begin executing until the first has completed. However, the processor does not wait for an ASCII port control instruction to complete before continuing to execute your ladder program.

- ASCII string control - these include instructions that manipulate string data. (ACI, ACN, AEX, AIC, ASC, ASR)

ASCII string control instructions execute immediately. They are never sent to the queue to wait their turn for execution.

## Protocol Parameter Overview

Listed below are the ASCII protocol parameters that you set via the Channel 0 configuration screens in your programming software.

**Table 10.2 ASCII Protocol Parameters**

Description	Specification
Baud Rate	Toggles between 110, 300, 600, 1.2K, 2.4K, 4.8K, 9.6K, and 19.2K (additional rate of 38.4K for SLC 5/04 and SLC 5/05 only). The default is 19.2K.
Start Bits	The default is 1 and cannot be changed.
Stop Bits	Options include 1, 1.5, and 2 The default is 1.
Parity	Toggles between None, Odd, and Even. The default is None.

**Table 10.2 ASCII Protocol Parameters**

Description	Specification
Data Bits	Toggles between 7 and 8. The default is 8.
Termination Characters	Allows you to configure up to 2 ASCII characters. The default is CR.
Append Characters	Allows you to configure up to 2 ASCII characters. The AWA instruction adds the characters to the end of every string to serve as termination characters for the receiving device. The default is CR LF.

*Using the ASCII Data File Type*

These are 1-word elements. Assign ASCII addresses as follows.

**Table 10.3 Addressing Format**

Format	Explanation		
<b>Af:e/b</b>	<b>A</b>	ASCII file	
	<b>f</b>	File number. A file number between 9 to 255 can be used.	
	:	Element delimiter	
	<b>e</b>	Element number	Ranges from 0 to 255. This is a 1-word element.
	/	Bit delimiter	
	<b>b</b>	Bit number	Bit location within the element. Ranges from 0 to 15.
<b>Examples</b>	A9:2	Element 2, ASCII file 9	
	A10:0/7	Bit 7, Element 0, ASCII file 10	

*Using the String (ST) Data File Type*

This file type is valid for SLC 5/03 OS301 and higher, SLC 5/04, and SLC 5/05 processors. These are 42-word elements. You can address string lengths by adding a .LEN to any string address (for example, ST17:1.LEN). Valid string data file numbers are 9 to 255.

String lengths must be between 0 and 82 bytes. In general, lengths that are outside of this range cause the processor to set the ASCII Error bit (S:5/15) and the instruction is not executed.

**TIP**

You can enter ASCII strings characters either directly into the ST file or as \ followed by the Hex value of the ASCII character. Refer to See Table 10.9 for more information.

**TIP**

You configure append or end-of-line characters via the Channel Configuration screen. The default append characters are carriage return and line feed; the default end-of-line (termination) character is a carriage return.

All instructions except ACL and AHL will error if the port is disabled.

Assign string addresses as follows.

**Table 10.4 Addressing Formats**

Format	Explanation		
<b>STf:e.s/b</b>	<b>ST</b>	String file	
	<b>f</b>	File number. A file number between 9 to 255 can be used.	
	<b>:</b>	Element delimiter	
	<b>e</b>	Element number	Ranges from 0 to 255. These are 42-word elements.
	<b>.</b>	Subelement delimiter	
	<b>s</b>	Subelement number	Ranges from 0 to 41. Word 0 is the length, .LEN. Words 1 to 41 are entered in as .DATA[0] to .DATA[40]
	<b>/</b>	Bit delimiter	
	<b>b</b>	Bit number	Bit location within the element. Ranges from 0 to 15.
<b>Examples</b>	ST9:2	Element 2, string file 9	
	ST9:2.LEN	Length, in bytes of element 2, string file 9	
	ST9:2.DATA[0]	Word 1 of element 2, string file 9	
	ST9:2.DATA[0]/15	Bit 15 of word 1 of element 2, string file 9	



## Entering Parameters

The control element for ASCII instructions includes eight status bits, an error code byte, and two character words.

**Table 10.5 ASCII Control Element**

	15	14	13	12	11	10	09	08	07	06	05	04	03	02	01	00
Word 0	EN	EU	DN	EM	ER	UL	IN	FD	Error Code							
Word 1	Number of Characters For Sending or Receiving (LEN)															
Word 2	Number of Characters Sent or Received (POS)															

EN = Enable Bit

EU = Queue Bit

DN = Asynchronous Done Bit

EM = Synchronous Done Bit

ER = Error Bit

UL = Unload Bit

IN = Running Bit (This is the IN Bit in the control data file [R6:].)

FD = Found Bit

- Found Bit FD (bit 8) indicates that the instruction found the end of line or termination characters in the buffer (applies to ABL and ACB instructions).
- Running Bit IN (bit 9) indicates that a queued instruction is executing.
- Unload Bit UL (bit 10) ceases instruction operation before (may be queued) or during execution. If this bit is set while an instruction is executing, any data already processed is sent to the destination. Note that the instruction is not removed from the queue; any remaining data is just not processed. You set this bit.
- Error Bit ER (bit 11) indicates that an error occurred while executing the instruction, such as a mode change via channel 1, or the instruction was cancelled using the UL bit or ACL instruction.
- Synchronous Done Bit EM (bit 12) is set concurrently to a program scan to indicate the completion of an ASCII instruction.
- Asynchronous Done Bit DN (bit 13) is set opposite to a program scan when an instruction successfully completes its operation. Note that an instruction can take longer than one program scan to finish executing.
- Queue Bit EU (bit 14) indicates that an ASCII instruction was placed in the ASCII queue. This action is delayed if the queue is already filled. The queue may contain up to 16 instructions.
- Enable Bit EN (bit 15) indicates that an instruction is enabled due to a false-to-true transition. This bit remains set until the instruction has completed executing or errors.

## Test ASCII Buffer for Line (ABL)

Use the ABL instruction to determine the total number of characters in the input buffer, up to and including the end-of-line characters (termination). This instruction looks for two termination characters that you configure via the ASCII port configuration screen. On a false-to-true transition, the processor reports the number of characters in the POS field of the ASCII control block. The serial port must be configured for User mode.

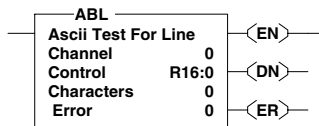

Fixed	SLC 5/01	SLC 5/02	SLC 5/03	SLC 5/04	SLC 5/05
			•	•	•

Output Instruction

### Entering Parameters

Enter the following parameters when programming this instruction.

- **Channel** is the number of the RS-232 port (Channel 0).
- **Control** is the area that stores the control register required to operate the instruction.
- **Characters** are the number of characters in the buffer that the processor finds (0-1024). This parameter is display only and resides in word 2 of the control block.
- **Error** displays the hexadecimal error code that indicates why the ER bit was set in the control data file (R6). See page 10-24 error code descriptions.

### Example

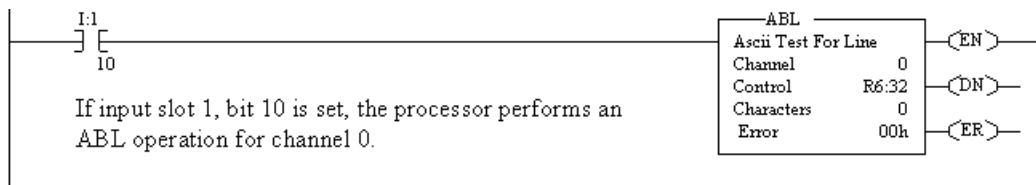

When the rung goes from false-to-true, the Enable bit (EN) is set. The instruction is put in the ASCII instruction queue, the Queue bit (EU) is set, and program scan continues. The instruction is then executed outside of the program scan. However, if the queue is empty the instruction executes immediately. Upon execution, the Running bit (IN) is set.

The processor determines the number of characters (up to and including the end-of-line/termination characters) and puts this value in the position field. The Done bit (DN) is then set.

If a zero appears in the POS field, no end-of-line/termination characters were found. The Found bit (FD) is set if the position field was set to a non-zero value.

When the program scans the instruction and finds the Done bit (DN) set, the processor then sets the Synchronous Done bit (EM). The EM bit acts as a secondary done bit corresponding to the program scan.

The Error bit (ER) is set during the execution of the instruction if:

- the instruction is aborted - serial port not in User mode.
- the instruction is aborted due to channel mode change.
- the Unload bit (UL) is set and the instruction is not executed.

## Number of ASCII Characters In Buffer (ACB)

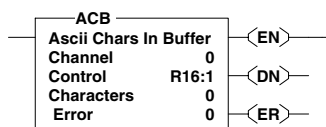

Fixed	SLC 5/01	SLC 5/02	SLC 5/03	SLC 5/04	SLC 5/05
			•	•	•

Output Instruction

Use the ACB instruction to determine the total characters in the buffer. On a false-to-true transition, the processor determines the total number of characters and records it in the position field of the ASCII control block. The serial port must be in User mode.

### Entering Parameters

Enter the following parameters when programming this instruction.

- **Channel** is the number of the RS-232 port (Channel 0).
- **Control** is the area that stores the control register required to operate the instruction.
- **Characters** are the number of characters in the buffer that the processor finds (0-1024). This parameter is display only.
- **Error** displays the hexadecimal error code that indicates why the ER bit was set in the control data file (R6). See page 10-24 for error descriptions.

### Example

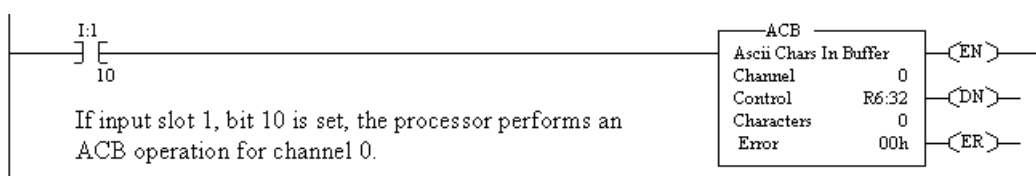

When the rung goes from false-to-true, the Enable bit (EN) is set. When the instruction is placed in the ASCII queue, the Queue bit (EU) is set. The Running bit (IN) is set when the instruction is executing. The Done bit (DN) is set upon completion of the instruction.

The processor determines the number of characters in the buffer and puts this value in the position field of the control block. The Done bit (DN) is then set. If a zero appears in the characters field, no characters were found.

When the program scans the instruction and finds the Done bit (DN) set, the processor then sets the Synchronous bit (EM). The EM bit acts as a secondary done bit corresponding to the program scan.

The Error bit (ER) is set during the execution of the instruction if:

- the instruction is aborted - serial port not in User mode.
- the instruction is aborted due to channel mode change.
- the Unload bit (UL) is set and the instruction is not executed.

## String to Integer (ACI)

Use the ACI instruction to convert a numeric ASCII string to an integer value between -32,768 and 32,767.

*Example*

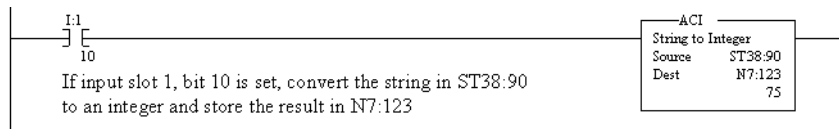
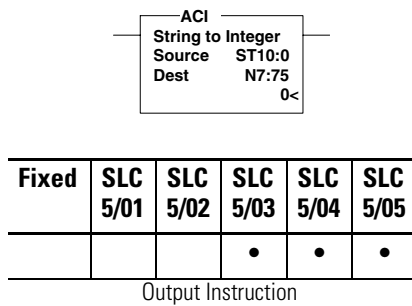

The processor searches the source (file type ST) for the first character between 0 and 9. All numeric characters are extracted until a non-numeric character or the end of the string is reached. Action is taken *only* if numeric characters are found. If the string contains an invalid length (<0 or >82) the ASCII Error bit S:5/15 is set. Commas and signs (+ -) are allowed in the string. However, only the minus sign is displayed in the data table.

The extracted numeric string is then converted to an integer. The ASCII Error bit S:5/15 is set if the string contains an invalid string length. The value of 32,767 is returned as the result.

This instruction also sets the arithmetic flags (found in word 0, bits 0-3 in the processor status file S:0).

**Table 10.6 Processor Function**

With this Bit	The Processor
S:0/0 Carry (C)	is reserved.
S:0/1 Overflow (V)	sets if the integer value is outside of the valid range.
S:0/2 Zero (Z)	sets if the integer value is zero.
S:0/3 Sign (S)	sets if the result is negative.

## ASCII Clear Receive and/or Transmit Buffer (ACL)

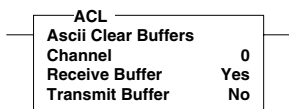

Fixed	SLC 5/01	SLC 5/02	SLC 5/03	SLC 5/04	SLC 5/05
			•	•	•

Output Instruction

Use this instruction to clear an ASCII buffer. ASCII instructions are removed from the queue and then the Error bit (ER) is set. This instruction clears the ASCII buffers immediately upon the rung transitioning to a true state. The instruction works when the channel is in User Mode or System Mode configured for DF1 Full-duplex or Half-duplex drivers. In System Mode, only the ASCII transmit buffer can be cleared.

For OS Series C, FRN 7 and higher, the ACL instruction can also be used to clear the DF1 communication buffers when the channel is configured for any of the DF1 communication drivers. Select 0 for the channel number and Yes for both the receive and transmit buffers. When the ACL instruction is executed, any pending outgoing DF1 replies, incoming DF1 commands, and outgoing DF1 commands are flushed. Any MSG instructions in progress on that channel will error out with an error code of 0x0C. The DF1 communication buffers are cleared at end-of-scan or during REF instruction execution.

### IMPORTANT

For OS Series C, FRN 7 and higher, when the ACL instruction is executed with both the Receive Buffer and Transmit buffer set to Yes while channel 0 is in System Mode and configured for DF1, two actions occur.

- The ASCII transmit buffer is cleared and any AWA and AWT instructions in the ASCII queue are removed.
- Any pending outgoing DF1 replies, incoming DF1 commands, and outgoing DF1 commands are flushed.

In addition, for SLC 5/03 processors with OS302 Series C, FRN 7 or higher, the ACL instruction can be used to clear the Local Passthru Queue when channel 0 is configured for DF1 and the DF1 Remote/Local Passthru bit (S:34/6) is set to Local. Select No for the receive buffer and Yes for the transmit buffer.

**IMPORTANT**

For SLC 5/03 with OS302, Series C, FRN 7 and higher, when the ACL instruction is executed with:

- the receive buffer set to No and the Transmit buffer set to Yes while channel 0 is in System Mode and configured for DF1.
- the DF1 Remote/Local Passthru bit is set for Local (S34/6=1).

Two actions occur.

- The ASCII transmit buffer is cleared and any AWA and AWT instructions in the ASCII queue are removed
- The Local Passthru queue is flushed

### Entering Parameters

Enter the following parameters when programming this instruction.

- **Channel** is the number of the RS-232 port (Channel 0).
- **Receive Buffer**, when set to Yes, clears the receive buffer and removes the ARD and ARL instructions from the queue. The Error bit (ER) is set in each of these instructions.
- **Transmit Buffer**, when set to Yes, clears the transmit buffer and removes the AWA and AWT instructions from the queue. The Error bit (ER) is set in each of these instructions.

*Example*

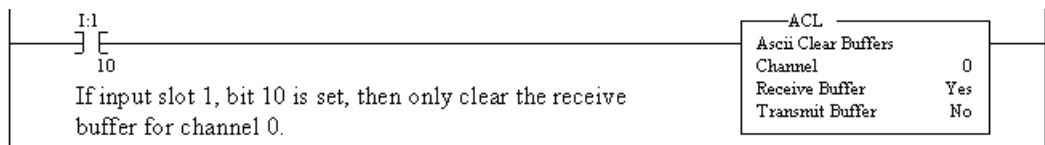

When the rung goes true, the selected buffer(s) will be cleared and the ASCII instruction(s) are removed from the ASCII instruction queue.

## String Concatenate (ACN)

The ACN instruction combines two strings using ASCII strings as operands. The second string is appended to the first and the result stored in the destination.

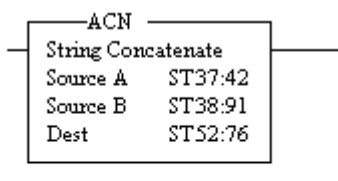

### Entering Parameters

Enter the following parameters when programming this instruction.

- **Source A** is the first string in the concatenation procedure.
- **Source B** is the second string in the concatenation procedure.
- **Destination** is where the result of Source A and B is stored.

Fixed	SLC 5/01	SLC 5/02	SLC 5/03	SLC 5/04	SLC 5/05
			•	•	•

Output Instruction

### Example

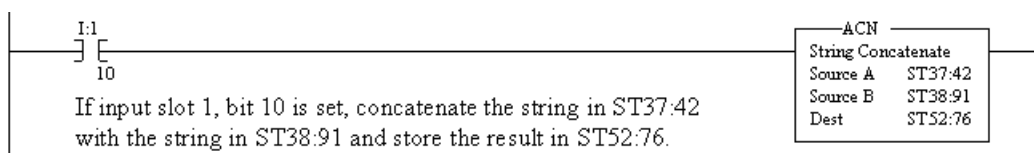

Only the first 82 characters (0 to 81) are written to the destination. If the result is > 82 the ASCII Error bit S:5/15 is set.

## String Extract (AEX)

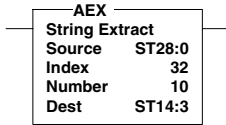

Fixed	SLC 5/01	SLC 5/02	SLC 5/03	SLC 5/04	SLC 5/05
			•	•	•

Output Instruction

Use the AEX instruction to create a new string by taking a portion of an existing string and linking it to a new string.

### Entering Parameters

Enter the following parameters when programming this instruction.

- **Source** is the existing string. The source value is not affected by this instruction.
- **Index** is the starting position (from 1 to 82) of the string you want to extract. (An index of 1 indicates the left-most character of the string.)
- **Number** is the number of characters (from 1 to 82) you want to extract, starting at the indexed position. If the index plus the number is greater than the total characters in the source string, the destination string will be the characters from the index to the end of the source string.
- **Destination** is the string element (ST) where you want the extracted string stored.

### Example

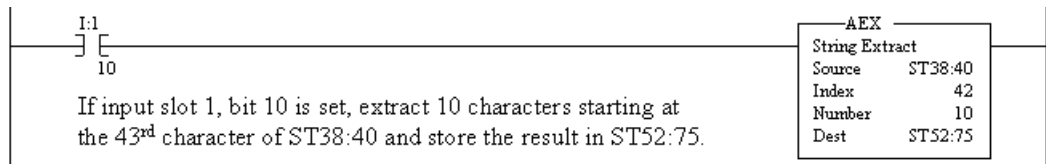

The following conditions cause the processor to set the ASCII Error bit (S:5/15).

- Invalid source string length or string length of zero
- Index or number values outside of range
- Index value greater than the length of the source string

The destination string is not changed in any of the above error conditions. However, the destination will be changed if the index value plus the number value are greater than the string length. Note that the ASCII Error bit (S:5/15) is not set.



## ASCII Handshake Lines (AHL)

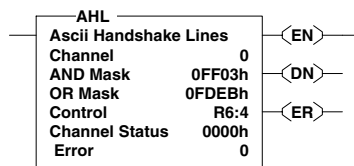

Fixed	SLC 5/01	SLC 5/02	SLC 5/03	SLC 5/04	SLC 5/05
			•	•	•

Output Instruction

Use the AHL instruction to set or reset the RS-232 Data Terminal Ready (DTR) and Request to Send (RTS) handshake control lines for your modem. On a false-to-true transition, the processor uses the two masks to determine whether to set or reset the DTR and RTS lines, or leave them unchanged. This instruction will operate when the port is in either mode or is disabled.

### TIP

Make sure the automatic modem control used by the port, in system mode, does not conflict with this instruction.

## Entering Parameters

Enter the following parameters when programming this instruction.

- **Channel** is the number of the RS-232 port (Channel 0).
- **AND Mask** is the type of mask used to reset the DTR and RTS control lines. Bit 0 corresponds to the DTR line and bit 1 corresponds to the RTS control line. A 1 at the mask bit causes the line to be reset; a 0 leaves the line unchanged. Note that mask values do not have a one-to-one correspondence to the modem control lines.
- **OR Mask** is the type of mask used to set the DTR and RTS control lines. Bit 0 corresponds to the DTR line and bit 1 corresponds to the RTS control line. A 1 at the mask bit causes the line to be set; a 0 leaves the line unchanged. Note that mask values do not have a one-to-one correspondence to the modem control lines.
- **Control** is the area that stores the control register required to operate the instruction.
- **Channel Status** displays the current status (0000 to 001F) of the handshake lines for the channel, specified above. This field is display only and resides in word 2 of the control element.
- **Error** displays the hexadecimal error code that indicates why the ER bit was set in the control data file (R6). See page 10-24 for error code descriptions.

*Example*

The following shows the channel status as 001F.

**Table 10.7 Control Block Structure**

Channel Status Bit	15	14	13	12	11	10	9	8	7	6	5	4	3	2	1	0
Bit	Reserved											DTR	DCD	DSR	RTS	CTS
Line	0	0	0	0	0	0	0	0	0	0	0	1	1	1	1	1
Channel Status	0				0				1				F			

*Example*

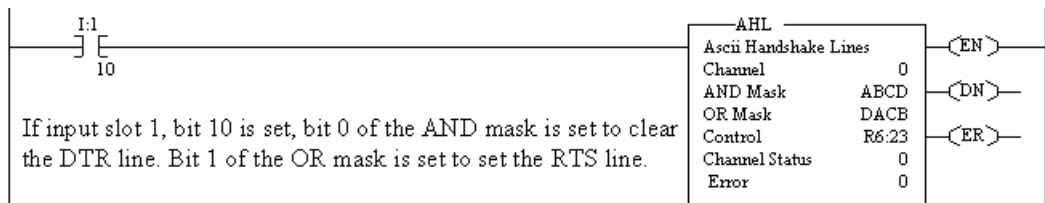

The Error bit (ER) is set during the execution of the instruction if:

- the instruction is aborted due to channel mode change.
- the Unload bit (UL) is set and the instruction is not executed.

**Integer to String (AIC)**

The AIC instruction converts an integer value (-32,768 and 32,767) to an ASCII string. The source can be a constant or an integer address.

*Example*

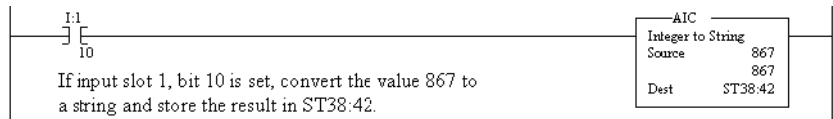
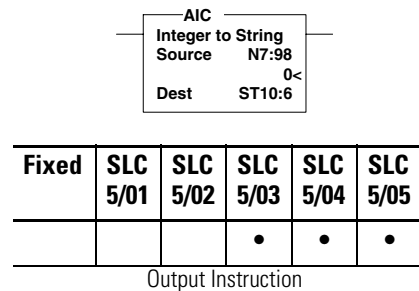

## ASCII Read Characters (ARD)

Use the ARD instruction to read characters from the buffer and store them in a string. To repeat the operation, the rung must go from false-to-true.

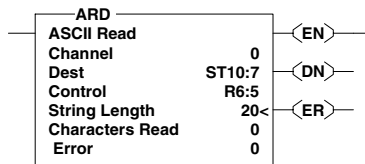

Fixed	SLC 5/01	SLC 5/02	SLC 5/03	SLC 5/04	SLC 5/05
			•	•	•

Output Instruction

### Entering Parameters

Enter the following parameters when programming this instruction.

- **Channel** is the number of the RS-232 port (Channel 0).
- **Destination** is the string element where you want the characters stored.
- **Control** is the address of the control block used to store data for the ARD instruction.
- **String Length (.LEN)** is the number of characters you want to read from the buffer. The maximum is 82 characters. If you specify a length larger than 82, only the first 82 characters will be read. (A 0 defaults to 82.) This is word 1 in the control block.
- **Characters Read (.POS)** are the number of characters that the processor moved from the buffer to the string (0 to 82). This field is updated during the execution of the instruction and is display only. This is word 2 in the control block.
- **Error** displays the hexadecimal error code that indicates why the ER bit was set in the control data file (R6). See page 10-24 for error code descriptions.

### Example

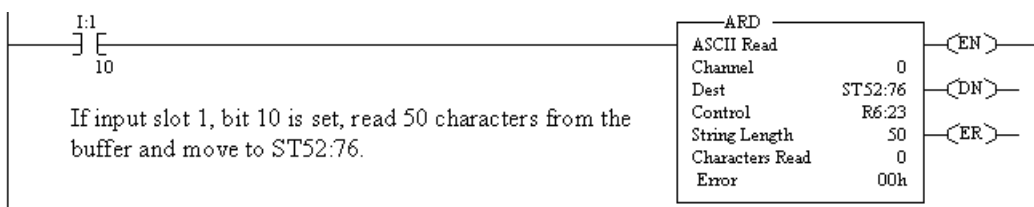

When the rung goes from false-to-true, the Enable bit (EN) is set. When the instruction is placed in the ASCII queue, the Queue bit (EU) is set. The Running bit (IN) is set when the instruction is executing. The DN bit is set upon completion of the instruction.

Once the requested number of characters are in the buffer, the characters are moved to the destination string. The number of characters moved is put in the POS field of the control block. The number in the Characters Read field is continuously updated and the Done bit (DN) is not set until all of the characters are read.

When the program scans the instruction and finds the Done bit (DN) set, the processor then sets the Synchronous Done bit (EM). The EM bit acts as a secondary done bit corresponding to the program scan.

The Error bit (ER) is set during the execution of the instruction if:

- the instruction is aborted - serial port is not in User mode.
- the modem is disconnected (control line selection is other than NO HANDSHAKING).
- the instruction is aborted due to channel mode change.
- the Unload bit (UL) is set. The instruction stops executing, but received characters are sent to the destination.
- an ACL to clear the receive buffer is executed, removing the ARD instruction from the ASCII queue.

### Timing Diagram for a Successful ARD, ARL, AWA, and AWT Instructions

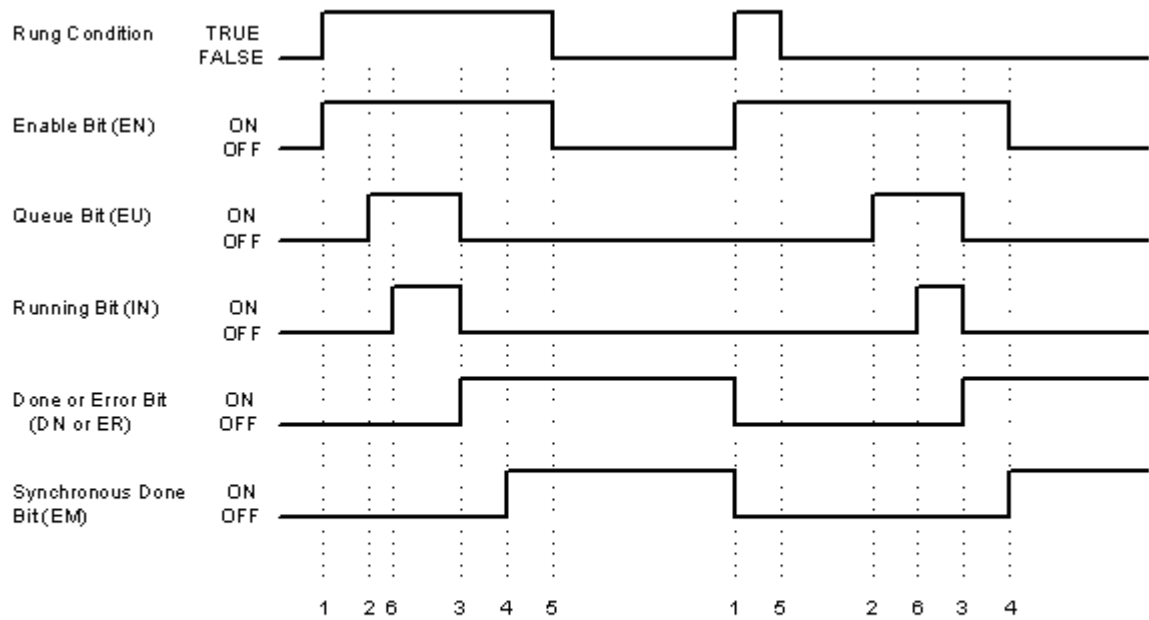

- 1 - Rung Goes True
- 2 - Instruction Successfully Queued
- 3 - Instruction Execution Complete
- 4 - Instruction Scanned for the First Time After Execution is Complete
- 5 - Rung Goes False
- 6 - Either the Instruction is not in the Queue or it is Being Executed

## ASCII Read Line (ARL)

Use the ARL instruction to read characters from the buffer, up to and including the end-of-line (termination) characters, and store them in a string. The end-of-line characters are specified via the ASCII Configuration screen.

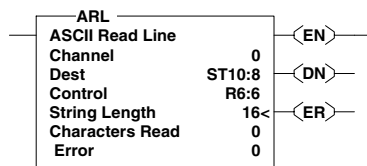

### Entering Parameters

Enter the following parameters when programming this instruction.

- **Channel** is the number of the RS-232 port (Channel 0).
- **Destination** is the string element where you want the characters stored.
- **Control** is the address of the control block used to store data for the ARL instruction.
- **String Length (LEN)** is the number of characters you want to read from the buffer. The maximum is 82 characters. If you specify a length larger than 82, only the first 82 characters are read and moved to the destination. (A 0 defaults to 82.) This is word 1 in the control block.
- **Characters Read (POS)** are the number of characters that the processor moved from the buffer to the string (0 to 82). This field is display only and resides in word 2 of the control block.
- **Error** displays the hexadecimal error code that indicates why the ER bit was set in the control data file (R6). See page 10-24 for error code descriptions.

Fixed	SLC 5/01	SLC 5/02	SLC 5/03	SLC 5/04	SLC 5/05
			•	•	•

Output Instruction

### Example

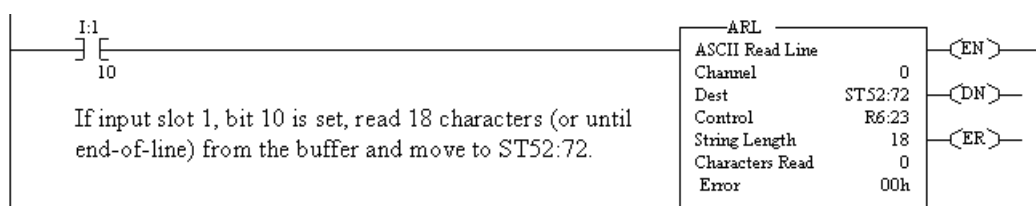

When the rung goes from false-to-true, the control element Enable (EN) bit is set. When the instruction is placed in the ASCII queue, the Queue bit (EU) is set. The Running bit (IN) is set when the instruction is executing. The DN bit is set upon completion of the instruction.

Once either the end of line character(s) are received or, the requested number of characters are in the buffer, all characters (including the end-of-line characters) are moved to the destination string. The number of characters moved is stored in the POS word of the control block. The number in the Characters Read field is continuously updated and the Done bit (DN) is not set until either the end of line character(s) are received or, all of the characters have been read.

When the program scans the instruction and finds the Done bit (DN) set, the processor then sets the Synchronous bit (EM). The EM bit acts as a secondary done bit corresponding to the program scan.

The Error bit (ER) is set during the execution of the instruction if:

- the instruction is aborted - serial port is not in User mode.
- the modem is disconnected (when control line selection is other than “NO HANDSHAKING”).
- the instruction is aborted due to channel mode change.
- the Unload bit (UL) is set. The instruction stops executing, but received characters are sent to the destination.
- an ACL to clear the receive buffer is executed, removing the ARL instruction from the ASCII queue.

**TIP** For information on the timing of this instruction, refer to the timing diagram on page 10-16.

## String Search (ASC)

Use the ASC instruction to search an existing string for an occurrence of the source string.

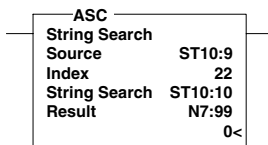

Fixed	SLC 5/01	SLC 5/02	SLC 5/03	SLC 5/04	SLC 5/05
			•	•	•

Output Instruction

### Entering Parameters

Enter the following parameters when programming this instructio.:

- **Source** is the string you want to find when examining the search string.
- **Index** is the starting position (from 1 to 82) of the portion of the string you want to find. (An index of 1 indicates the left-most character of the string.)
- **String Search** is the string you want to examine.
- **Result** is an integer where the processor stores the position of the search string where the source string begins. If no match is found, result is set equal to zero.

### Example

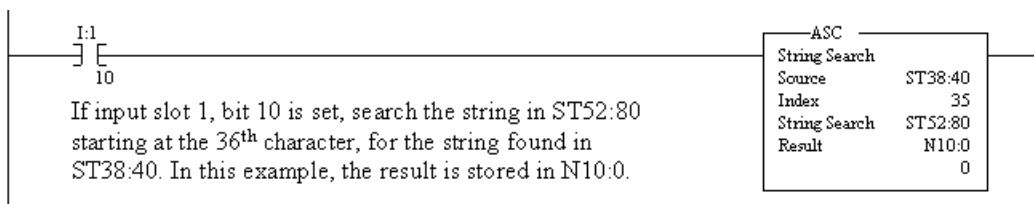

The following conditions cause the processor to set the ASCII Error bit (S:5/15).

- Invalid string length or string length of zero
- Index value outside of range
- Index value greater than the length of the source string

The destination is not changed in any of the above conditions.

## ASCII String Compare (ASR)

Use the ASR instruction to compare two ASCII strings. The system looks for a match in length and upper/lower case characters. If two strings are identical, the rung is true; if there are any differences, the rung is false.

### Entering Parameters

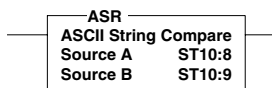

Enter the following parameters when programming this instruction.

Fixed	SLC 5/01	SLC 5/02	SLC 5/03	SLC 5/04	SLC 5/05
			•	•	•

Input Instruction

- **Source A** is string one for comparison.
- **Source B** is string two for comparison.

### Example

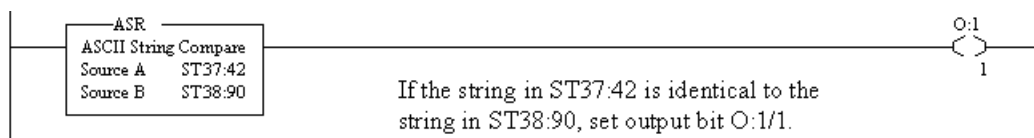

An invalid string length causes the processor to set ASCII Error bit S:5/15, and the rung goes false.

## ASCII Write with Append (AWA)

Use the AWA instruction to write characters from a source string to an external device. This instruction adds the one or two appended characters that you configure on the ASCII Configuration screen. The default is a carriage return and line feed appended to the end of the string. When using this instruction you can also perform in-line indirection. See page 10-21 for more information.

### Entering Parameters

Enter the following parameters when programming this instruction.

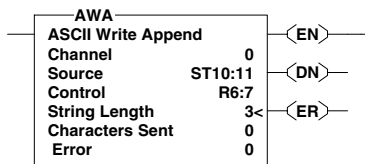

Fixed	SLC 5/01	SLC 5/02	SLC 5/03	SLC 5/04	SLC 5/05
			•	•	•

Output Instruction

- **Channel** is the number of the RS-232 port (Channel 0).
- **Source** is the string element you want to write.
- **Control** is the area that stores the control register required to operate the instruction.
- **String Length (.LEN)** is the number of characters you want to write from the source string (0 to 82). If you enter a 0, the entire string will be written. This is word 1 in the control block.
- **Characters Sent (.POS)** are the number of characters that the processor sent to the display area (0 to 82). This field is continuously updated during the execution of the instruction. This value can be greater than the string length if appended characters or inserted values from in-line indirection are used. If the string length is greater than 82, the string written to the destination is truncated to 82 characters. This is word 2 in the control block.
- **Error** displays the hexadecimal error code that indicates why the ER bit was set in the control data file (R6). See page 10-24 for error code descriptions.

### Example

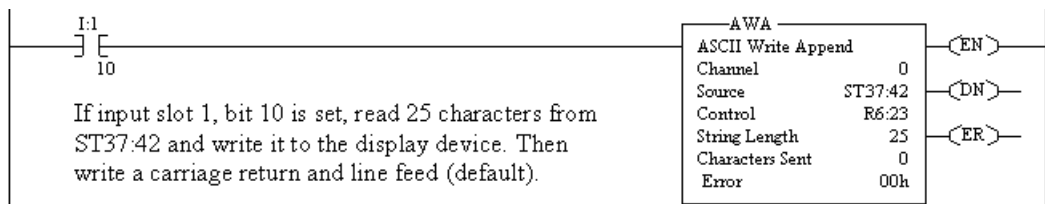

When the rung goes from false-to-true, the control element Enable (EN) bit is set. When the instruction is placed in the ASCII queue, the Queue bit (EU) is set. The Running bit (IN) is set when the instruction is executing. The DN bit is set on completion of the instruction.

The system sends 25 characters from the start of string ST37:42 to the display device and then sends user-configured append characters. The Done bit (DN) is set and a value of 27 is present in .POS word of the ASCII control block.



When the program scans the instruction and finds the Done bit (DN) set, the processor then sets the Synchronous Done bit (EM) to act as a secondary done bit corresponding to the program scan.

The Error bit (ER) is set during execution of the instruction if:

- the modem is disconnected (control line selection is other than NO HANDSHAKING).
- port is in System Mode and is configured for DH-485 or DF1 Radio Modem.
- the Unload bit (UL) is set. The instruction stops executing, but received characters are sent to the destination.
- an ACL to clear the send buffer is executed, removing the AWA instruction from the ASCII queue.

**TIP**

For information on the timing of this instruction, refer to the timing diagram on page 10-16.

## Using Inline Indirection

This allows you to insert integer and floating point values into ASCII strings. The Running bit (IN) must be set before the string value can be used.

The following conditions apply to performing in-line indirection.

- All valid integer (N) and floating point (F) files can be used. Valid ranges include 7, 8, and 9-255
- file types are not case sensitive and can include either a colon (:) or semicolon (;)
- positive values and leading zeros are not printed. Negative values are printed with a leading minus sign

### Examples

For the following examples:

N7:0 = 250  
 N7:1 = -37  
 F8:0 = 2.015000  
 F8:1 = 0.873000

Valid in-line direction:	
Input:	Flow rate is currently [N7:0] GPH and contains [F8:0] PPM contaminants.
Output:	Flow rate is currently 250 GPH and contains 2.015000 PPM contaminants.
Input:	Current position is [N7:1] at a speed of [F8:1] RPM.
Output:	Current position is -37 at a speed of 0.873000 RPM.
Invalid in-line indirection:	
Input:	Current position is [N5:1] at a speed of [F8:1] RPM.
Output:	Current position is [N5:1] at a speed of 0.873000 RPM.

**TIP** Truncation occurs in the output string if the indirection causes the output to exceed 80 characters. The appended characters are always applied to the output.

## ASCII Write (AWT)

Use the AWT instruction to write characters from a source string to an external device. To repeat the instruction, the rung must go from false-to-true. When using this instruction you can also perform in-line indirection. See page 10-21 for more information.

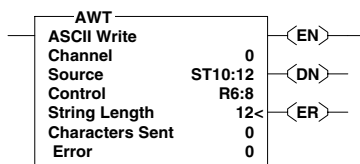

### Entering Parameters

Enter the following parameters when programming this instruction.

- **Channel** is the number of the RS-232 port (Channel 0).
- **Source** is the string element you want to write.
- **Control** is the area that stores the control register required to operate the instruction.
- **String Length (LEN)** is the number of characters you want to write from the source string (0 to 82). If you enter a 0, the entire string will be written.

Fixed	SLC 5/01	SLC 5/02	SLC 5/03	SLC 5/04	SLC 5/05
			•	•	•

Output Instruction

- **Characters Sent** (POS) is the number of characters that the processor sent to the display area (0 to 82). Only after the entire string is sent is this field updated (no running total for each character is stored). This field is display only. This value can be greater than the string length if inserted values from in-line indirection are used. If the string length is greater than 82, the string written to the destination is truncated to 82 characters.
- **Error** displays the hexadecimal error code that indicates why the ER bit was set in the control data file (R6). See page 10-24 for error code descriptions.

### Example

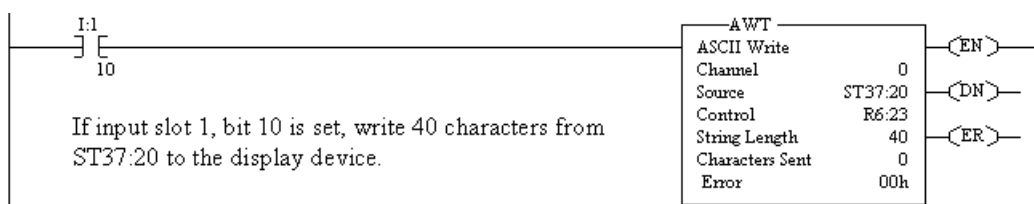

When the rung goes from false-to-true, the control element Enable (EN) bit is set. When the instruction is placed in the ASCII queue, the Queue bit (EU) is set. The Running bit (IN) is set when the instruction is executing. The DN bit is set on completion of the instruction.

Forty characters from string ST37:40 are sent through channel 0. The Done bit (DN) is set and a value of 40 is present in the POS word of the ASCII control block.

When the program scans the instruction and finds the Done bit (DN) set, the processor then sets the Synchronous Done bit (EM) to act as a secondary done bit corresponding to the program scan.

The Error bit (ER) is set during execution of the instruction if:

- the modem is disconnected (control line selection is other than “NO HANDSHAKING”).
- port is in System Mode and is configured for DH-485 or DF1 Radio Modem.
- the Unload bit (UL) is set. The instruction stops executing, but received characters are sent to the destination.
- an ACL to clear the transmit buffer is executed, removing the AWT instruction from the ASCII queue.

### TIP

For information on the timing of this instruction, refer to the timing diagram on page 10-16.

## ASCII Instruction Error Codes

The following error codes indicate why the Error bit (ER) is set in the control data file (R6).

**Table 10.8 ASCII Error Codes**

<b>Error Code (HEX)</b>	<b>Conditions Resulting in the Setting of the ER Bit</b>	<b>Recommended Action</b>
00	No error. The instruction completed successfully.	None required.
02	Operation cannot be completed because the modem went offline.	Check modem cabling to communication channel. If the channel is configured for modem handshaking, both the DCD (Data-Carrier-Detect) and DSR (Data-Set-Ready) lines to the channel must be active for the modem to be online.
03	Transmission cannot be completed because the Clear-to-Send signal was lost.	Check modem and modem cabling connections.
04	Cannot perform ASCII receives because the communication channel is configured for System Mode.	Reconfigure the communication channel for User Mode.
05	While attempting to perform ASCII transmission, System Mode (DF1) communication was detected.	Verify that the modem is online and communicating with required devices.
07	Cannot perform ASCII send or receive because channel configuration has been shut down via the channel configuration menu.	Reconfigure the channel configuration menu and retry operation.
08	Cannot perform ASCII write due to an ASCII transmission already in progress.	Resend the transmission.
09	ASCII communication requested is not supported by current channel configuration. (Channel 0 is configured for DH-485 or DF1 Radio Modem while trying to initiate an ASCII transmission or modem handshake control.)	Configure channel 0 for DF1 Full-duplex, DF1 Half-duplex Master, or DF1 Half-duplex Slave.
0A	The Unload bit (UL) was set, stopping instruction execution.	None required.
0B	The requested length for the string is either a negative number or greater than 82. Applies to ARD and ARL instructions.	Enter a valid string length and retry operation.
0C	The length of the source string is either a negative number or greater than 82. Applies to AWA and AWT instructions.	Enter a valid string length and retry operation.
0D	The requested length (.LEN) in the control block is a negative number or a value greater than 82. Applies to AWA and AWT instructions.	Enter a valid length and retry operation.
0E	The ACL instruction was aborted.	None required.
0F	The channel configuration mode was changed.	None required.

## ASCII Conversion Table

The table below lists the decimal, hexadecimal, and ASCII conversions.

**Table 10.9 ASCII Conversion Table**

ASCII	Hex	Decimal	Enter as	Displayed as
NUL	00	0	\00	\00
SOH	01	1	^A or ^a or \01	^A
STX	02	2	^B or ^b or \02	^B
ETX	03	3	^C or ^c or \03	^C
EOT	04	4	^D or ^d or \04	^D
ENQ	05	5	^E or ^e or \05	^E
ACK	06	6	^F or ^f or \06	^F
BEL	07	7	^G or ^g or \07	^G
BS	08	8	^H or ^h or \08	^H
HT	09	9	^I or ^i or \09	^I
LF	0A	10	^J or ^j or \0A or \0a	^J
VT	0B	11	^K or ^k or \0B or \0b	^K
FF	0C	12	^L or ^l or \0C or \0c	^L
CR	0D	13	^M or ^m or \0D or \0d	^M
SOH	0E	14	^N or ^n or \0E or \0e	^N
SI	0F	15	^O or ^o or \0F or \0f	^O
DLE	10	16	^P or ^p or \10	^P
DC1	11	17	^Q or ^q or \11	^Q
DC2	12	18	^R or ^r or \12	^R
DC3	13	19	^S or ^s or \13	^S
DC4	14	20	^T or ^t or \14	^T
HAK	15	21	^U or ^u or \15	^U
SYN	16	22	^V or ^v or \16	^V
ETB	17	23	^W or ^w or \17	^W
CAN	18	24	^X or ^x or \18	^X
EM	19	25	^Y or ^y or \19	^Y
SUB	1A	26	^Z or ^z or \1A or \1a	^Z
ESC	1B	27	\1B or \1b	\1B
FS	1C	28	\1C or \1c	\1C
GS	1D	29	\1D or \1d	\1D
RS	1E	30	\1E or \1e	\1E
US	1F	31	\1F or \1f	\1F
SP	20	32	\20	

**Table 10.9 ASCII Conversion Table (Continued)**

<b>ASCII</b>	<b>Hex</b>	<b>Decimal</b>	<b>Enter as</b>	<b>Displayed as</b>
!	21	33	! or \21	!
""""	22	34	"""" or \22"	""""
#	23	35	# or \23	#
\$	24	36	\$ or \24	\$
%	25	37	% or \25	%
&	26	38	& or \26	&
'	27	39	' or \27	'
(	28	40	( or \28	(
)	29	41	) or \29	)
*	2A	42	* or \2A or \2a	*
+	2B	43	+ or \2B or \2b	+
,	2C	44	, or \2C or \2c	,
-	2D	45	- or \2D or \2d	-
.	2E	46	. or \2E or \2e	.
/	2F	47	/ or \2F or \2f	/
0	30	48	0 or \30	0
1	31	49	1 or \31	1
2	32	50	2 or \32	2
3	33	51	3 or \33	3
4	34	52	4 or \34	4
5	35	53	5 or \35	5
6	36	54	6 or \36	6
7	37	55	7 or \37	7
8	38	56	8 or \38	8
9	39	57	9 or \39	9
:	3A	58	: or \3A or \3a	:
;	3B	59	; or \3B or \3b	;
<	3C	60	< or \3C or \3c	<
=	3D	61	= or \3D or \3d	=
>	3E	62	> or \3E or \3e	>
?	3F	63	? or \3F or \3f	?
@	40	64	@ or \40	@
A	41	65	A or \41	A
B	42	66	B or \42	B
C	43	67	C or \43	C
D	44	68	D or \44	D

Table 10.9 ASCII Conversion Table (Continued)

ASCII	Hex	Decimal	Enter as	Displayed as
E	45	69	E or \45	E
F	46	70	F or \46	F
G	47	71	G or \47	G
H	48	72	H or \48	H
I	49	73	I or \49	I
J	4A	74	J or \4A or \4a	J
K	4B	75	K or \4B or \4b	K
L	4C	76	L or \4C or \4c	L
M	4D	77	M or \4D or \4d	M
N	4E	78	N or \4E or \4e	N
O	4F	79	O or \4F or \4f	O
P	50	80	P or \50	P
Q	51	81	Q or \51	Q
R	52	82	R or \52	R
S	53	83	S or \53	S
T	54	84	T or \54	T
U	55	85	U or \55	U
V	56	86	V or \56	V
W	57	87	W or \57	W
X	58	88	X or \58	X
Y	59	89	Y or \59	Y
Z	5A	90	Z or \5A or \5a	Z
[	5B	91	[ or \5B or \5b	[
\	5C	92	\ or \5C or \5c	\
]	5D	93	] or \5D or \5d	]
^	5E	94	\^ or \5E or \5e	\^
_	5F	95	\_ or \5F or \5f	\_
'	60	96	' or \60	'
a	61	97	a or \61	a
b	62	98	b or \62	b
c	63	99	c or \63	c
d	64	100	d or \64	d
e	65	101	e or \65	e
f	66	102	f or \66	f
g	67	103	g or \67	g
h	68	104	h or \68	h

**Table 10.9 ASCII Conversion Table (Continued)**

<b>ASCII</b>	<b>Hex</b>	<b>Decimal</b>	<b>Enter as</b>	<b>Displayed as</b>
i	69	105	l or \69	i
j	6A	106	j or \6A or \6a	j
k	6B	107	k or \6B or \6b	k
l	6C	108	l or \6C or \6c	l
m	6D	109	m or \6D or \6d	m
n	6E	110	n or \6E or \6e	n
o	6F	111	o or \6F or \6f	o
p	70	112	p or \70	p
q	71	113	q or \71	q
r	72	114	r or \72	r
s	73	115	s or \73	s
t	74	116	t or \74	t
u	75	117	u or \75	u
v	76	118	v or \76	v
w	77	119	w or \77	w
x	78	120	x or \78	x
y	79	121	y or \79	y
z	7A	122	z or \7A or \7a	z
{	7B	123	{ or \7B or \7b	{
	7C	124	or \7C or \7c	
}	7D	125	} or \7D or \7d	}
~	7E	126	~ or \7E or \7e	~
DEL	7F	127	\7F or \7f	?
	80 to FF	128 to 255	\80 to \FF	



## Understanding Interrupt Routines

This chapter contains general information about interrupt routines and explains how they function in your logic program. Each interrupt routine includes:

- an overview.
- programming procedure.
- operational description.
- associated bit description.

In addition, each interrupt routine contains an application example that shows the interrupt routine in use.

**Table 11.1 Interrupt Routine Instructions**

Instruction Mnemonic	Instruction Name	Purpose	Page
	User Fault Routine	Provides the option of preventing a processor shutdown.	11-2
<b>STI</b>	Selectable Timed Interrupt	Allows you to interrupt the scan of the main program file automatically, on a periodic basis, to scan a specified subroutine file.	11-8
<b>STD</b>	Selectable Timed Disable	Disables STI's from occurring.	11-16
<b>STE</b>	Selectable Timed Enable	Enables STI's to occur.	11-16
<b>STS</b>	Selectable Timed Start	Sets or changes the file number or setpoint frequency of the STI routine.	11-17
<b>DII</b>	Discrete Input Interrupt	Allows the processor to execute a subroutine when the input bit pattern of a discrete I/O card matches a compare value that you programmed.	11-18
<b>ISR</b>	I/O Interrupt	Allows a specialty I/O module to interrupt the normal processor operating cycle in order to scan a specified subroutine file.	11-27
<b>IID</b>	I/O Interrupt Disable	Disables I/O interrupts from occurring.	11-32
<b>IIE</b>	I/O Interrupt Enable	Enables I/O interrupts to occur.	11-32
<b>RPI</b>	Reset Pending Interrupt	Aborts a pending I/O Interrupt.	11-34
<b>INT</b>	Interrupt Subroutine	Optional instruction to identify interrupt subroutines.	11-34

## User Fault Routine Overview

Fixed	SLC 5/01	SLC 5/02	SLC 5/03	SLC 5/04	SLC 5/05
		•	•	•	•

The user fault routine gives you the option of preventing a processor shutdown when a specific user fault occurs. The file is executed when any recoverable or non-recoverable user fault occurs. The file is not executed for non-user faults.

A fault routine is programmed in a program file other than 2. The program file used is specified as the fault routine in word S:29 in the status file. More than one user fault routine can exist. The example on page 11-5 shows how this can be accomplished.

Faults are classified as recoverable and non-recoverable user faults, and non-user faults.

**Table 11.2 Fault Classification**

Non-User Fault	Non-Recoverable User Fault	Recoverable User Fault
The Fault Routine does not execute.	The Fault Routine executes for 1 pass.	The Fault Routine may clear the fault by clearing bit S:1/13.

**TIP**

You may initiate a MSG instruction to another node to identify the fault condition of the processor.

**TIP**

For SLC 5/02 processors: You must save your program with test single step selected in order for S:20 and S:21 to be activated.

For SLC 5/03 and higher processors: If your program contains four message instructions with the Continuous Operation (CO) bit set, the fault routine's message instruction is not executed.

## Status File Data Saved

Data in the following words is saved on entry to the user fault subroutine and re-written upon exiting the subroutine.

- S:0 Arithmetic flags
- S:13 and S:14 Math register
- S:24 Index register

## Creating a User Fault Subroutine

To use the user fault subroutine:

1. Create a subroutine file: valid range is 3-255.
2. Enter the file number in word S:29 of the status file.  
Project Tree - Controller Folder - Processor Status File - Errors Tab

The occurrence of recoverable or non-recoverable user faults causes the processor to read S:29 and execute the subroutine number contained in S:29. If the fault is recoverable, the routine can be used to correct the problem and clear the fault bit S:1/13. The processor then continues in the REM Run mode.

The routine does not execute for non-user faults.

Words S:20 and S:21 can be examined in your fault routine to pinpoint the file and rung number where the fault occurred. If the fault occurred outside of the ladder scan, this value will contain the rung number where the TND, END, or REF instruction is located. Use words S:20 and S:21 with your power-up protection fault routine to determine the exact point that the previous power down occurred.

## User Interrupt Routine Application Example

Suppose you have a program in which you want to control major errors 0020h (MINOR ERROR AT END OF SCAN) and 0034h (NEGATIVE VALUE IN TIMER PRE OR ACC) under the following conditions.

- Prevent a processor shutdown if the overflow trap bit S:5/0 is set.  
Permit a processor shutdown when S:5/0 is set more than five times.
- Prevent a processor shutdown if the accumulator value of timer T4:0 becomes negative. Reset the negative accumulator value to zero.  
Energize an output to indicate that the accumulator has gone negative one or more times.
- Allow a processor shutdown for all other user faults.

A possible method of accomplishing this is shown in the following examples. The user fault routine is designated as file 3.

When a recoverable or non-recoverable user error occurs, the processor scans subroutine file 3. The processor jumps to file 4 if the error code is 0020 and it jumps to file 5 if the error code is 0034h. For all other recoverable and non-recoverable errors, the processor exits the fault routine and halts operation in the fault mode.

*Fault Routine - Subroutine File 3*

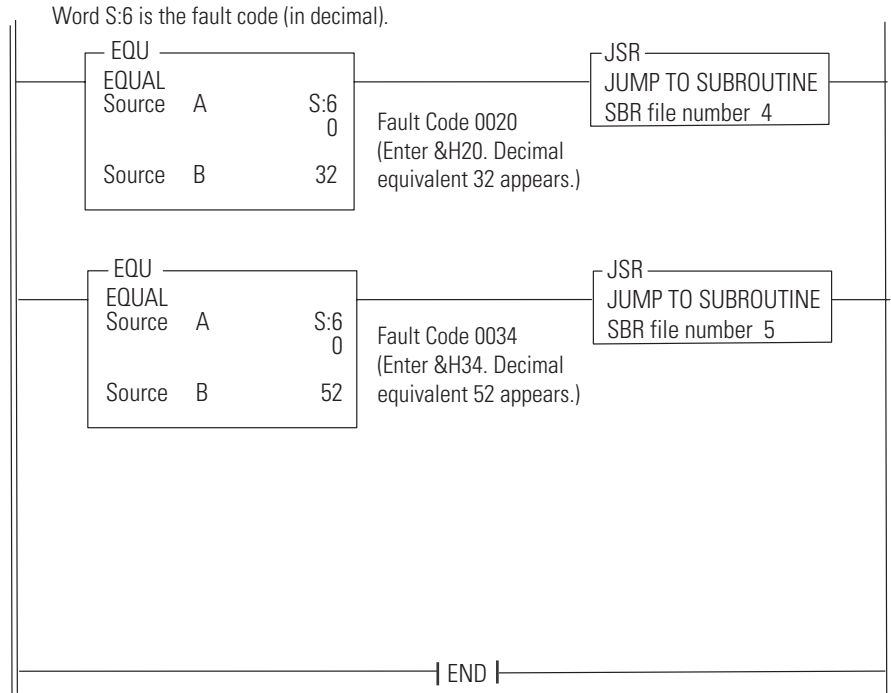

*Subroutine File 4 - Executed for Error 0020h*

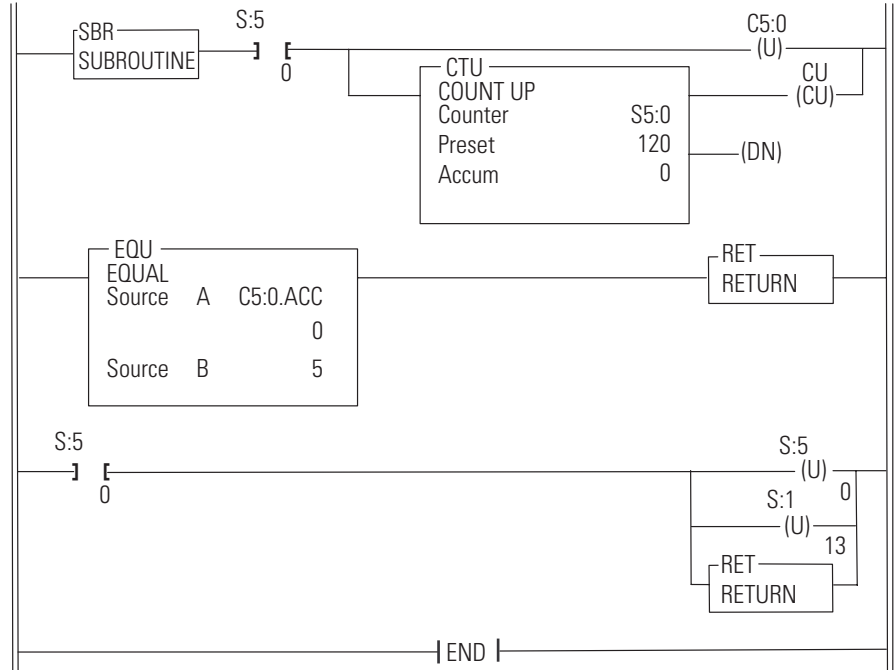

If the overflow trap bit, S:5/0 is set, counter C5:0 increments.

If the count of C5:0 is 4 or less, the overflow trap, S:5/0 is cleared, the major error halted bit S:1/13 is cleared, and the processor remains in the REM Run mode. If the count is equal to 5, the processor sets S:5/0 and S:1/13 and enters the Fault mode.

Subroutine file 5 is executed if the control register error bit S:5/2 is set.

*Subroutine File 5 - Executed for Error 0034h*

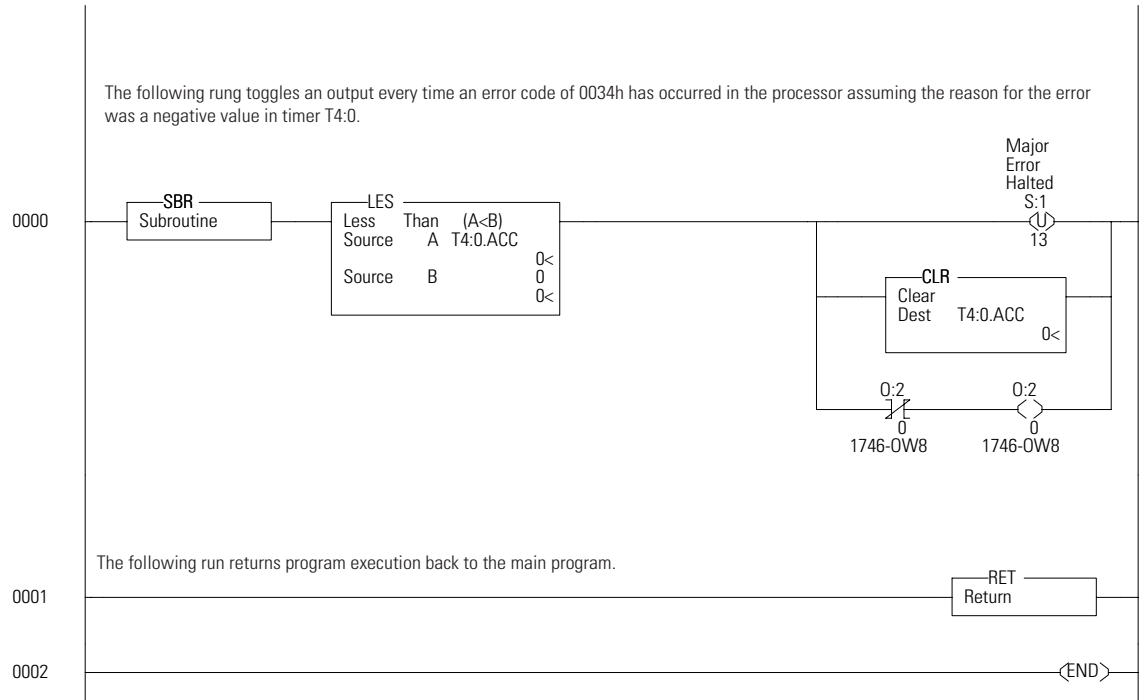

If the accumulator value of timer T4:0 is negative, the major error halted bit, S:1/13 is unlatched, preventing the processor from entering the Fault mode. At the same time, the accumulator value T4:0 ACC is cleared to zero and output O:2.0/0 is energized. Fault code 0034h is displayed in the status file.

If the preset of timer T4:0 is negative, S:1/13 remains set and the processor enters the Fault mode (O:2.0/0 will be reset if previously set). Also, if either the preset or accumulator value of any other timer in the program is negative, S:1/13 is set and the processor enters the Fault mode. If previously set, O:2.0/0 is reset.

## Selectable Timed Interrupt Overview

This function allows you to interrupt the scan of the processor automatically, on a periodic basis, to scan a specified subroutine file. Afterward, the processor resumes executing from the point where it was interrupted.

This section describes:

Fixed	SLC 5/01	SLC 5/02	SLC 5/03	SLC 5/04	SLC 5/05
		•	•	•	•

- STI programming procedure.
- STI operation and parameters.
- STD and STE instructions.
- STS instruction.

### Basic Programming Procedure for the STI Function

To use the STI function in your application file:

1. Create a subroutine file and enter the desired ladder rungs. This is your STI subroutine file. The valid range is 3 to 255.
2. Enter the STI subroutine file number in word S:31 of the status file (Project Tree - Controller Folder - Processor Status File - STI Tab). Refer to page B-45 in this manual for more information. A file number of zero disables the STI function.
3. Enter the setpoint (the time between successive interrupts) in word S:30 of the status file. Refer to page B-45 for more information.
  - For SLC 5/02: The range is 10 to 2550 ms (entered in 10 ms increments). A setpoint of zero disables the STI function. Refer to page B-16 in this manual for more information about the STI Resolution bit S:2/10.
  - For SLC 5/03: The range is 2 to 32,767 ms. A setpoint of zero disables the STI function. Refer to page B-16 in this manual for more information about the STI Resolution bit S:2/10.
  - For SLC 5/04 and higher processors: The range is from 1 to 32,767 ms (entered in 1 ms increments). A setpoint of zero disables the STI function.

#### TIP

The setpoint value must be a longer time than the execution time of the STI subrouting file plus the maximum interrupt latency, or a minor error bit is set. For all processors, the STI Pending bit and STI Overflow bit will be set. Additionally, for the SLC 5/03 and higher processors, the STI Lost bit may be set.



## Operation

After you download your program and enter the REM Run mode, the STI begins operation as follows.

1. The STI timer begins timing.
2. When the STI interval expires, the STI timer is reset, the processor scan is interrupted and the STI subroutine file is scanned.
3. If while executing the STI subroutine, another STI interrupt occurs, the STI Pending bit (S:2/0) is set.
4. If while an STI is pending, the STI timer expires, the STI Lost bit (S:36/9) is set. (For SLC 5/02 processors, the Overflow (S:5/10) bit is set.)
5. When the STI subroutine scan is completed, scanning of the main program file resumes at the point where it left off, unless an STI is pending. In this case, the subroutine is immediately scanned again.
6. The cycle repeats.

For identification of your STI subroutine, include an INT instruction as the first instruction on the first rung of the file.

## STI Subroutine Content

The STI subroutine contains the rungs of your application logic. You can program any instruction inside the STI subroutine except a TND, REF, or SVC instruction. IIM or IOM instructions are needed in an STI subroutine if your application requires immediate update of input or output points. End the STI subroutine with an RET instruction.

JSR stack depth is limited to 3. You may call other subroutines to a level 3 deep from an STI subroutine.

## Interrupt Latency and Interrupt Occurrences

Interrupt latency is the interval between the STI time-out and the start of the interrupt subroutine. STI interrupts can occur at any point in your program, but not necessarily at the same point on successive interrupts. The tables below show the interaction between an interrupt and the processor operating cycle.

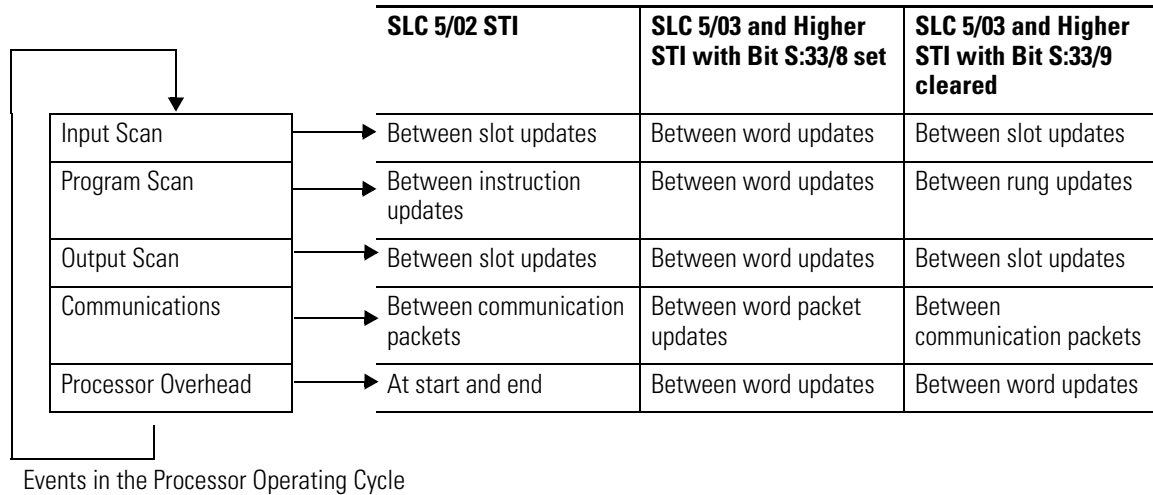

Note that STI execution time adds directly to the overall scan time. During the latency period, the processor is performing operations that cannot be disturbed by the STI interrupt function.

Latency periods are:

- SLC 5/02 processors interrupts are serviced within 2.4 ms maximum.
- SLC 5/03 and higher processors: If an interrupt occurs while the processor is performing a multi-word slot update and your interrupt subroutine accesses that same slot, the multi-word transfer finishes to completion prior to performing the interrupt subroutine slot access. The Interrupt Latency Control bit (S:33/8) functions:
  - when the bit is set (1), interrupts are serviced within the interrupt latency time.
  - when the bit is clear (0), INTs are serviced per rung, slot, and packet execution time.

The default state is cleared (0). To determine the interrupt latency with S:33/8 clear, you must calculate the execution time of each and every rung in your program. Use the longest calculated execution time plus your maximum interrupt latency.

## Interrupt Priorities

**Table 11.3 Interrupt Priorities**

<b>SLC 5/02 Processor</b>	<b>SLC 5/03 and Higher Processors</b>
1. User Fault Routine	1. User Fault Routine
2. Selectable Timed Interrupt Subroutine	2. Discrete Input Interrupt (DII)
3. Interrupt Subroutine (ISR)	3. Selectable Timed Interrupt Subroutine
	4. Interrupt Subroutine (ISR)

An executing interrupt can only be interrupted by an interrupt having higher priority.

**TIP**

Under certain conditions, though, it is possible for a lower priority task to run during the DII execution.

## Status File Data Saved

Data in the following words is saved on entry to the STI subroutine and re-written upon exiting the STI subroutine.

- S:0 Arithmetic flags
- S:13 and S:14 Math register
- S:24 Index register

## STI Parameters

The following parameters are associated with the STI function. These parameters have status file addresses that are described here.

- STI file number (Word S:31) - This can be any number from 3 to 255. A value of zero disables the STI function. An invalid number generates fault 0023h.
- Setpoint (Word S:30) - This is the time between the starting point of successive scans of the STI file. It can be any value from 10 to 2550 milliseconds. (For SLC 5/02 see page 11-8.) You enter a value of 1 to 255, which results in a 10 to 2550 ms setpoint. A value of zero disables the STI function. An invalid time generates fault 0024h.

*SLC 5/03 and higher processors:* If S:2/10 is set, time is in 1 ms increments. If this bit is clear, time is in 10 ms increments.

If the STI is initiated while in the REM Run mode by loading the status registers, the interrupt starts timing from the end of the program scan in which the status registers were loaded. If the STI has been previously configured (with a different setpoint), the new setpoint takes effect only after the previously-configured STI has timed out.

- STI Pending Bit (S:2/0) - This bit is set when the STI timer has timed out and the STI routine is waiting to be executed. This bit is reset upon starting the STI routine, execution of a true STS instruction, power-up, or exit from the REM Run or Test mode.

*SLC 5/02 specific:* The STI pending bit is not set if the STI timer expires while executing the fault routine.

*SLC 5/03 and higher processors:* This bit is set if the STI timer expires while executing the DII subroutine or fault routine.

- STI Enable Bit (S:2/1) - The default value is 1 (set). When a file number between 3 and 255 is present in word S:31 and a setpoint value between 1 and 255 is present in word S:30, a set enable bit allows scanning of the STI file. If the bit is reset by an STD instruction, scanning of the STI file no longer occurs. If the bit is set by an STE or STS instruction, scanning is again allowed. The enable bit only enables/disables the scanning of the STI subroutine. It does not affect the STI timer. The STS instruction affects both the enable bit and the STI timer. The default state is enabled. If this bit is set or reset using the STE, STD, or STS instruction, enable/disable takes effect immediately. If this bit is set in the user program using an instruction other than STE, STD, or STS, it takes effect at the next end of scan.

*SLC 5/02 specific:* If this bit is set or reset by the user program or communications, it does not take effect until the next end of scan.

*SLC 5/03 and higher processors:* If this bit is set or reset by the user program or communications, it takes effect upon the STI timer expiration or next end of scan (whichever occurs first).

- STI Executing Bit (S:2/2) - This bit is set when the STI file is being scanned and cleared when the scan is completed. The bit is also cleared on power-up and entry into the REM Run mode.
- STI Resolution Selection Bit (S:2/10) - This bit is clear by default. When clear, this bit selects a 10 ms increment for the STI Setpoint (S:30) value. When set, this bit selects a 1 ms increment for the STI Setpoint (S:30) value. To program this feature, use the data monitor function to set/clear this bit, or address this bit with your ladder program.

This bit is user configurable and takes effect on a REM PROG to REM RUN mode transition.

- Overflow Bit (S:5/10) - This minor error bit is set whenever the STI timer expires while the STI routine is executing or disabled while the pending bit is set. When this occurs, the STI timer continues to operate at the rate present in word S:30. If the overrun bit becomes set, take the corrective action your application dictates, then clear the bit.
- STI Lost Bit (Word S:36/9) - This bit is set anytime an STI interrupt occurs while the STI Pending bit is also set. When set, you are notified that a STI interrupt has been lost. For example, the interrupt is lost because a previous interrupt was already pending and waiting execution. Examine this bit in your user program and take appropriate action if your application cannot tolerate this condition. Then clear this bit with your user program in order to prepare for the next possible occurrence of this error.

Use the following rungs to initialize and measure the amount of time between two consecutive STI subroutine executions. The 10  $\mu$ s timer is also available in the DII interrupt and I/O interrupt. This application example can also be used for the Event I/O interrupt or the DII interrupt by replacing S:43 with either S:44 or S:45 respectively.

STI Example

The following program will demonstrate a STI.  
 The following values need to be loaded into S:30 (1), S:31 (4) and S:2/10 (0) in STI setup.  
 This will guarantee that subroutine (4) will be executed every 10 ms.  
 The subroutine program will calculate the time difference from its last execution.  
 The following rung will ensure that the interrupt measurement is initialized each time the run mode is entered

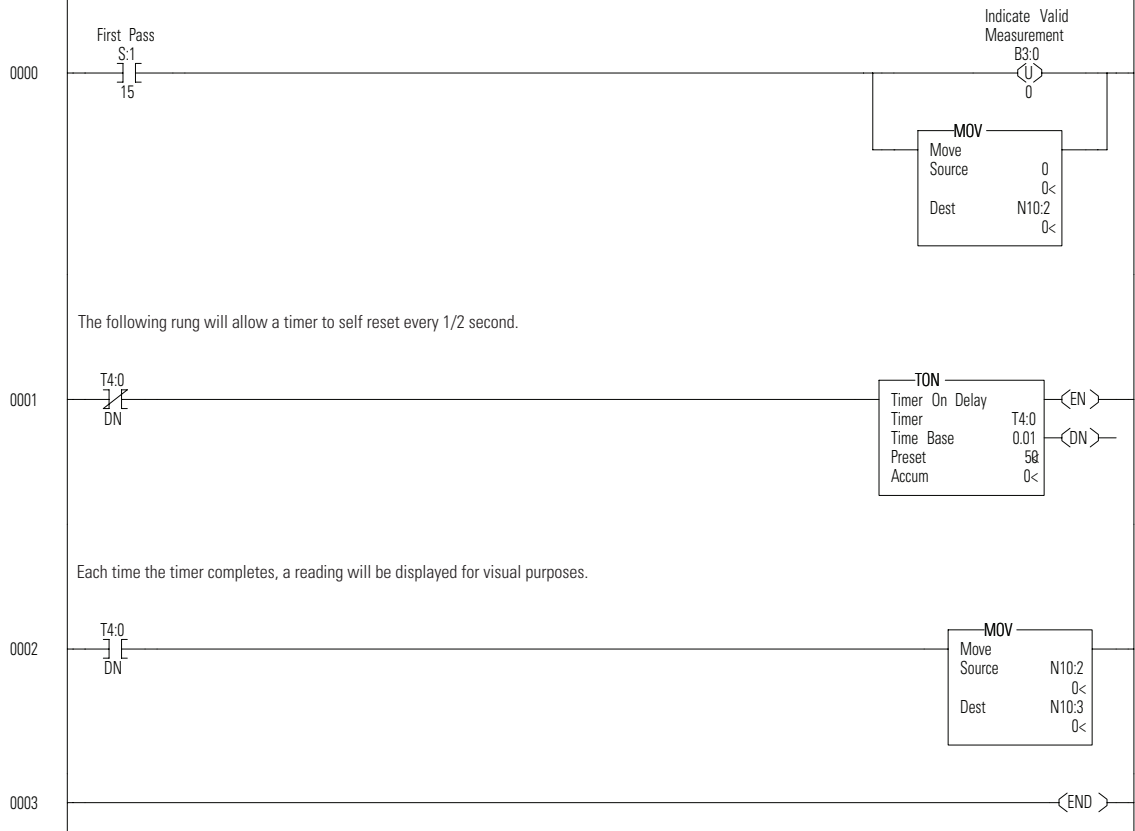

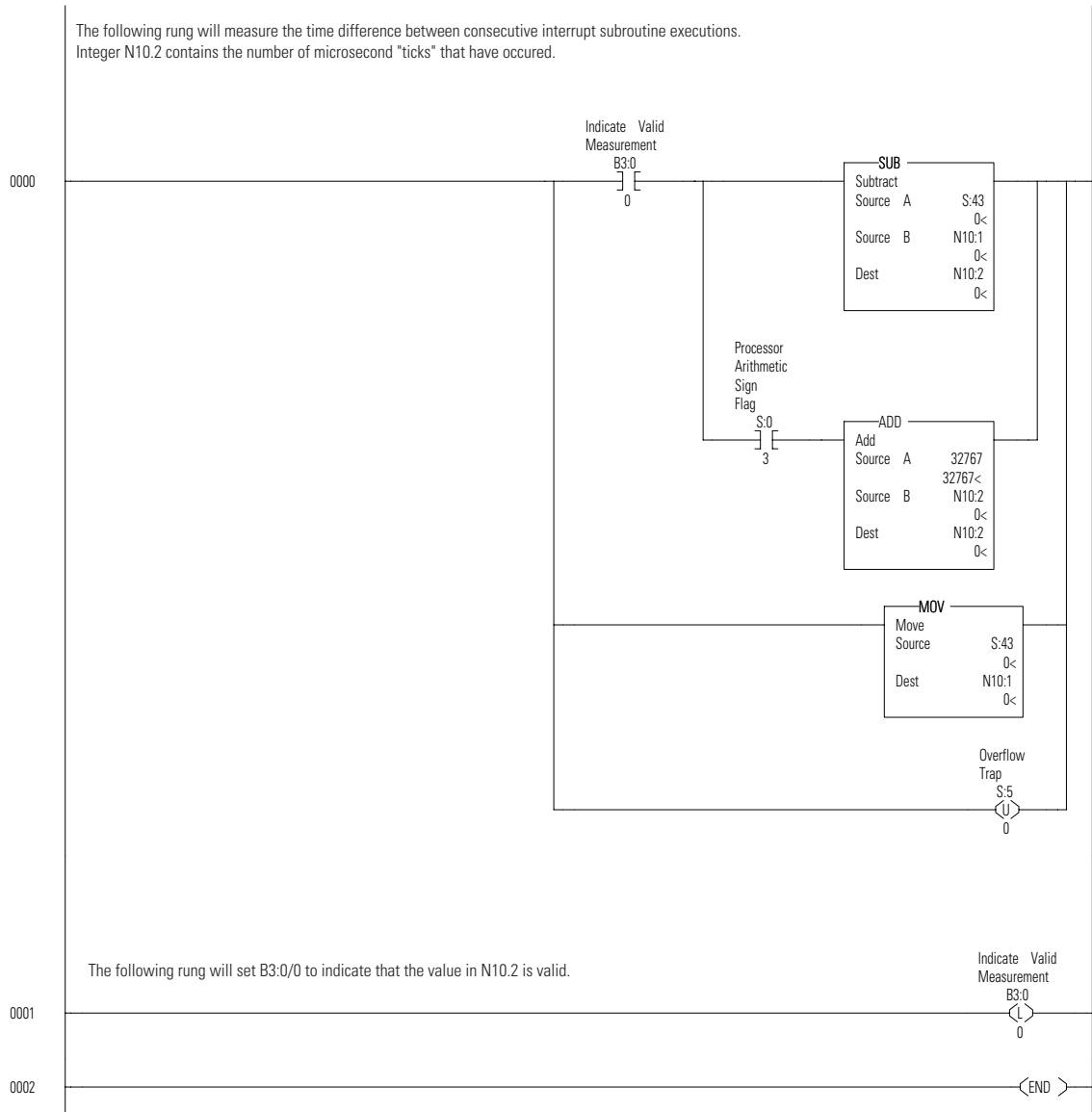

**TIP**

The math overflow selection bit (S:2/14) must be set prior to entering RUN mode.

## STD and STE Instructions

The STD and STE instructions are used to create zones in which STI ladder execution *cannot* occur. The STI timer continues to operate at the rate present in word S:30.

### Selectable Timed Disable - STD

Fixed	SLC 5/01	SLC 5/02	SLC 5/03	SLC 5/04	SLC 5/05
		•	•	•	•

When true, this instruction resets the STI enable bit and prevents the STI subroutine from executing. When the rung goes false, the STI enable bit remains reset until a true STS or STE instruction is executed. The STI timer continues to operate while the enable bit is reset.

### Selectable Timed Enable - STE

This instruction, upon a false-true transition of the rung, sets the STI enable bit and allows execution of the STI subroutine. When the rung goes false, the STI enable bit remains set until a true STD instruction is executed. This instruction has no effect on the operation of the STI timer or setpoint. When the enable bit is set, the first execution of the STI subroutine can occur at any fraction of the timing cycle up to a full timing cycle later.

### STD/STE Zone Example

In the program that follows, the STI function is in effect. The STD and STE instructions in rungs 6 and 12 are included in the ladder program to avoid having STI subroutine execution at any point in rungs 7 through 11.

The STD instruction (rung 6) resets the STI enable bit and the STE instruction (rung 12) sets the enable bit again. The STI timer increments and may time out in the STD zone, setting the pending bit S:2/0 and overrun bit S:5/10.

The first pass bit S:1/15 and the STE instruction in rung 0 are included to insure that the STI function is initialized following a power cycle. You should include this rung any time your program contains an STD/STE zone or an STD instruction.



**Program File 3**

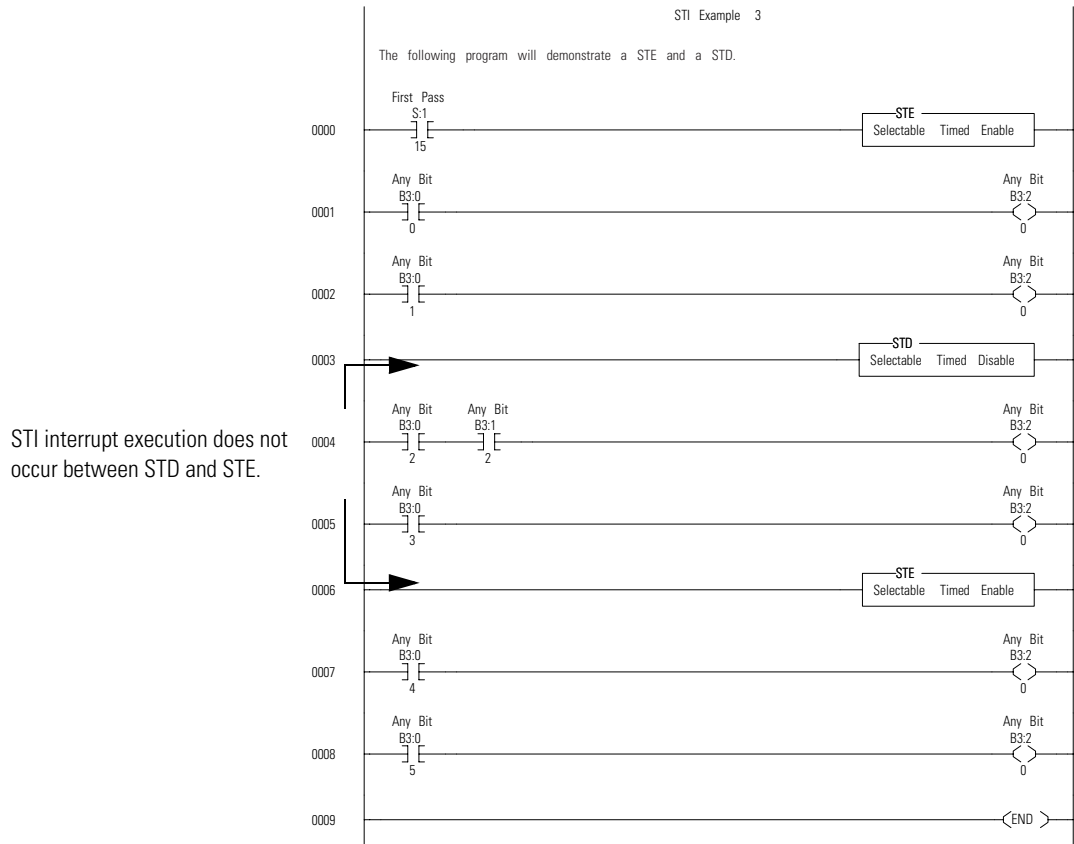

**Selectable Timed Start (STS)**

Use the STS instruction to condition the start of the STI timer upon entering the REM Run mode - rather than starting automatically. You can also use it to set up or change the file number or setpoint/frequency of the STI routine that is executed when the STI timer expires.

This instruction is not required to configure a basic STI interrupt application.

The STS instruction requires you to enter two parameters, the STI file number and the STI setpoint. Upon a true execution of the rung, this instruction enters the file number and setpoint in the status file (S:31, S:30), overwriting the existing data. At the same time, the STI timer is reset and begins timing; at timeout, the STI subroutine execution occurs. When the rung goes false, the STI function remains enabled at the setpoint and file number you've entered in the STS instruction.



Fixed	SLC 5/01	SLC 5/02	SLC 5/03	SLC 5/04	SLC 5/05
		•	•	•	•

**TIP**

SLC 5/03 and higher processors: The STS instruction uses the setting of the STI resolution bit S:2/10 to determine the timebase to be used upon STS instruction execution.

## Discrete Input Interrupt Overview

Fixed	SLC 5/01	SLC 5/02	SLC 5/03	SLC 5/04	SLC 5/05
			•	•	•

Use the Discrete Input Interrupt (DII) for high-speed processing applications or any application that needs to respond to an event quickly. This instruction allows the processor to execute a ladder subroutine when the input bit pattern of a discrete I/O card matches a compare value that you programmed.

The status file contains six bit values and six word values used to program and monitor the DII function. The DII does not require ladder logic instructions for configuration. You program the DII to examine the input bit pattern of the first bits of any single I/O slot, which contains any discrete input card (such as IG16, IV16, IB8, IB32). When the input bit pattern matches the compare value, the accumulator is incremented. The DII accumulator counts to the preset value and, once the interrupt is generated, it immediately wraps around and begins counting again at zero.

While scanning the DII subroutine, you can reconfigure the DII to look for an entirely different event. This facilitates DII sequencing. The DII can be programmed to compare each input point to either a high (1) or low (0) state. The accumulator is incremented on the input transition that causes the input points to match the compare value.

IIM or IOM instructions are needed in the DII subroutine if your application requires immediate update of input or output points. End the DII subroutine with an RET instruction.

### Basic Programming Procedure for the DII Function

To use the DII function with your main program file:

1. Create a subroutine file (range is from 3 to 255) and enter the desired ladder rungs. This is your DII subroutine file.  
(Project Tree - Controller Folder - Processor Status File - DII Tab)
2. Enter the Input Slot number (word S:47).
3. Enter the Bit Mask (word S:48). Valid Bit Masks range from 0 to 255.
4. Enter the Compare Value (word S:49). Valid Compare Values range from 0 to 255.
5. Enter the Preset Value (word S:50). Valid Preset Values range from 0 to 32,767.
6. Enter the DII subroutine File Number in word S:46 of the status file.  
(See page B-55.) A zero value disables the DII function.

**TIP**

PLC users: The main difference between the DII and the PLC 5/40 PII is that the DII requires all stated transitions to occur prior to generating a count, while the PII requires that only one of the stated transitions occur. Also, the PLC term “count” is referred to as “preset” in the DII.

*Example*

The DII can be programmed to count items on a high-speed conveyor. Each time 100 items pass a photo-switch, the DII subroutine is executed. The DII subroutine then uses Immediate I/O instructions to package the products.

## Operation

After you download your program and enter the REM Run mode, the DII begins operation as follows.

### Counter Mode

This mode is active when the Preset Value (S:50) contains a value greater than 1.

1. The DII reads the first byte of input data of a selected discrete input card at least once every 100 $\mu$ s.<sup>(1)</sup> Note that this “polling” of the input data has no effect on processor scan time.
2. When the input data matches the programmed masked value, the accumulator is incremented by one. The next count occurs when input data transitions to non-matched and then back to matched.
3. When the accumulator reaches or exceeds the preset value, between 1 and 32,767, the interrupt is generated and the accumulator is reset to zero.
4. The DII subroutine is executed.
5. The cycle repeats.

<sup>(1)</sup> You must add interrupt latency time to the final transition or count that causes the interrupt subroutine to execute.

## Event Mode

This mode is active when the preset value (S:50) contains a 0 or 1.

1. The DII reads the first byte of input data of a selected discrete input card at least once every 100 $\mu$ s.<sup>(1)</sup> Note that this “polling” of the input data has no effect on processor scan time.
2. When the input data matches the programmed masked value, the interrupt is generated.
3. The DII subroutine is executed.<sup>(2)</sup>
4. The cycle repeats.<sup>(1)</sup>

## DII Subroutine Content

For identification of your DII subroutine, use the INT instruction as the first instruction in your first rung.

The DII subroutine contains the rungs of your application logic. You can program any instruction inside the DII subroutine except a TND, REF, or SVC instruction. IIM or IOM instructions are needed in a DII subroutine if your application requires immediate update of input or output points. End the DII subroutine with an RET instruction.

JSR stack depth is limited to 3. You may call other subroutines to a level 3 deep from an DII subroutine.

<sup>(1)</sup> You must add interrupt latency time to the final transition or count that causes the interrupt subroutine to execute.

<sup>(2)</sup> The DII continues to compare the input data to the programmed masked value while executing the DII subroutine.

## Interrupt Latency and Interrupt Occurrences

Interrupt latency is the interval between DII detection and the start of the interrupt subroutine. DII interrupts can occur at any point in your program, but not necessarily at the same point on successive interrupts. Interrupts can occur between instructions in your program, inside the I/O scan (between slots), or between the servicing of communications packets. The table below shows the interaction between an interrupt and the processor operating cycle.

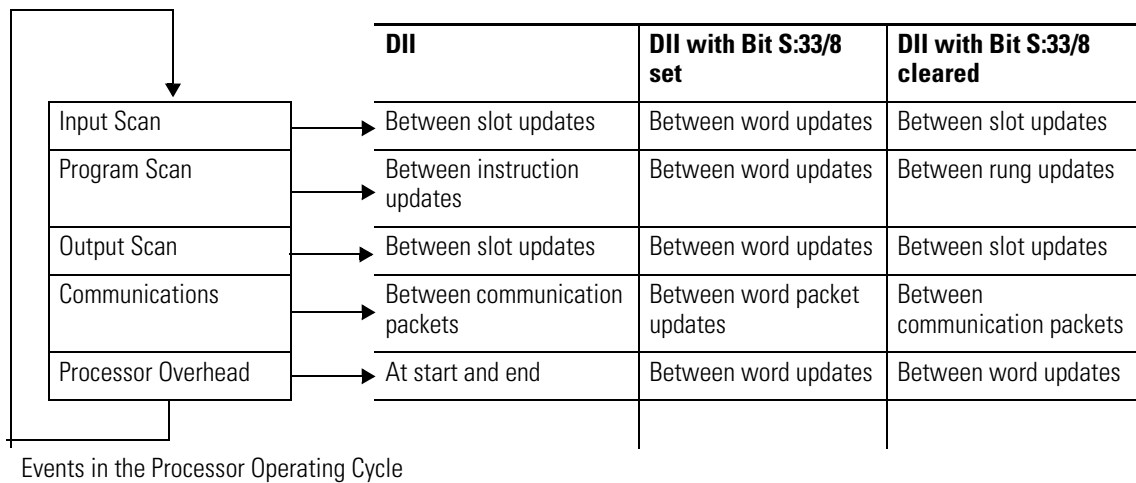

If an interrupt occurs while the SLC 5/03 (or higher) processor is performing a multi-word slot update and your interrupt subroutine accesses that same slot, the multi-word transfer completes prior to performing the interrupt subroutine slot access.

Note that DII execution time adds directly to the overall scan time. During the latency period, the processor is performing operations that cannot be disturbed by the DII interrupt function. The Interrupt Latency Control Bit (S:33/8) functions as follows.

- When the bit is set (1) interrupts are serviced within the minimum time possible. The time will vary depending upon which processor and communication protocol you are using.
- The default state is cleared (0). When S:33/8 is clear (0), user interrupts occur between rungs and I/O slot updates. To determine the interrupt latency with S:33/8 clear, you must calculate the execution time of each and every rung of your program, then add the execution time of the longest rung to the latency time.

## Interrupt Priorities

Interrupt priorities for the SLC 5/03 and higher processors are:

1. User fault routine.
2. Discrete Input Interrupt (DII).
3. STI Subroutine.
4. I/O Interrupt Subroutine.

An executing interrupt subroutine can only be interrupted by the fault routine.

**TIP**

Under certain conditions, though, it is possible for a lower priority task to run during the DII execution.

## Status File Data Saved

Data in the following words is saved on entry to the DII subroutine and re-written upon exiting the DII subroutine.

- S:0 Arithmetic flags
- S:13 and S:14 Math register
- S:24 Index register

## Reconfigurability

You can reconfigure the DII entirely or in part, depending on the particular parameter(s) you choose. You can reconfigure some of the parameters simply by writing the new value over the old value. Other values require you to set the reconfiguration bit in addition to writing the new value. The DII is non-retentive and always reconfigures itself upon entry into the REM Run mode. Refer to "DII Parameters" for details on reconfiguring each parameter.

### *Example*

The DII can be programmed to count items on a high-speed conveyor. Each time 100 items pass a photo-switch, the DII subroutine is executed. The DII subroutine then uses Immediate I/O instructions to package the products.

If you want to vary the number of items that are packaged together, simply change the number in the DII preset parameter using a MOV instruction.

## DII Parameters

The following parameters are associated with the DII function. These parameters have status file addresses that are described here.

- DII Pending Bit (S:2/11) - When set, this bit indicates that the DII Accumulator (S:52) equals the DII preset (S:50) and the ladder file number specified by the DII File Number (S:46) is waiting to be executed. It is cleared when the DII File Number (S:46) begins executing, or on exit from the REM Run or REM Test mode.
- DII Enable Bit (S:2/12) - To program this feature, use the data monitor function to set/clear this bit, or address this bit with your ladder program. This bit is set in its default condition. If set, it allows execution of the DII subroutine if the DII File Number (S:46) is non-zero. If clear, when the interrupt occurs, the DII subroutine will not execute and the DII Pending bit is set. The DII function continues to run anytime the DII file (S:46) is non-zero. If the pending bit is set, the enable bit is examined at the next end of scan.
- DII Executing Bit (S:2/13) - When set, this bit indicates that the DII interrupt has occurred and the DII subroutine is currently being executed. This bit is cleared on completion of the DII routine, power-up, or REM Run mode entry.
- DII Overflow Bit (S:5/12) - This bit is set whenever the DII interrupt occurs while still executing the DII subroutine or whenever the DII interrupt occurs while pending or disabled.
- Reconfigure Bit (S:33/10) - When this bit is set (1), it indicates that at the next end of scan (END, TND, or REF), fault routine exit, STI ISR exit, Event ISR exit, or next DII ISR exit the:
  - DII accumulator is cleared,
  - values at status words S:47 to S:50 are applied,
  - the pending bit is cleared, and
  - the DII Reconfigure bit is cleared.
- DII Lost Bit (S:36/8) - This bit is set if a DII interrupt occurs while the DII Pending bit is set.
- File Number (Word S:46) - Enter a program file number (3 to 255) to be used as the discrete input interrupt subroutine. Write a 0 value to disable the function. This value is applied upon detection of a DII Reconfigure bit, each DII ISR exit, and each end of scan (END, TND, or REF).
- Slot Number (Word S:47) - You enter the slot number (1 to 30) to be used as the discrete input interrupt subroutine. A zero value disables the function. This value is applied on detection of the DII Reconfigure bit, or on entry into the REM Run mode.

- **Bit Mask (Word S:48)** - You enter the bit-mapped value that corresponds to the bits you wish to monitor on the discrete I/O module (0 to 255). Only bits 0 to 7 are used in the DII function. Setting a bit indicates that you wish to include the bit in the comparison of the discrete I/O card's bit pattern to the DII compare value (S:49). This value is applied on detection of the DII Reconfigure bit, each DII ISR exit, and at each end of scan (END, TND, or REF).
- **Compare Value (Word S:49)** - You enter a bit-mapped value that corresponds to the bit pattern that must occur on the discrete I/O card for a count or interrupt to occur (0 to 255). Only bit 0 to 7 are used in the DII function. The bit must be set (1) or cleared (0) in order to satisfy the compare condition for that bit. An interrupt or count is generated upon the last bit transition of the compare value. This value is applied on detection of DII Reconfigure bit, each DII ISR exit, and at each end of scan (END, TND, or REF).

To provide protection from inadvertent data monitor alteration of your selection, program an unconditional MOV instruction containing the compare value of the DII to S:49.

- **Preset (Word S:50)** - When this value is equal to 0 or 1, an interrupt is generated each time the comparison specified in words S:48 and S:49 is satisfied. When this value is between 2 and 32767, a count occurs each time the bit comparison is satisfied. An interrupt is generated when the accumulator value reaches 1 or exceeds the preset value. This value is applied on detection of DII Reconfigure bit, each DII ISR exit, and at each end of scan (END, TND, or REF).

To provide protection from inadvertent data monitor alteration of your selection, program an unconditional MOV instruction containing the preset value of the DII to S:50.

- **Return Mask (Word S:51)** - The Return Mask is updated immediately preceding entry into the DII subroutine. This value contains the bit map of the last bit transition that caused the interrupt. If more than one bit transitions in the same 100 $\mu$ s DII sample period, it is included in the return mask. This bit is cleared by the processor on exit from the DII subroutine. Use this value to validate the last interrupt transition that caused the input pattern to match the compare value. Or when dynamically reconfiguring (sequencing) the DII, use this value inside of your DII's subroutine to help determine/validate its position of the sequence.
- **Accumulator (Word S:52)** - The DII accumulator contains the number of counts that have occurred. When a count occurs and the accumulator is greater than or equal to the preset value, a DII interrupt is generated and the accumulator is cleared.



For applications that measure the rate of incoming DII pulses while using a STI (Selectable Timed Interrupt), SLC 5/03 OS301 and above updates the DII accumulator prior to executing the first rung of the STI subroutine.

## Discrete Input Interrupt Application Example

The following example shows how to use the Discrete Input Interrupt to control a high-speed application. In the example, the DII is used to ensure that all bottles exiting a filling and capping machine have their caps installed.

The bottle proximity switch is used as the DII input. When a bottle passes the proximity switch, the processor executes the DII subroutine. In the subroutine the processor reads the state of the cap proximity switch. If the cap is installed, the chute solenoid does not energize; allowing the bottle to continue down the line. If the cap is missing, the chute solenoid energizes, causing the defective bottle to divert down the chute and into the reject bin.

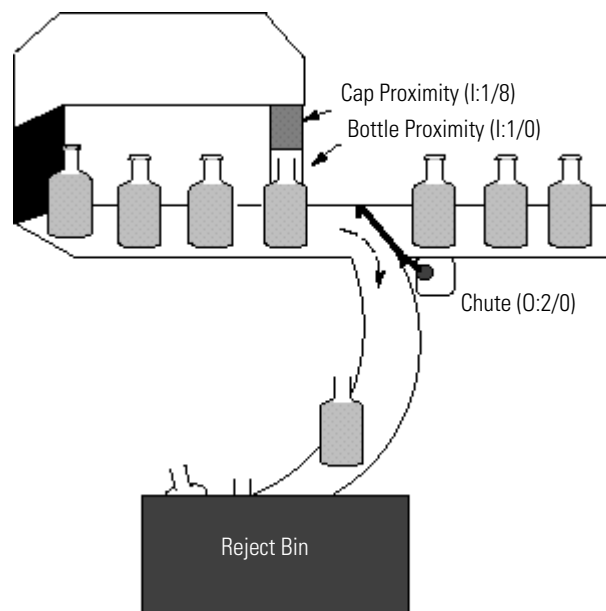

The following parameters are used to program the DII for the above application.

- S:33/8 Interrupt Latency Control Bit = 1
- S:46 File = 3
- S:47 Slot = 1
- S:48 Mask = 00000001
- S:49 Compare = 00000001
- S:50 Preset = 1

### Ladder Diagram for the Bottling Application

DII Example 4

The following program will demonstrate a DII.

The following values need to be loaded into S:33/8 (1), S:46 (3), S:47 (1), S:49 (1) and S:50 (1) in the DII setup.

This will guarantee that subroutine (3) will be executed every time that I:1.0/0 is true.

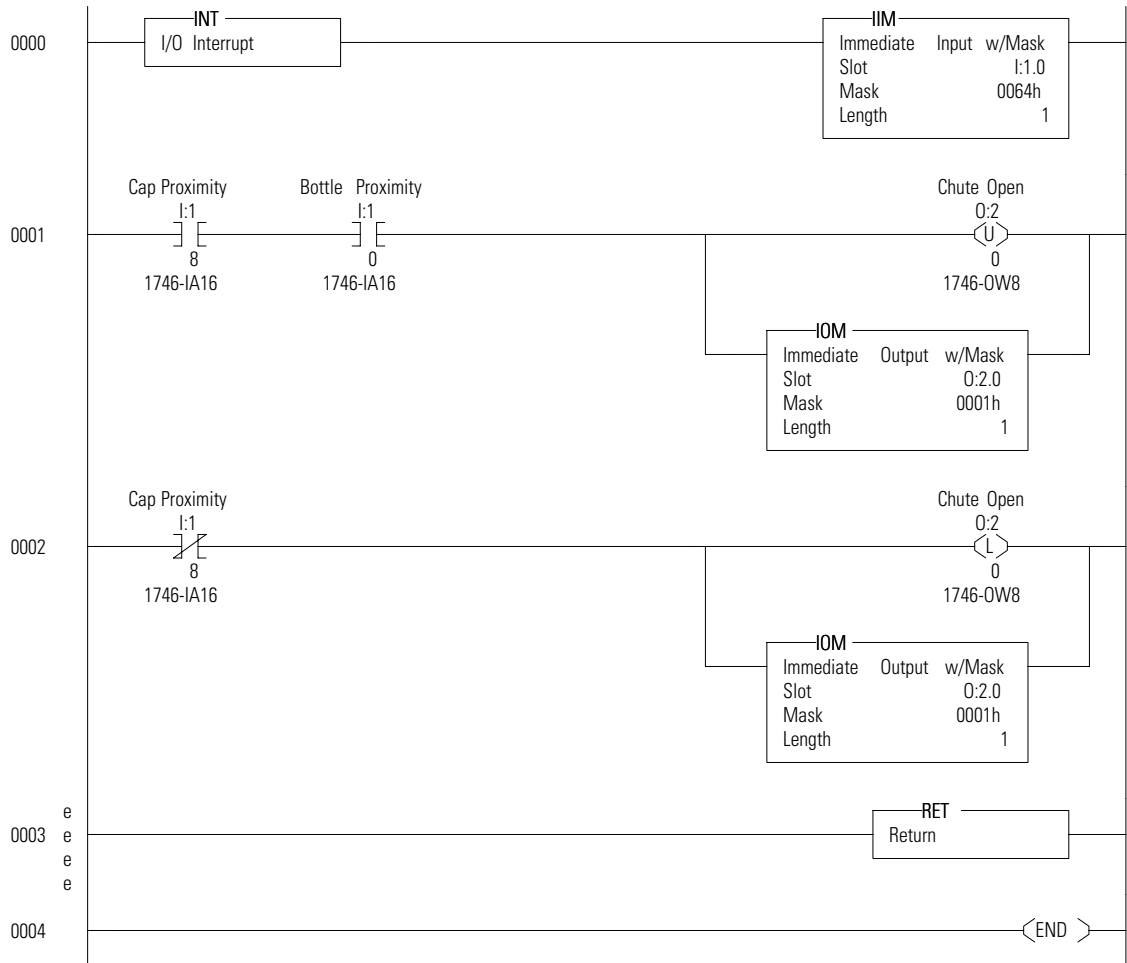

## I/O Interrupt Overview (ISR)

This function allows a specialty I/O module to interrupt the normal processor operating cycle in order to scan a specified subroutine file. Interrupt operation for a specific module is described in the user's manual for the module.

Not all specialty I/O modules are capable of generating I/O interrupts. Refer to the user manual of the specific specialty I/O module to see if it supports this feature. For example, you cannot use a standard discrete I/O module to accomplish an I/O event-driven interrupt.

Fixed	SLC 5/01	SLC 5/02	SLC 5/03	SLC 5/04	SLC 5/05
		•	•	•	•

This section describes:

- I/O operation.
- I/O interrupt parameters.
- IID and IIE instructions.
- RPI instruction.
- INT instruction.

## Basic Programming Procedure for the I/O Interrupt Function

- When you are configuring the specialty I/O module slot with the programming device, make sure you program the "ISR" (interrupt subroutine) program file number (range 3 to 255) that you want the processor to execute when the module generates an interrupt. Specialty I/O modules that create interrupts should be configured in the lowest numbered I/O slots.
- Create the subroutine file that you have specified as the ISR number in the I/O module slot configuration.

## Operation

When you restore your program and enter the REM Run mode, the I/O interrupt begins operation as follows.

1. The specialty I/O module determines that it needs servicing and generates an interrupt request to the SLC processor.
2. The processor is interrupted from what it is doing, and the specified interrupt subroutine file (ISR) is scanned.
3. When the ISR scan is completed, the specialty I/O module is notified. This informs the specialty I/O module that it is allowed to generate a new interrupt.
4. The processor resumes normal operation from where it left off.

## Interrupt Subroutine (ISR) Content

The Interrupt Subroutine (INT) instruction should be the first instruction in your ISR. This identifies the subroutine file as an I/O interrupt subroutine.

The ISR contains the rungs of your application logic. You can program any instruction inside an ISR except a TND, REF, or SVC instruction. IIM or IOM instructions are needed in an ISR if your application requires immediate update of input or output points. Terminate the ISR with an RET (return) instruction.

JSR stack depth is limited to 3. That is, you may call other subroutines to a level 3 deep from an ISR.

## Interrupt Latency and Interrupt Occurrences

Interrupt latency is the interval between the I/O module's request for service and the start of the interrupt subroutine. I/O interrupts can occur at any point in your program, but not necessarily at the same point on successive interrupts. Interrupts can only occur between instructions in your program, inside the I/O scan (between slots), or between the servicing of communication packets. The following table shows the interaction between an interrupt and the processor operating cycle.

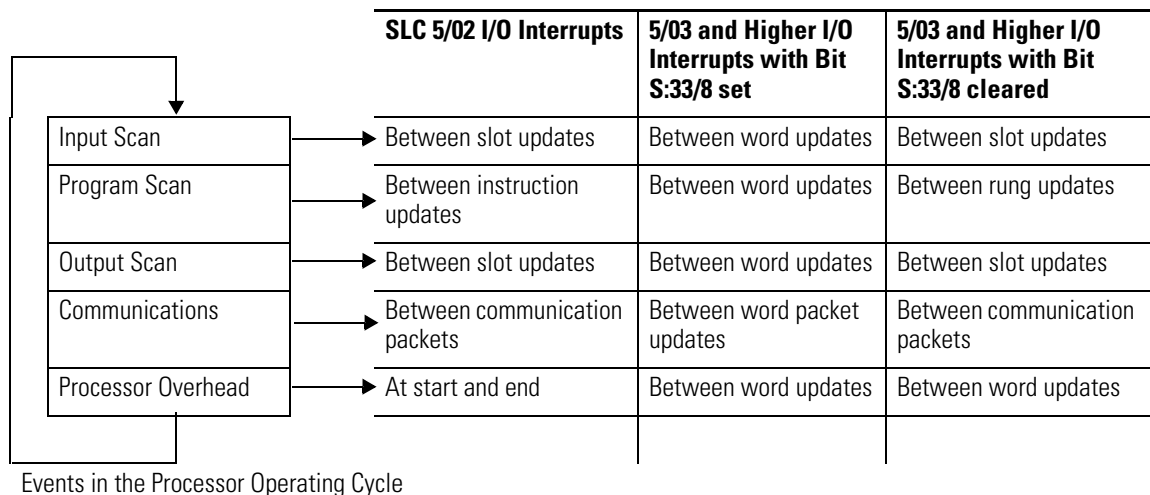

Note that ISR execution time adds directly to the overall scan time. During the latency period, the processor is performing operations that cannot be disturbed by the ISR interrupt function.

Latency periods are:

- SLC 5/02 interrupts are serviced within 2.4ms maximum.
- SLC 5/03 and higher processors: If an interrupt occurs while the processor is performing a multi-word slot update and your interrupt subroutine accesses that same slot, the multi-word transfer finishes to completion prior to performing the interrupt subroutine slot access. The Interrupt Latency Control bit (S:33/8) functions:
  - when the bit is set (1) interrupts are serviced within the interrupt latency time.
  - when S:33/8 is clear (0), user interrupts occur between rungs and I/O slot updates.

The default state is cleared (0). To determine the interrupt latency with S:33/8 clear, you must calculate the execution time of each and every rung in your program.

## Interrupt Priorities

Interrupt priorities are as follows.

**Table 11.4 Interrupt Priorities**

<b>SLC 5/02 Processor</b>	<b>SLC 5/03 and Higher Processors</b>
1. Fault Routine	1. Fault Routine
2. STI Subroutine	2. Discrete Input Interrupt (DII)
3. I/O Interrupt Subroutine (ISR)	3. STI Subroutine
	4. I/O Interrupt Subroutine (ISR)

An executing interrupt can only be interrupted by an interrupt having higher priority. The I/O interrupt cannot interrupt an executing fault routine, an executing DII subroutine, an executing STI subroutine, or another executing I/O interrupt subroutine. If an I/O interrupt occurs while the fault routine, DII, or STI subroutine is executing, the processor waits until the higher priority interrupts are scanned to completion. The I/O interrupt subroutine is then scanned.

**TIP**

SLC 5/02 specific: It is important to understand that the I/O pending bit associated with the interrupting slot remains clear during the time that the processor is waiting for the fault routine or STI subroutine to finish.

SLC 5/03 and higher processors: The I/O pending bit is always set when the interrupt occurs. You can examine the state of these bits within your higher priority interrupt routines.

If a major fault occurs while executing the I/O interrupt subroutine, execution immediately switches to the fault routine. If the fault was recovered by the fault routine, execution resumes at the point that it left off in the I/O interrupt subroutine. Otherwise, the fault mode is entered.

If a DII interrupt occurs while executing the I/O interrupt subroutine, execution immediately switches to the DII subroutine. When the DII subroutine is scanned to completion, execution resumes at the point that it left off in the I/O interrupt subroutine.

If the STI timer expires while executing the I/O interrupt subroutine, execution immediately switches to the STI subroutine. When the STI subroutine is scanned to completion, execution resumes at the point that it left off in the I/O interrupt subroutine.

If two or more I/O interrupt requests are detected by the processor at the same instant, or while waiting for a higher or equal priority interrupt subroutine to finish, the interrupt subroutine associated with the specialty I/O module in the lowest slot number is scanned first. For example, if slot 2 (ISR 20) and slot 3 (ISR 11) request interrupt service at the same instant, the processor first scans ISR 20 to completion, then ISR 11 to completion.

## Status File Data Saved

Data in the following words is saved on entry to the I/O interrupt subroutine and re-written upon exiting the I/O interrupt subroutine.

- S:0 Arithmetic flags
- S:13 and S:14 Math register
- S:24 Index register

## I/O Interrupt Parameters

The I/O interrupt parameters below have status file addresses. They are described here.

- **ISR Number** - Specifies the subroutine file number that will be executed when an I/O interrupt is generated by an I/O module. The ISR Numbers are not part of the status file, but they are part of the I/O configuration for each slot in the SLC system.
- **I/O Slot Enables (Words S:11 and S:12)** - These words are bit mapped to the 30 I/O slots. Bits S:11/1 through S:12/14 refer to slots 1 through 30. Bits S:11/0 and S:12/15 are reserved.

The enable bit associated with an interrupting slot must be set when an interrupt occurs. Otherwise a major fault will occur. Changes made to these bits using the Data Monitor function take effect at the next end of scan.

- **I/O Interrupt Pending Bits (Words S:25 and S:26)** - These words are bit mapped to the 30 I/O slots. Bits S:25/1 through S:26/14 refer to slots 1 through 30. Bits S:25/0 and S:26/15 are reserved. The pending bit associated with an interrupting slot is set when the corresponding I/O slot interrupt enable bit is clear at the time of an interrupt request. It is cleared when the corresponding I/O event interrupt enable bit is set, or when an associated RPI instruction is executed. The pending bit for an executing I/O interrupt subroutine remains clear when the ISR is interrupted by a DII, STI, or fault routine.

*SLC 5/02 specific:* Likewise, the pending bit remains clear if interrupt service is requested at the time that a higher or equal priority interrupt is executing (fault routine, STI, or other ISR).

*SLC 5/03 and higher processors:* This bit is set if interrupt service is requested at the time a higher or equal priority interrupt is executing (fault routine, DII, STI, or other ISR).

- **I/O Interrupt Enables (Words S:27 and S:28)** - These words are bit mapped to the 30 I/O slots. Bits S:27/1 through S:28/14 refer to slots 1 through 30. Bits S:27/0 and S:28/15 are reserved. The enable bit associated with an interrupting slot must be set when the interrupt occurs to allow the corresponding ISR to execute. Otherwise the ISR will not execute and the associated I/O slot interrupt pending bit will be set.

*SLC 5/02 specific:* Changes made to these bits using the data monitor function or ladder instruction take effect at the next end of scan.

*SLC 5/03 and higher processors:* Changes made to these bits using the data monitor function or ladder instruction take effect immediately.

- I/O Interrupt Executing (Word S:32) - This word contains the slot number of the specialty I/O module that generated the currently executing ISR. This value is cleared upon completion of the ISR, run mode entry, or upon power up. You can interrogate this word inside of your DII or STI subroutine or fault routine if you wish to know if these higher priority interrupts have interrupted an executing ISR. You may also use this value to discern interrupt slot identity when multiplexing two or more specialty I/O module interrupts to the same ISR.

## I/O Interrupt Disable (IID) and I/O Interrupt Enable (IIE)

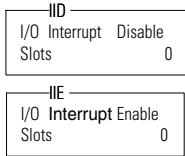

Fixed	SLC 5/01	SLC 5/02	SLC 5/03	SLC 5/04	SLC 5/05
		•	•	•	•

These instructions are generally used in pairs to prevent I/O interrupts from occurring during time-critical or sequence-critical portions of your main program or subroutine. The I/O Event-Driven Interrupt function is used with specialty I/O modules capable of generating an interrupt.

Use these instructions together to create a zone in your main ladder program file or subroutine file in which I/O interrupts cannot occur. Both instructions take effect immediately upon execution. You must specify a subroutine to be executed upon receipt of such an interrupt.

*SLC 5/02 specific:* Setting/clearing the I/O interrupt enable bits (S:27 and S:28) with a programming device or standard instruction such as MVM takes effect at the END of the scan only.

*SLC 5/03 and higher processors:* Setting/clearing the I/O interrupt enable bits (S:27 and S:28) with a programming device or standard instruction such as MVM takes effect immediately.

### IID Operation

When true, this instruction clears the I/O interrupt enable bits (S:27/1 through S:28/14) corresponding to the slots parameter of the instruction. Interrupt subroutines of the affected slots are not able to execute when an interrupt request is made. Instead, the corresponding I/O pending bits (S:25/1 through S:26/14) are set. The ISR is not executed until an IIE instruction with the same slot parameter is executed, or until the end of the scan during which you use a programming device to set the corresponding status file bit.



## IIE Operation

When true, this instruction sets the I/O interrupt enable bits (S:27/1 through S:28/14) corresponding to the slots parameter of the instruction. Interrupt subroutines of the affected slots regain the ability to execute when an interrupt request is made. If an interrupt was pending (S:25/1 through S:26/14) and the pending slot corresponds to the IIE slots parameter, the ISR associated with that slot executes immediately.

## IID/IIE Zone Example

In the program below, slots 1, 2, and 7 are capable of generating I/O interrupts. The IID and IIE instructions in rungs 6 and 12 are included to avoid having I/O interrupt ISRs execute as a result of interrupt requests from slots 1, 2, or 7. This allows rungs 7 through 11 to execute without interruption.

The first pass bit S:1/15 and the IIE instruction in rung 0 are included to insure that the I/O interrupt function is initialized following a power cycle. You should include a rung such as this any time your program contains an IID/IIE zone or an IID instruction.

The IID instruction in rung 6 clears the I/O interrupt enable bits associated with slots 1,2, and 7 (S:27/1, S:27/2, and S:27/7). The IIE instruction in rung 12 sets these same bits. If an I/O interrupt is detected by the processor while the processor is executing rungs 7-11, the interrupt will be marked as pending. (S:25/1, S:25/2, and/or S:25/7 will be set.) All interrupts marked as pending are serviced upon execution of rung 12. The lowest numbered slot is serviced first when multiple pending bits are set.

ISR execution will not occur between IID and IIE instructions.

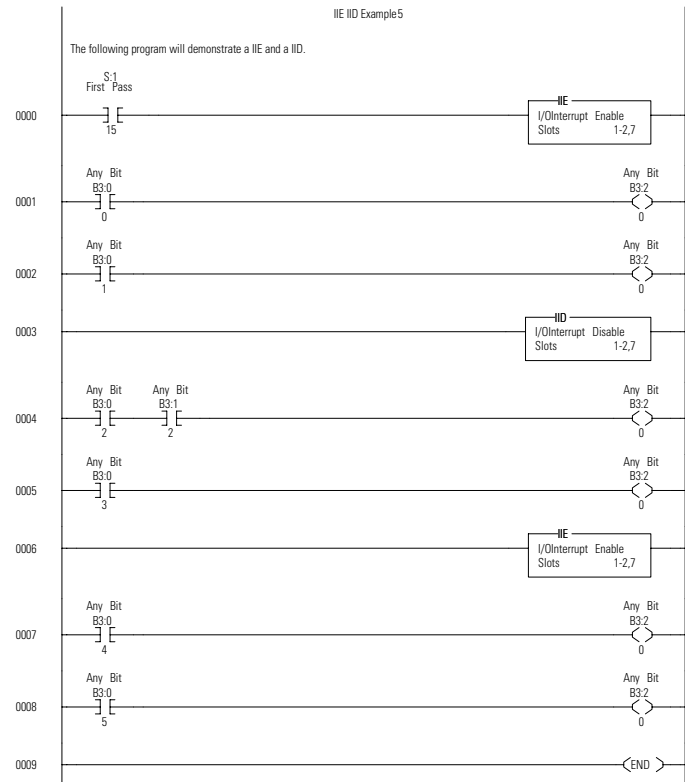

## Reset Pending Interrupt (RPI)

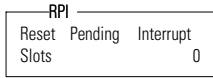

Fixed	SLC 5/01	SLC 5/02	SLC 5/03	SLC 5/04	SLC 5/05
		•	•	•	•

This instruction resets the pending status of the specified slots and informs the corresponding I/O modules that you have aborted their interrupt requests. This instruction is not required to configure a basic I/O interrupt application.

When true, this instruction clears the I/O pending bits (S:25/1 through S:26/14) corresponding to the slots parameter of the instruction. In addition, the processor notifies the specialty I/O modules in those slots that their interrupt request was aborted. Following this notice, the slot may once again request interrupt service. This instruction does *not* affect the I/O slot interrupt enable bits (S:27/1 through S:28/14).

### Entering Parameters

Enter the I/O slot numbers (1 to 30) involved.

**Table 11.5 I/O Slot Numbers**

Slot #	Slot Indicated
6	indicates slot 6
6,8	indicates slots 6 and 8
6 to 8	indicates slots 6, 7, and 8
1 to 30	indicates all slots

## Interrupt Subroutine (INT)

Fixed	SLC 5/01	SLC 5/02	SLC 5/03	SLC 5/04	SLC 5/05
		•	•	•	•

Use the INT instruction in I/O event-driven interrupt subroutines (ISRs) and STIs for identification purposes. Use of this instruction is optional.

This instruction has no control bits and is always evaluated as true. When used, the INT should be programmed as the first instruction of the first rung of the ISR.

## SLC Communication Instructions

This chapter contains general information about the SLC communication instructions. Each of the instructions includes information on:

- what the instruction symbol looks like.
- how to use the instruction.

**Table 12.1 Communication Instructions**

<b>Instruction Mnemonic</b>	<b>Instruction Name</b>	<b>Purpose</b>	<b>Page</b>
SVC	Service Communications	The SVC instruction interrupts the program scan to execute the service communication portion of the operating cycle.	12-3
MSG	Message Read/Write	This instruction transmits data from one node to another on the communication network.	12-5
CEM	ControlNet Explicit Message	This instruction transmits CIP generic commands to other ControlNet nodes via the 1747-SCNR.	12-45
DEM	DeviceNet Explicit Message	This instruction transmits CIP generic commands to other DeviceNet nodes via the 1747-SDN.	12-52
EEM	EtherNet/IP Explicit Message	This instruction transmits CIP generic commands to other EtherNet/IP nodes via channel 1.	12-58

## About the Communication Instructions

Use the SVC instruction to enhance communication performance of your processor. Use the various message instructions to send and receive data from other processors and devices.

In this chapter you will find a general overview preceding each type of instruction.

- Service Communication instruction for SLC 5/02 and higher processors.
- General message instruction for the SLC 5/02 and higher processors.
- ControlNet Explicit Message instruction for the SLC 5/03 and higher processors (requires series C, FRN 10 or higher OS firmware).
- DeviceNet Explicit Message instruction for the SLC 5/03 and higher processors (requires series C, FRN 10 or higher OS firmware).
- Ethernet/IP Explicit Message instruction for the SLC 5/05 processor (requires series C, FRN 10 or higher OS firmware).

## Service Communications (SVC)

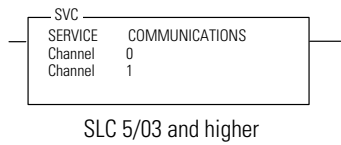

SLC 5/03 and higher

Fixed	SLC 5/01	SLC 5/02	SLC 5/03	SLC 5/04	SLC 5/05
		•	•	•	•

Output Instruction

### Use an SLC 5/02 Processor

The SVC instruction is an output instruction that has no programming parameters. When it is evaluated as true, the program scan is interrupted to execute the service communications part of the operating cycle. The scan then resumes at the instruction following the SVC instruction. Use this instruction to enhance the communication performance of your SLC 5/02 processor.

You are not allowed to place an SVC instruction in an STI interrupt, I/O interrupt, or user fault subroutine.

### Use SLC 5/03 and Higher Processors

When using SLC 5/03 and higher processors, the SVC instruction operates as described above. These processors also allow you to select a specific communication channel (0, 1, or both) to be serviced. You are not allowed to place an SVC instruction in a Fault, DII, STI, or I/O Event subroutine.

- SLC 5/03 processor
  - channel 0 is RS-232/DF1 Full-duplex, DF1 Half-duplex (master or slave), DF1 Radio Modem, DH-485, Modbus Remote Terminal Unit (RTU) Master<sup>(1)</sup>, or ASCII
  - channel 1 is DH-485
- SLC 5/04 processor
  - channel 0 is RS-232/DF1 Full-duplex, DF1 Half-duplex (master or slave), DF1 Radio Modem, DH-485, Modbus RTU Master<sup>(1)</sup>, or ASCII
  - channel 1 is DH+
- SLC 5/05 processor
  - channel 0 is RS-232/DF1 Full-duplex, DF1 Half-duplex (master or slave), DF1 Radio Modem, DH-485, Modbus RTU Master<sup>(1)</sup>, or ASCII
  - channel 1 is Ethernet

<sup>(1)</sup> SLC 5/03, SLC 5/04, SLC 5/05 OS Series C FRN 11 and above

The following status bits let you customize or monitor communications servicing.

**Table 12.2 Status Bits for Customizing Communication Servicing**

Channel 1		Channel 0 <sup>(1)</sup>	
S:2/5	Incoming Command Pending Bit	S:33/0	Incoming Command Pending Bit
S:2/6	Message Reply Pending Bit	S:33/1	Message Reply Pending Bit
S:2/7	Outgoing Message Command Pending Bit	S:33/2	Outgoing Message Command Pending Bit
S:2/15	Communications Servicing Selection Bit	S:33/5	Communications Servicing Selection Bit
S:33/7 <sup>(1)</sup>	Message Servicing Selection Bit	S:33/6	Message Servicing Selection Bit

<sup>(1)</sup> SLC 5/03 and higher processors only.

## Channel Servicing

Whether you select a channel to be serviced by the SVC instruction or not, that channel is still serviced normally at the end of the scan.

### TIP

You may program the SVC instruction unconditionally across the rungs. This is the normal programming technique for the SVC instruction.

## Message Instruction Overview

The message instruction is an output instruction that lets you read or write data from one processor to another processor via the communication channel(s). The SLC 5/02 processor can service one message instruction at any given time. The SLC 5/03 and higher processors can service up to four message instructions per channel at a time, for a maximum of eight message instructions at any given time. Only one message instruction is serviced at a time for Modbus RTU Master protocol.

To invoke the MSG instruction, toggle the MSG instruction rung from false-to-true. Do not toggle the rung again until the MSG instruction has successfully or unsuccessfully completed the previous message, indicated by the processor setting either the DN or ER bit.

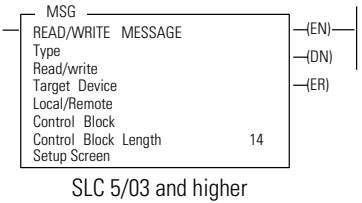
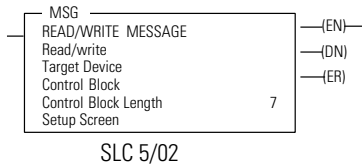

### MSG Instruction Operation

SLC 5/02 - Although only one message instruction can be serviced at a time, the processor may hold several messages enabled and waiting (control block status bits EN and EW set). Waiting messages are serviced one at a time in sequential order.

Fixed	SLC 5/01	SLC 5/02	SLC 5/03	SLC 5/04	SLC 5/05
		•	•	•	•

Output Instruction

Ladder logic should be included with every SLC 5/02 MSG instruction to time out the message in the event that the MSG starts transmitting successfully (MSG control block ST bit set), but the response is not received back in a reasonable amount of time. See Figure 12.1 and Figure 12.2 on how to use the MSG control block TO bit to accomplish this.

Figure 12.1 SLC 5/02 Messaging Example with MSG Timeout

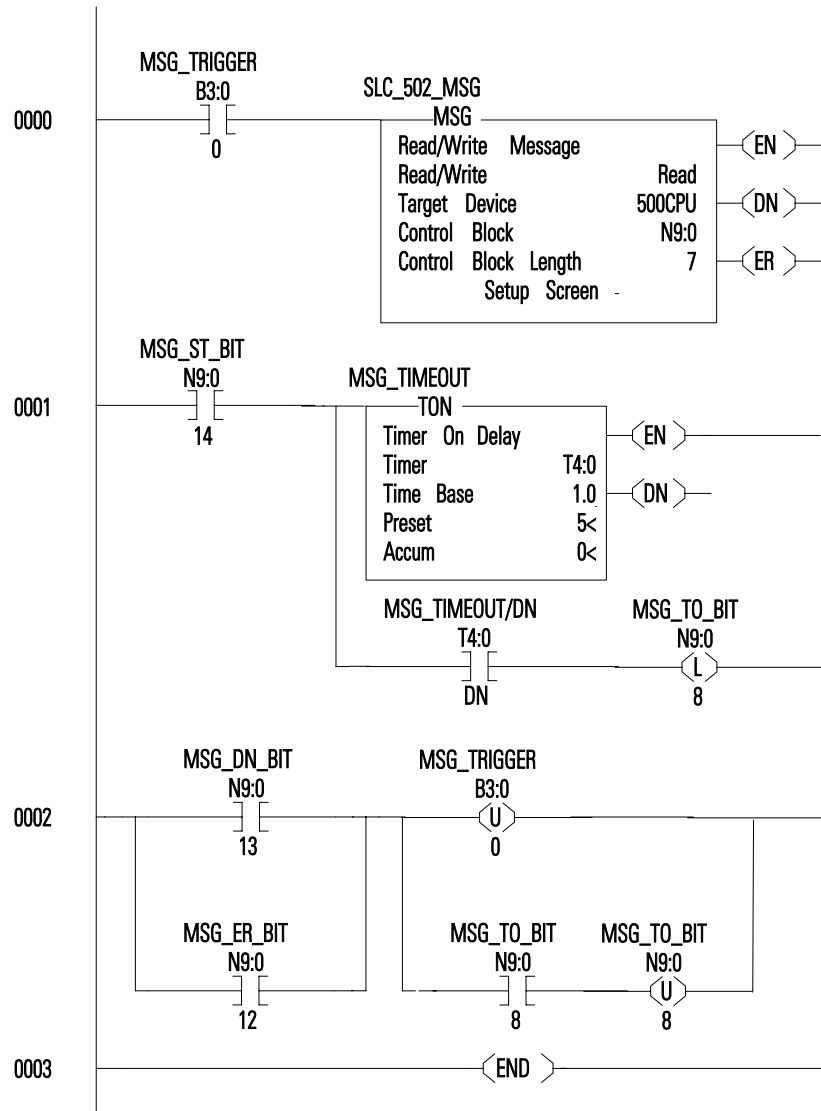



**Figure 12.2 SLC 5/02 Repeating Messaging Example with MSG Timeout**

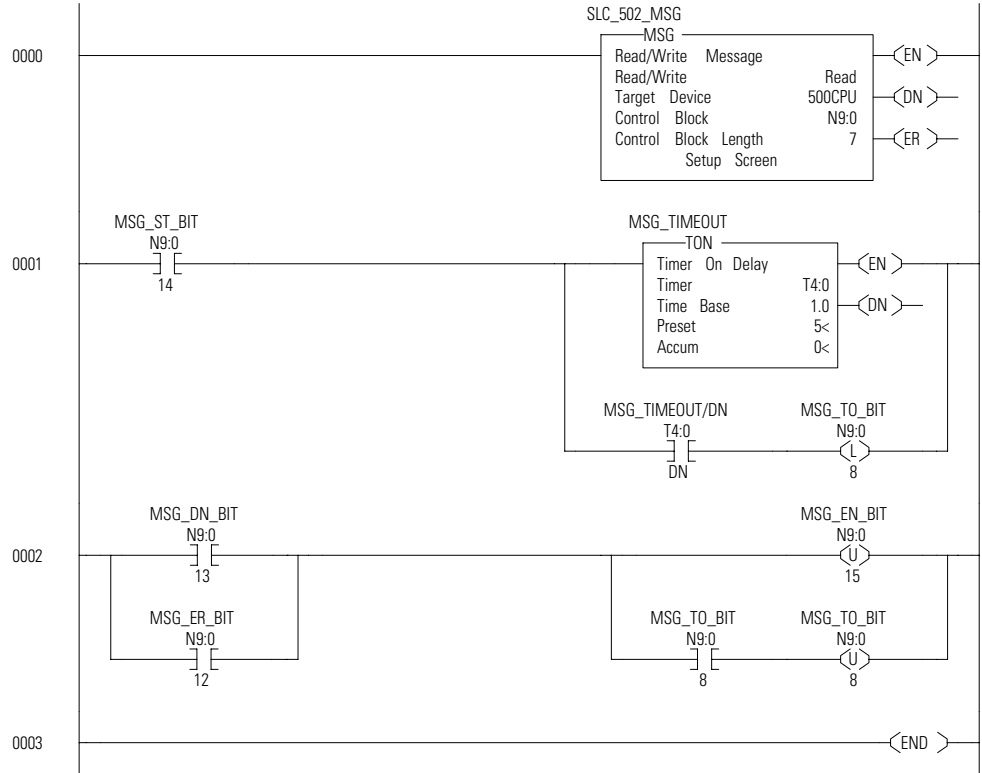

SLC 5/03 and higher - If a MSG instruction has entered one of the four channel dependent transmission buffers and is waiting to be transmitted, its control block will have status bits EN and EW set. If more than four MSG instructions for that channel are enabled at one time, a channel dependent overflow queue is used to store the MSG instruction header blocks (not the data for a MSG write) from the fifth instruction to the fourteenth. If the channel is configured for Modbus RTU Master, the second through the eleventh instructions will be added to a channel-dependent overflow queue. These instructions, queued in a FIFO order, will only have control block status bit EN set.

If more than 14 (11 for Modbus RTU Master) MSG instructions are enabled at one time for any one channel, only control block status bit WQ is set, as there is no room available to currently queue the instruction. This instruction must be re-scanned with true rung conditions until space exists in the overflow queue.

**TIP**

If you consistently enable more MSG instructions than the buffers and queues can accommodate, the order in which MSG instructions enter the queue is determined by the order in which they are scanned. This means MSG instructions closest to the beginning of the program enter the queue regularly and MSG instructions later in the program may not ever enter the queue.

You can use the timeout control similar to the SLC 5/02 MSG instruction or use the built in timeout control (recommended). If the timeout value is set to 0, the functionality is similar to the SLC 5/02 MSG instruction. It differs in that once the TO bit is set, it will be reset automatically along with the ER bit on the next MSG rung false-to-true transition. We highly recommend setting the internal timeout value to something other than zero.

**Figure 12.3 SLC 5/03, SLC 5/04, and SLC 5/05 Non-repeating**

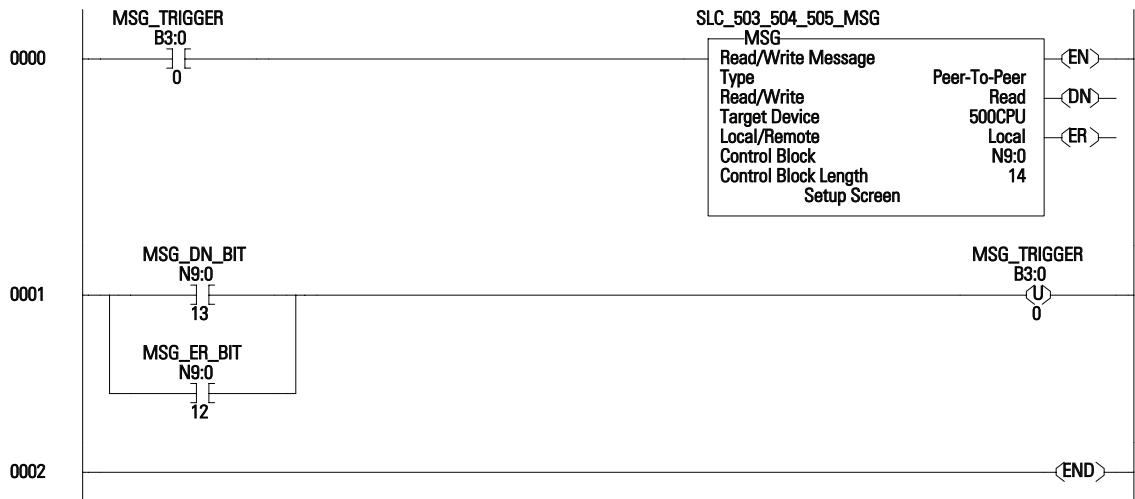
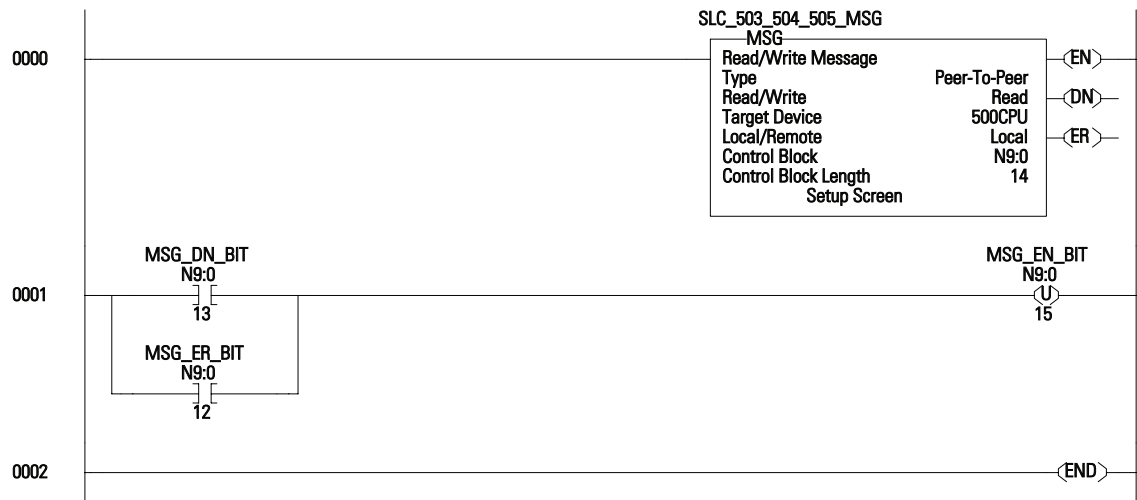

Figure 12.4 SLC 5/03, SLC 5/04, and SLC 5/05 Repeating Messaging Example



For the SLC 5/05 Channel 1 Ethernet, TCP/IP protocol is used to establish Ethernet connections, in order to send the MSG commands. Connections can be initiated by either a client program (INTERCHANGE or RSLinx application) or a processor.

The client program or processor must first establish a connection to the SLC 5/05 to enable the SLC 5/05 to **receive** solicited messages from a client program or another processor (incoming connection). The client program must also establish a connection to the SLC 5/05 to enable the SLC 5/05 to **send** unsolicited messages to a client program (outgoing connection).

To send a peer message, the SLC 5/05 must first establish a connection with the destination node at a specified IP address on the Ethernet network. A connection is established when a MSG instruction executes and no previous connection to the same device exists. When a MSG instruction executes, the SLC 5/05 checks to see whether a connection has been established with the destination node. If a connection has not been established, the SLC 5/05 attempts to establish a connection of the peer type.

**Table 12.3 Dedicated Connections**

<b>Number of Connections<sup>(1)</sup></b>	<b>Dedicated to:</b>
4	peer messages (outgoing)
4	client messages (incoming)
8 <sup>(2)</sup> , 16 <sup>(3)</sup> , 24 <sup>(4)</sup> , 40 <sup>(5)</sup> , 56 <sup>(6)</sup>	either peer or client messages

<sup>(1)</sup> Connections established by an INTERCHANGE client, RSLinx client, and peers are all included when counting the number of connections

<sup>(2)</sup> All series A/B 16 K (1747-L551) processors and series A/B 32 K (1747-L552) and 64 K (1747-L553) processors with OS 501, series C, FRN 4 and lower firmware.

<sup>(3)</sup> Series A/B 32 K (1747-L552) and 64 K (1747L553) processors with OS 501, series C, FRN 5 and higher firmware.

<sup>(4)</sup> Series C 16 K (1747-L551) processors.

<sup>(5)</sup> Series C 32 K (1747-L552) processors.

<sup>(6)</sup> Series C 64 K (1747-L553) processors.

**IMPORTANT**

For peer connections, no more than one connection per destination node is established. If multiple MSG instructions use the same destination node, they share the same connection.

## MSG Instruction Configuration Options

The following configuration options are available on all SLC 5/02 and higher processors.

- Peer-to-peer Read/Write on a local network to another SLC 500 processor
- Peer-to-peer Read/Write on a local network to a 485CIF device (PLC-2 emulation)

In addition, the following configuration options are available on all SLC 5/03 and higher processors.

- Peer-to-peer Read/Write on a local network to a PLC-5 processor
- Peer-to-peer Read/Write on a remote network to another SLC 500 processor
- Peer-to-peer Read/Write on a remote network to a 485CIF device (PLC-2 emulation)
- Peer-to-peer Read/Write on a remote network to a PLC-5 processor
- Peer-to-peer Read/Write on a local network to Modbus slave devices

In addition, the following configuration option is available on SLC 5/05 processors.

- Peer-to-peer Read/Write Multihop from Ethernet to a Logix processor (ControlLogix, FlexLogix, and CompactLogix), or other EtherNet/IP device, or through ControlLogix gateway to ControlNet, DH+, or DH-485.

## MSG Instruction Parameters

Enter the following parameters when programming this instruction.

- **Read/Write** - Read indicates the local processor (processor in which the instruction is located) is receiving data; write indicates the local processor is sending data.
- **Target Device** identifies the type of device which responds to the MSG command. Valid options are:
  - 500CPU, if the target device is another SLC processor
  - 485CIF, if the target device is a PLC-2 emulator device
  - PLC-5, if the target device accepts PLC-5 commands<sup>(1)</sup>
  - Modbus, if the target device is configured as Modbus RTU Slave

<sup>(1)</sup> SLC 5/03 and higher only.

- **Local or Remote** identifies if the message is sent to a device on a local network, or to a remote device on another network through a bridge. Valid options are:
  - Local, if the target device is on the local network
  - Remote, if the target device is on a remote network<sup>(1)</sup>
- **Control Block** is an integer file address that you select. It is a block of words, containing the status bits, target file address, and other data associated with the message instruction.
- **Control Block Length** is a display-only field that indicates how many integer file words are being used by the control block.

See Table 12.4 for possible control block lengths.

**TIP**

The MSG control block length increases from 7 to at least 14 words when changing from an SLC 5/02 to an SLC 5/03, SLC 5/04, or SLC 5/05 processor program. For ease of program portability between SLC processors, dedicate an integer file to each MSG instruction control block.

**Table 12.4 MSG Instruction Control Block Lengths**

	<b>485 CIF</b>	<b>500 CPU</b>	<b>PLC-5</b>	<b>PLC-5 with Logical ASCII/Symbolic Addressing</b>	<b>Modbus RTU Master</b>
SLC 5/02	7	7	Not Applicable	Not Applicable	Not Applicable
SLC 5/03	14	14	14	56 <sup>(1)</sup>	14 <sup>(3)</sup> (Channel 0 only)
SLC 5/04	14	14	14	56 <sup>(2)</sup>	14 <sup>(3)</sup> (Channel 0 only)
SLC 5/05 Channel 0	14	14	14	56	14 <sup>(3)</sup>
SLC 5/05 Channel 1	51	51	51	93	Not Applicable

<sup>(1)</sup> OS302, Series C, FRN 5 or higher with RSLogix 500 version 4.5 or higher.

<sup>(2)</sup> OS401, Series C, FRN 5 or higher with RSLogix 500 version 4.5 or higher.

<sup>(3)</sup> Series C, FRN 11 or higher with RSLogix 500 version 8.10 or higher.

## MSG Instruction Setup Screen Parameters

### Parameters for This Controller

- Data Table Address
  - For a Read, this is the starting address which receives the data that is read from the target device.
  - For a Write, this is the starting address of the data which is written to the target device.
  - For Modbus RTU Master, this is the starting address to receive or send data.
- Size in Elements
  - Specifies the length of the message in elements. The maximum number of elements that are transferred via a MSG instruction is determined by the size of the destination data type.
  - For a Read, the data type in the local processor determines the maximum number of elements.
  - For a Write, the data type in the target device determines the maximum number of elements. The maximum number of elements that are transferred may be further limited based on the processor type.

**Table 12.5 MSG Instruction Maximum Number of Elements (except Modbus RTU)**

File Types	SLC 500, SLC 5/01, SLC 5/02	SLC 5/03, SLC 5/04, SLC 5/05 Channel 0	SLC 5/05 Channel 1		
			Non-Multihop	Multihop to SLC	Multihop to PLC-5
O, I, B, N	41	103	256	119	115
T	13	34 <sup>(1)</sup>	256 <sup>(3)</sup>	39	38 <sup>(4)</sup>
C, R	13	34	256	39	38
F	Not Applicable	51	256	59	57
St	Not Applicable	2 <sup>(2)</sup>	25	2	1
A	Not Applicable	103	256	119	115

<sup>(1)</sup> PLC-5 type timer element maximum is 20.

<sup>(2)</sup> PLC-5 type string element maximum is 1.

<sup>(3)</sup> PLC-5 type timer element maximum is 208.

<sup>(4)</sup> PLC-5 type timer element maximum is 23.

**Table 12.6 MSG Instruction Maximum Number of Elements for Modbus RTU Master**

File Types	Channel 0 on SLC 5/03, SLC 5/04, SLC 5/05
B	1856 bits
N	116 words
F	58 registers (32-bit)

- Channel<sup>(1)</sup>

Specifies the communication channel that is used to transmit the message request.

- SLC 5/03 - (Channel 0, RS-232) or (Channel 1, DH-485)
- SLC 5/04 - (Channel 0, RS-232) or (Channel 1, DH+)
- SLC 5/05 - (Channel 0, RS-232) or (Channel 1, Ethernet)

*Parameters for Target Device (except Modbus RTU)*

- Message Timeout<sup>(2)</sup>

Specifies the length of the message timer in seconds. A timeout of 0 seconds means that there is no timer and a message that has been acknowledged waits indefinitely for a reply. Valid range is 0, 1 to 255.

Message Timeout for a channel 0 DF1 Full-duplex MSG instruction should be configured greater than the channel 0 [ACK Timeout x (ENQ Retries + 1)] in seconds.

Message Timeout for a channel 0 DF1 Half-duplex Master MSG instruction with polling mode set to 'message based' should be configured greater than the channel 0 [ACK Timeout x (2 x Message Retires + 1)] in seconds.

Message Timeout for a channel 0 DF1 Half-duplex Master MSG with polling mode set to standard should be configured greater than the channel 0 [ACK Timeout x (Message Retires + 1) x number of slave stations] in seconds.

Message Timeout for a channel 0 DF1 Half-duplex Slave MSG should be configured greater than the Master's channel 0 [2 x ACK Timeout x (message retries + 1) x number of slave stations] in seconds.

<sup>(1)</sup> SLC 5/03 and higher only.

<sup>(2)</sup> SLC 5/03 and higher only.



Message Timeout for any SLC 5/05 channel 1 MSG cannot be modified in the Ethernet Message Setup dialog box. It is assigned by the processor and is determined by adding the Channel 1 MSG Connection Timeout to the MSG Reply Timeout, then adding five seconds. This value can be modified by changing one or both of the timeout values in the channel 1 channel configuration screen. The modified message timeout applies to all MSG instructions.

- Data Table Address<sup>(1)</sup>
  - For a Read, this is the starting address where the data is being read from.
  - For a Write, this is the starting address where the data is being written to.
  - To enter in a PLC-5 type logical ASCII address, begin the address name with a \$ and enclose the name in double quotes (example: '\$N7:0'). To enter in a PLC-5 type symbolic address, enclose the name in double quotes (example: 'READ\_TAG').

#### TIP

You may use the PLC-5 type symbolic address to read/write controller tags in Logix controllers. The supported address forms are:

- tag\_name.
- tag\_name[x].
- tag\_name[x,y] or tag\_name[x][y].
- tag\_name[x,y,z] or tag\_name[x][y][z].

Use INT data type for integer files or REAL data type for floating point files.

- Data Table Offset<sup>(2)</sup>

Specifies the word offset into an SLC 500 or MicroLogix Common Interface File (CIF) or byte offset into a PLC-5 or Logix PLC-2 compatibility file. Valid range is 0 to 255.

- Local Node Addr (dec)/(oct)<sup>(3)</sup> <sup>(4)</sup>

<sup>(1)</sup> 500 CPU and PLC-5 Target Devices only.

<sup>(2)</sup> 485 CIF Target Devices only.

<sup>(3)</sup> Local MSG only.

<sup>(4)</sup> All processors except SLC 5/05 Channel 1.

Specifies the node number of the target device that is receiving the message.

**Table 12.7 Valid Range of Local Node Address, Local Bridge Address, and Remote Station Address Parameters**

Protocol	Decimal	Octal
DH-485	0-31	0-37
DH+	0-63	0-77
DF1	0-254	0-376

Processors running OS Series C, FRN 6 and higher, can execute a broadcast write MSG command by entering in a target device local node address of 255 (decimal) using RSLogix 500 version 5.20 or higher. A broadcast write command is executed simultaneously by every node that receives it, but no node acknowledges or responds to it. The broadcast write command is valid for DH-485 and DF1 networks only. Broadcast is not supported for read commands or any remote messages.

- Ethernet (IP) Address <sup>(1)</sup>

Specifies the Ethernet IP address of the target device that is receiving the message. When using OS501, Series C, FRN 5, or higher firmware and RSLogix 500 version 5.20, or higher programming software, you may optionally enter in the device name (as defined on your local network's Domain Name System (DNS) servers), in place of the target device's Ethernet IP address. (RSLogix 500 versions 6.30 and below place an additional restriction on the device name that it must start with an alpha character A to Z.) This device name must be no longer than 41 characters. You must have a Primary Name Server and/or Secondary Name Server defined in the Channel 1 Ethernet configuration to successfully use this device name functionality. If you have a Default Domain Name defined in the Channel 1 Ethernet configuration, then the Default Domain Name is appended to the device name when requesting the corresponding IP address from the DNS server.

- MultiHop<sup>(2)</sup>

Specifies whether or not the message is either routed to an EtherNet/IP device, such as a Logix controller or an Ethernet Network interface (1761-NET-ENI), or through a ControlLogix gateway (1756-ENBT). If yes, then the target device Ethernet address or MSG route must be configured in the MultiHop tab of the MSG Setup Screen.

Refer to page 12-26 for more information.

<sup>(1)</sup> SLC 5/05 channel 1 only; no Multihop.

<sup>(2)</sup> SLC 5/05 channel 1 only.

- Local Bridge Addr (dec)/(oct)<sup>(1)</sup> <sup>(2)</sup>

Specifies the node number of the bridge device on the local network.

Refer to page 12-16 for the valid range of addresses.

- Remote Bridge Addr (dec)<sup>(1)</sup>

Specifies the node number of the bridge device on the bridging network, when the bridge is configured for gateway mode. Otherwise, leave at 0.

- Remote Station Addr (dec)<sup>(1)</sup>

Specifies the node number of the target device on the remote network.

Refer to page 12-16 for the valid range of addresses.

- Remote Bridge Link ID<sup>(1)</sup>

Specifies the link ID of the remote network where the target device resides. Valid range is 0 to 255.

### *Parameters for Target Device (Modbus RTU)*

The screenshot shows a configuration window titled "MSG - Rung #2:0 - N7:0" with a "General" tab. The window is divided into several sections:

- This Controller:**
  - Modbus Command: 01 Read Coil Status (0xxxxx)
  - Data Table Address: B3.5/2
  - Size in Elements: 1
  - Channel: 0
- Target Device:**
  - Message Timeout: 2
  - MB Data Address (1-65536): 25
  - Slave Node Address (dec): 16
  - Modbus Address: 25
- Control Bits:**
  - Ignore if timed out (TO): 0
  - Awaiting Execution (EW): 0
  - Error (ER): 0
  - Message done (DN): 0
  - Message Transmitting (ST): 0
  - Message Enabled (EN): 0
  - Waiting for Queue Space: 0
- Error:**
  - Error Code(Hex): 0
- Error Description:**
  - No errors

<sup>(1)</sup> Remote MSG only.

<sup>(2)</sup> All processors except SLC 5/05 Channel 1.

- Data Table Address

This variable defines the starting address in the local controller. Valid file types for the Data Table Address are shown below:

**Table 12.8 Valid File Types for Data Table Address**

Message Read	Message Write
Bit (B)	Bit (B)
Integer (N)	Integer (N)
Floating Point (F)	Floating Point (F)

Only Bit (B) and Integer (N) file types are valid for Modbus Command messages. Starting data table address for coil/input bit commands (1, 2, 5, and 15) require a bit address. Starting data table addresses for register commands (3, 4, 6, and 16) require a word address.

Floating Point (F) file type is valid for Modbus Command messages for Holding Registers (commands 03, 06 and 16) when data is configured for 32 bits.

- Size in Elements

This variable defines the amount of data (in elements) to exchange with the target device. The maximum amount of data that can be transferred via an MSG instruction is 116 words for Modbus commands and is determined by the destination data type.

The destination data type is defined by the type of message: read or write. When a read message is used, the destination file is the data file in the local or originating processor. When a write message is used, the destination file is the data file in the target processor.

**TIP**

Input, output, string, and RTC file types are not valid for read messages.

The maximum number of elements that can be transmitted or received are shown in the following table.

**TIP**

The table is not intended to illustrate file compatibility. It only illustrates the maximum number of elements that can be exchanged in each case.

<b>Message Type</b>	<b>File Type</b>	<b>Element Size</b>	<b>Maximum Number of Elements per Message</b>
Modbus Commands	B, N (command 5)	1-bit	1
	B, N, F (command 6)	1-word or 32-bit register (float file type)	1
	B, N (commands 1, 2, and 15)	1-bit	1856 Modbus bit elements (116 words) Commands 1 and 2 are read-only, command 15 is write-only.)
	B, N, F (commands 3 and 16) B, N (command 4)	multi-register	116 16-bit Modbus register elements (or 58 32-bit Modbus register elements)

Modbus RTU Master protocol is implemented with support for 32-bit registers.

When Modbus command 3, 4, 6 or 16 is selected, a selector for register size appears. There are two different word orders for 32-bit registers. For example, a value of aabbccdd h may be represented as:

- aabb ccdd h, or
- ccdd aabb h

To support different processors and file types, the word-swap option for 32-bit registers is made available.

#### **TIP**

When reading and writing with 32-bit registers, verify with RSLogix 500 if the value appears as intended after the transfer. Toggle word-swap if necessary.

Word-swap is required when reading and writing to Float file type with another MicroLogix processor.

Here are two examples of Read Register commands.

**Example 1: A 32-bit Read Request for an Integer (N) command**

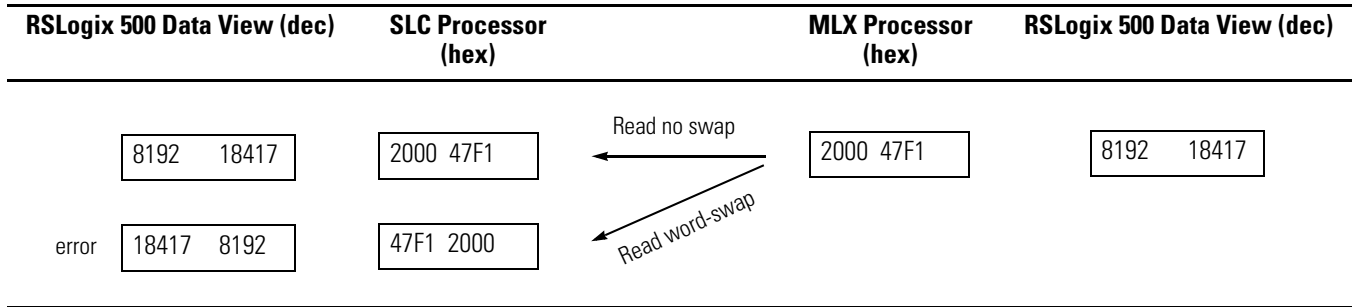

**Example 2: A 32-bit Read Request for an Float (F) command**

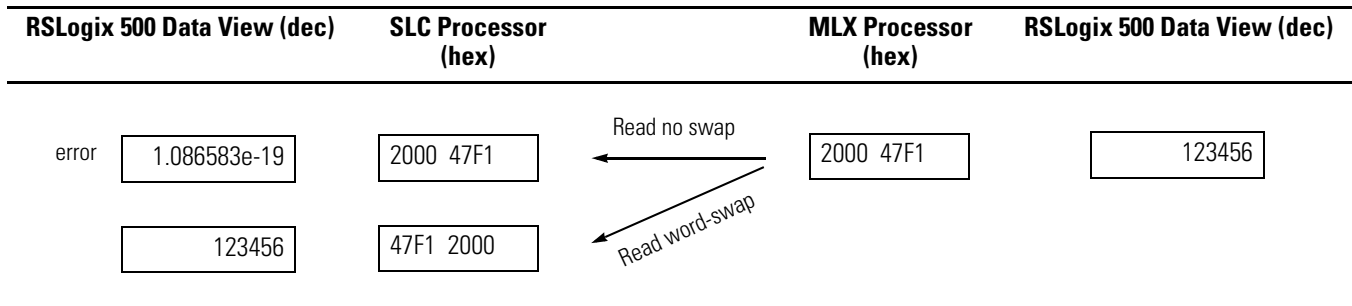

Note the format differences between Float File and Integer File.

- If the destination is Floating File (Example 1), word-swap may be necessary.
- If the destination is Integer File (Example 2), word-swap may not be necessary.

Here, it is assumed the peer device has not already swapped the word order in the reply. You need to validate the word order by checking the received value in RSLogix 500, prior to implementation on the network.

Here are two examples of Write Register commands.

**Example 3: A 32-bit Write Request for an Integer (N) command**

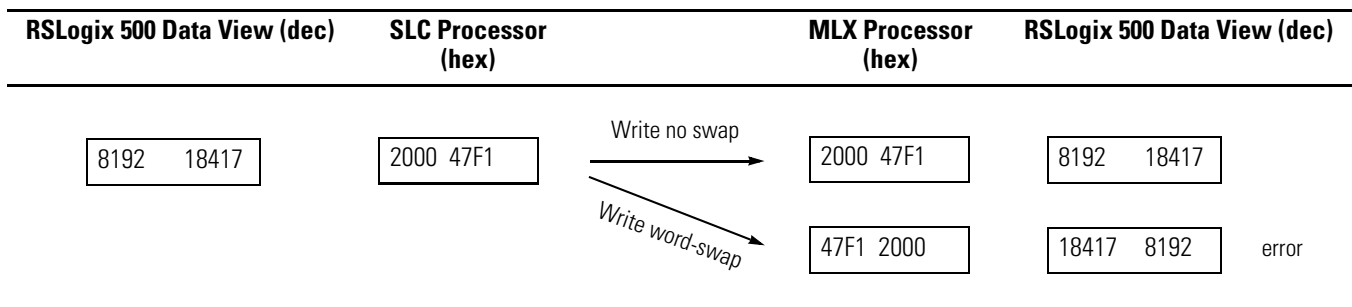

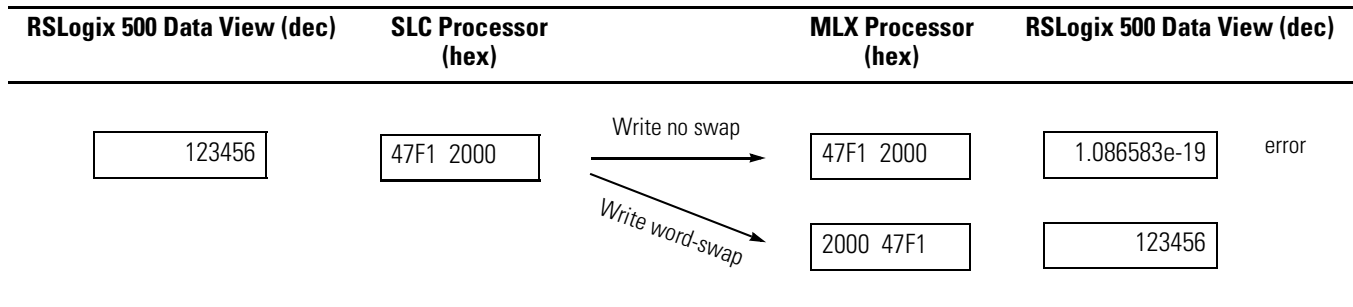
**Example 4: A 32-bit Write Request for a Float (F) command**

Similar to the Read Register command,

- If the source file is a Floating file (Example 3), word-swap is recommended.
- If the source file is an Integer file (Example 4), word-swap is unnecessary.

Here, it is assumed the peer device does not swap received word order. You need to validate the word order prior to implementation on the network.

**IMPORTANT**

Since a 32-bit register is not defined in the Modbus protocol specification, you are advised to first test if the word order is decoded correctly. Some devices may require word-swap and others may not.

RSLogix and SLC firmware do not determine word order based on element file type. You need to specify if a 32-bit word-swap is desired.

- Channel

FRN 11 of SLC 5/03, SLC 5/04, and SLC 5/05 supports Modbus RTU Master on Channel 0 only. Channel 0 is the RS-232 port.

- Message Timeout

This value defines how long, in seconds, the message instruction has to complete its operation once it has started. Timing begins when the false-to-true rung transition occurs, enabling the message. If the timeout period expires, the message instruction will generate a specific error (see MSG Instruction Error Codes on page 12-41). The amount of time that is acceptable should be based on application requirements and network capacity and loading. The default value is 2 seconds for Modbus commands. The maximum timeout value is 255 seconds.

If the message timeout is set to zero, the message instruction will never timeout. Set the Time Out bit (TO = 1) to flush a message instruction from its buffer if the destination device does not respond to the communications request.

- Modbus - MB Data Address (1-65536)

Modbus addressing is limited to 16 bits per memory group, each with a range of 1 to 65,536. There are four memory groups, one for each function:

- coils (generally addressed as 0xxxx)
- contacts (1xxxx)
- input registers (3xxxx)
- holding registers (4xxxx)

Coils and contacts are addressed at the bit level. Coils are outputs and can be read and written. Contacts are inputs and are read-only.

Input registers and holding registers are addressed at the word level. Input registers are generally used for internally storing input values. They are read-only. Holding registers are general purpose and can be both read and written.

The most significant digit of the address is considered a prefix, and does not get entered into the MB Data Address field when configuring the message instruction.

When the message is sent, the address is decremented by 1 and converted into a 4-character hex number to be transmitted via the network (with a range of 0-FFFFh); the slave increments the address by 1, and selects the appropriate memory group based on the Modbus function.

**TIP**

Modbus protocol may not be consistently implemented in all devices. The Modbus specification calls for the addressing range to start at 1; however, some devices start addressing at 0.

The Modbus Data Address in the Message Setup Screen may need to be incremented by one to properly access a Modbus slave's memory, depending on that slave's implementation of memory addressing.

- Slave Node Address

This is the destination device's node number if the devices are on a Modbus network.



The default Slave Node Address is 1. The range is 0 to 247. Zero is the Modbus broadcast address and is only valid for Modbus write commands (5, 6, 15 and 16).

**TIP**

To initiate a broadcast message on a Modbus network, set the slave node address to 0. Do not initiate more than one Modbus broadcast message at a time. When sequentially triggering multiple Modbus broadcast messages, insert at least 10 msec. delay in between each message.

- Modbus Address

This is the translated Modbus address from the MB Data Address.

### *Configure a Modbus Message*

This section describes how to configure a local message using the Modbus communication commands. Since configuration options are dependent on which channel is selected, the programming software has been designed to only show the options available for the selected channel.

Before configuring the MSG instruction, open the Channel Configuration screen and set the Driver to Modbus RTU Master. For more information on Channel Configuration, see *Configuring a Channel for Modbus RTU Master* on page 13-91.

**Figure 12.1 Message Setup Screen**

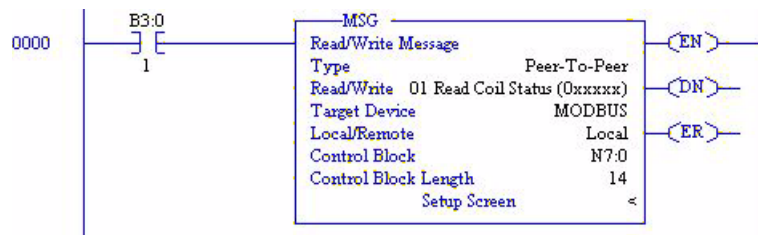

Rung 0 shows a standard RSLogix 500 message (MSG) instruction preceded by conditional logic.

1. Double-click Setup Screen to access the message setup screen.
2. The RSLogix 500 Message Setup Screen appears. This screen is used to setup or monitor message parameters for “This Controller”, “Target Device”, and “Control Bits”. Descriptions of each of these sections follow.

Figure 12.2 “This Controller” Parameters

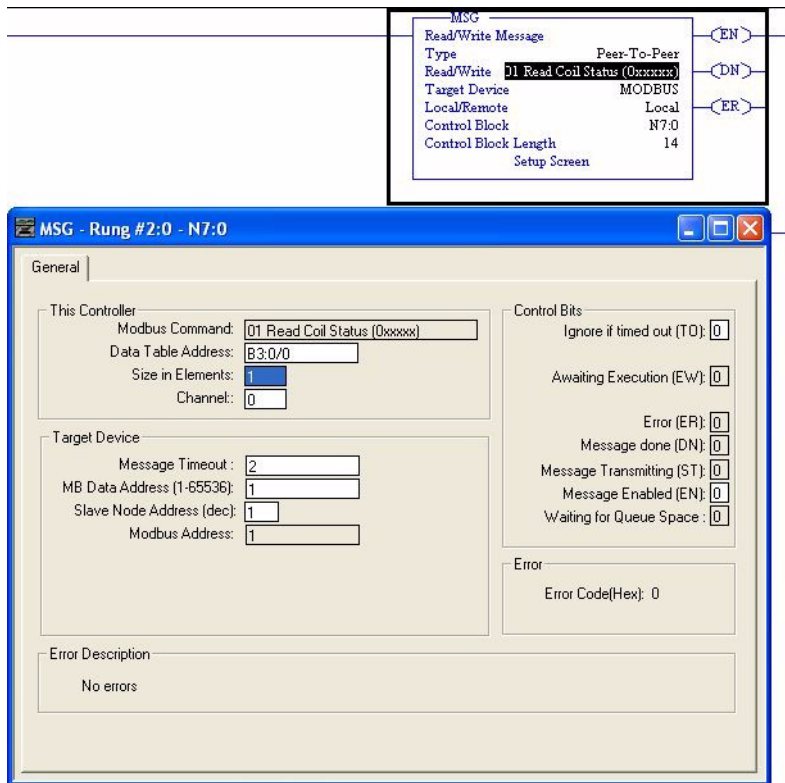

*Modbus Command*

Modbus command is configured at rung setup. If a Channel configured for Modbus Master is selected in the Channel field of the Message Setup Screen, the following Modbus Command options will become available.

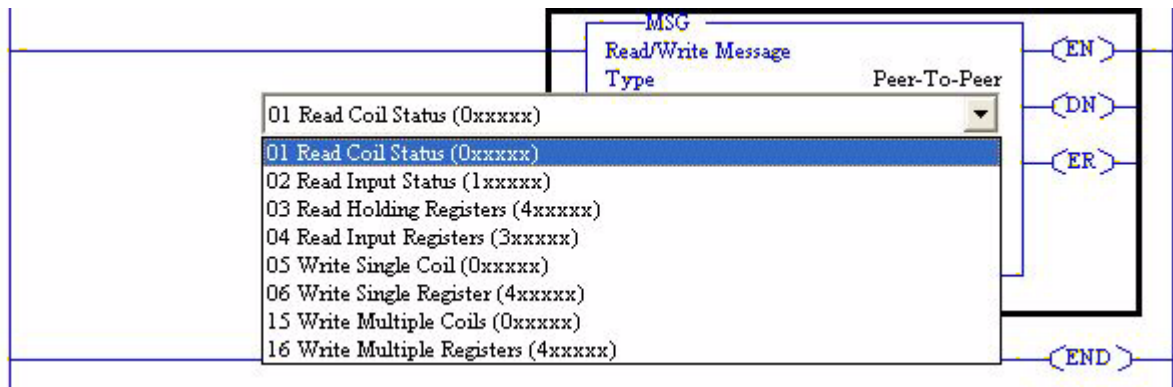

The controller supports eight Modbus commands. If the target device supports any of these Modbus command types, the controller should be

capable of exchanging data with the device. Supported Modbus commands include:

**Modbus Command Types**

<b>Modbus Command</b>	<b>Used For</b>
01 Read Coil Status	reading bits
02 Read Input Status	reading bits
03 Read Holding Registers	reading words
04 Read Input Registers	reading words
05 Write Single Coil	writing 1 bit
06 Write Single Register	writing 1 word
15 Write Multiple Coil	writing multiple bits
16 Write Multiple Registers	writing multiple words

### *Configure MultiHop Tab*

To message to an Ethernet Network Interface (ENI) or MicroLogix 1100, enter the target device's IP address in the first row 'To Address' field.

To message to a CompactLogix, ControlLogix, or FlexLogix controller, enter the controller's Ethernet interface IP address in the first row 'To Address' field, press the keyboard insert key to add a hop (which appends a second row labeled ControlLogix Backplane) and enter the controller's backplane slot number (0 to 16 for ControlLogix, always 0 for CompactLogix and FlexLogix) in the second row 'To Address' field.

To message through a ControlLogix gateway to ControlNet, DH+, or DH-485, enter the slot number of the desired network interface module in the second row 'To Address' field, press the keyboard insert key to add another hop (which appends a third row), select the appropriate 'From Device' and 'From Port' (if applicable) and enter the node address in 'To Address' field.

Some message routes may require adding additional hops. Not all message routes entered with the software are valid. The software validates the construct of the message route when the rung is verified.

## MSG Instruction Setup Screen Status Bits

The column in the table below lists the various status bits associated with the SLC 500 MSG instruction as displayed in the RSLogix 500 MSG instruction setup screen.

**Table 12.9 MSG Instruction Setup Screen Status Bits**

Bit Definition	Bit Mnemonic	Bit Address
Ignore if timed out	TO	08
To be retried	NR	09
Awaiting execution	EW	10
Continuous run	CO	11
Error	ER	12
Message done	DN	13
Message transmitting	ST	14
Message enabled	EN	15
Waiting for queue space	WQ	07

- Timeout Bit TO (word 0, bit 8): Set this bit in your application to remove an active message instruction from processor control. You must use your own timeout control routine for the SLC 5/02 MSG instruction (See Figure 12.1 on page 12-6). You may use the internal timeout control for SLC 5/03 and higher processors. For these processors, we recommend using the built-in timeout control because it simplifies the user program. Default values are 5 seconds for SLC 5/03, SLC 5/04, and SLC 5/05 channel 0, and 23 seconds for SLC 5/05 channel 1.

To utilize the internal timeout control, a value greater than 0 must be entered for the MSG instruction timeout parameter. A timeout value of 0 means no timeout value. In other words, if communication is interrupted, the processor will wait forever for a reply. If an acknowledgement is received (as indicated by the ST bit being set), but the reply is not received, the MSG instruction will appear to be locked up, although it is merely waiting for the reply.

When a value greater than 0 is entered for the MSG timeout parameter and communication is interrupted, the MSG instruction will timeout and error after the time expires, allowing the user program to retry the same message if desired.

With an SLC 5/02 MSG instruction, the ladder logic must reset the Timeout Bit before triggering the MSG instruction.

**TIP**

When programming timeout control in SLC 5/03 and higher processors, omit the Timeout Bit manual reset rung.

- No Response Bit NR (bit 9) is set if the target processor responds to the MSG instruction that it cannot process the message at the current time (for DH-485 and DH+ protocols only). This means that the MSG should be retried. The NR bit is reset the next time the MSG instruction gets scanned. Do not set or reset this bit. It is informational only.
- Enabled and Waiting Bit EW (bit 10) is set after the enable bit is set and the message is physically placed in one of the four available transmit buffers. The EW bit is reset when either the ST or ER bit is set. Do not set or reset this bit. It is informational only.
- Continuous Operation CO (bit 11)<sup>(1)</sup> Set this bit if you wish to continually resend the MSG instruction. We recommend that internal timeout control be used for this option and the rung be unconditionally true. Use this bit to turn the mode on and off. A MSG instruction occupies one of the four channel transmission buffers when its CO bit is set. Therefore, a maximum of four MSG instructions per channel may have their CO bit set.

This mode will continuously operate provided that the rung is continually scanned. If the instruction errors prior to the MSG timeout, it will automatically retry until it is successful. If the instruction errors due to a MSG timeout, the MSG stops triggering. The EN bit must be toggled off and back on to resume operation.

**TIP**

If your program contains four message instructions assigned to the same channel with the Continuous Operation (CO) bit set, no other message instructions can be executed out that same channel, including message instructions which may be in the fault routine.

- Error Bit ER (bit 12) is set when message transmission has failed. The ER bit is reset the next time the associated rung goes from false to true. Do not set or reset this bit. It is informational only.
- Done Bit DN (bit 13) is set when the message is transmitted successfully. The DN bit is reset the next time the associated rung goes from false to true. Do not set or reset this bit. It is informational only.

<sup>(1)</sup> SLC 5/03 and higher processors only.

- Start Bit ST (bit 14) is set when the processor receives acknowledgment (ACK) from the target device. The ST bit is reset when the DN, ER, or TO bit is set. Do not set or reset this bit. It is informational only.

For SLC 5/05 Ethernet (channel 1) communications, the ST bit indicates internally that the Ethernet daughterboard has received a command and it is acceptable for a transmission attempt. The command has not yet been transmitted.

For all broadcast message writes, and for DF1 Radio Modem communications, the ST bit only indicates that the command has been successfully transmitted.

- Enable Bit EN (bit 15) is set when rung conditions go true and there is space available in either the MSG buffer or MSG queue. It remains set until message transmission is completed and the rung goes false. You may reset this bit once either the ER or DN bit is set in order to retrigger a MSG instruction with true rung conditions on the next scan. Do not set this bit.
- Waiting for Queue Space Bit WQ (Word 7, bit 0)<sup>(1)</sup> is set when the queue is full. This bit is cleared when space is available in the active queue. Do not set or reset this bit. It is informational only.

**TIP**

For a MSG write instruction, when the WQ bit is set, or when only the EN bit is set, your source data is unbuffered. If your application requires buffered (or snapshot) data, wait until the EW bit is set before overwriting your source data.

**Table 12.10 Setting Bits for Buffered Data**

WQ	EN	EW	Description
1	0	0	MSG not queued or buffered
0	1	0	MSG is queued, source data not buffered
0	1	1	MSG and source data is buffered

<sup>(1)</sup> SLC 5/03 and higher processors only.

## MSG Instruction Control Block

### *Limitations for Manipulating the Control Block Bits*

Do not manipulate the MSG instruction control block values except as noted below. For example, do not clear the first word of the control block, do not unlatch the time-out control bit (except in an SLC 5/02 MSG instruction), and so on.

The only MSG instruction control bits that may be manipulated by the ladder program without adversely affecting the operation of the instruction are the CO, EN, and TO bits. The enable bit (EN = bit 15) may be unlatched, but only when the done bit (DN = bit 13) or error bit (ER = bit 12) has been set, indicating the successful or unsuccessful completion of the previous message.

In addition, when a MSG is in progress and the ladder program wishes to terminate it for any reason, this may be done by enabling the time-out bit (TO = bit 8). The next time the processor scans the MSG instruction with the TO bit set, it will error the MSG (ER = 1). The MSG instruction may then be re-enabled with a false-to-true transition on the next program scan.



### Control Block Layouts

The control block layout is shown below for 500CPU or PLC-5 controller as the target device.

**Table 12.11 Read or Write, Local or Remote<sup>(1)</sup> to a 500 CPU or PLC-5<sup>(1)</sup> (Without Logical ASCII/Symbolic Addressing)**

	15	14	13	12	11	10	09	08	07	06	05	04	03	02	01	0
Word 0	EN	ST	DN	ER	CO <sup>(1)</sup>	EW	NR	TO	Error Code							
Word 1	Reserved								Target Node Address (Local)/Remote Station Address (Remote)							
Word 2	Number of Elements															
Word 3	File Number															
Word 4	File Type (S, B, T, C, R, N) (O, I, F, ST, A) <sup>(1)</sup>															
Word 5	Element Number															
Word 6	Not Used															
Word 7 <sup>(1)</sup>	Remote Bridge Address (Remote only)								Reserved (Internal Messaging Bits)							WQ
Word 8 <sup>(1)</sup>	Reserved (Internal Messaging Bits)								Message Timer Preset							
Word 9 <sup>(1)</sup>	Message Timer Scaled Zero															
Word 10 <sup>(1)</sup>	Message Timer Accumulator															
Word 11 <sup>(1)</sup>	Reserved (Internal Messaging Bits)															
Word 12 <sup>(1)</sup>	A0=0	Reserved (Internal Messaging Bits)														
Word 13 <sup>(1)</sup>	Reserved (Internal Messaging Bits)															

<sup>(1)</sup> SLC 5/03 and higher processors only.

The control block layout is shown below for 485CIF as the target device.

**Table 12.12 Read or Write, Local or Remote<sup>(1)</sup> to a 485 CIF**

	15	14	13	12	11	10	09	08	07	06	05	04	03	02	01	0
Word 0	EN	ST	DN	ER	CO <sup>(1)</sup>	EW	NR	TO	Error Code							
Word 1	Not Used								Target Node Address (Local)/Remote Station Address (Remote)							
Word 2	Number of Words															
Word 3	Offset in Words															
Word 4	Not Used															
Word 5	Not Used															
Word 6	Not Used															
Word 7 <sup>(1)</sup>	Remote Bridge Address (Remote only)								Reserved (Internal Messaging Bits)							WQ
Word 8 <sup>(1)</sup>	Reserved (Internal Messaging Bits)								Message Timer Preset							
Word 9 <sup>(1)</sup>	Message Timer Scaled Zero															
Word 10 <sup>(1)</sup>	Message Timer Accumulator															
Word 11 <sup>(1)</sup>	Reserved (Internal Messaging Bits)															
Word 12 <sup>(1)</sup>	Reserved (Internal Messaging Bits)															
Word 13 <sup>(1)</sup>	Reserved (Internal Messaging Bits)															

<sup>(1)</sup> SLC 5/03 and higher processors only.

**Table 12.13 Read or Write, Local or Remote to a PLC-5 (with Logical ASCII/Symbolic Addressing)<sup>(1) (2) (3)</sup>**

	<b>15</b>	<b>14</b>	<b>13</b>	<b>12</b>	<b>11</b>	<b>10</b>	<b>09</b>	<b>08</b>	<b>07</b>	<b>06</b>	<b>05</b>	<b>04</b>	<b>03</b>	<b>02</b>	<b>01</b>	<b>0</b>
Word 0	EN	ST	DN	ER	CO	EW	NR	TO	Error Code							
Word 1	Not Used								Target Node Address (Local)/Remote Station Address (Remote)							
Word 2	Number of Elements															
Word 3	Not Used															
Word 4	File Type (based on local source or destination address)															
Word 5	Not Used															
Word 6	Not Used															
Word 7	Remote Bridge Address (Remote only)								Reserved (Internal Messaging Bits)							WQ
Word 8	Reserved (Internal Messaging Bits)								Message Timer Preset							
Word 9	Message Timer Scaled Zero															
Word 10	Message Timer Accumulator															
Word 11	Reserved (Internal Messaging Bits)															
Word 12	AO=1	Reserved (Internal Messaging Bits)														
Word 13	Reserved (Internal Messaging Bits)								Lower byte internal use.							
Word 14	Logical ASCII Address String Length including NULL Termination Character (bytes)															
Word 15	First Byte of Address String								Second Byte of Address String							
Word 16	Third Byte of Address String								...							
...	...								...							
...	...								...							
Word 55	Eighty-first Byte of ASCII Address String								NULL Byte of Longest ASCII Address String							

<sup>(1)</sup> SLC 5/05 Channel 0.<sup>(2)</sup> SLC 5/04 OS401, Series C, FRN 5 or higher with RSLogix 500 version 4.5 or higher.<sup>(3)</sup> SLC 5/03 OS302, Series C, FRN 5 or higher with RSLogix 500 version 4.5 or higher.

**Table 12.14 SLC 5/05 Channel 1 Read or Write, Local or Remote to an SLC 500 CPU or PLC-5 (without Logical ASCII/Symbolic Addressing)**

	15	14	13	12	11	10	09	08	07	06	05	04	03	02	01	00
Word 0	EN	ST	DN	ER	CO	EW	NR	TO	Error Codes							
Word 1	Reserved								Remote Station Address (Remote only)							
Word 2	Number of Elements															
Word 3	File Number															
Word 4	File Type (based on local source or destination address)															
Word 5	Element Number															
Word 6	Not Used															
Word 7	Remote Bridge Address (Remote Only)								Reserved (Internal Messaging Bits)							WQ
Word 8	Reserved (Internal Messaging Bits)								Message Timer Preset							
Word 9	Message Timer Scaled Zero															
Word 10	Message Timer Accumulator															
Word 11	Reserved (Internal Messaging Bits)															
Word 12	AO=0	Reserved (Internal Messaging Bits)														
Word 13	Reserved (Internal Messaging Bits)															
Word 14	First Byte of IP Address String <sup>(1)</sup>								Second Byte of IP Address String							
Word 15	Third Byte of IP Address String								...							
...	...															
...	...															
Word 34	Forty-First Byte of IP Address String								NULL Byte of Longest IP Address String							
Word 35 <sup>(3)</sup>	Not Used								Ethernet Message Type = 0 <sup>(2)</sup> , 10h <sup>(3)</sup> , or 11h <sup>(3)</sup>							
Word 36 <sup>(3)</sup>	ASA Service								Internal Object Identifier (IOI) Size in Words (1 to 5)							
Words 37 - 41 <sup>(3)</sup>	ASA Internal Object Identifier (IOI)															
Word 42 <sup>(3)</sup>	Not Used								Connection Path Size in Words (1 to 8)							
Words 43 - 50 <sup>(3)</sup>	Connection Path															

<sup>(1)</sup> The IP Address format is up to 42 ASCII characters including a terminating NULL character. The first byte in the array is the left most character in the string as written. For example: If the IP Address is 423.156.78.012, the first byte is the ASCII character "4". If the MSG destination is an INTERCHANGE client on a host computer, the destination is specified as "client" and stored as a NULL terminated string.

<sup>(2)</sup> Not MultiHop MSG.

<sup>(3)</sup> MultiHop MSG.

**Table 12.15 Modbus RTU Master Control Block**

	<b>15</b>	<b>14</b>	<b>13</b>	<b>12</b>	<b>11</b>	<b>10</b>	<b>09</b>	<b>08</b>	<b>07</b>	<b>06</b>	<b>05</b>	<b>04</b>	<b>03</b>	<b>02</b>	<b>01</b>	<b>00</b>
Word 0	EN	ST	DN	ER	CO	EW	NR	TO	Error Codes							
Word 1	Not Used - Always 0								Target Node							
Word 2	Number of Elements															
Word 3	Target Data Address (decrement user input by 1)															
Word 4	Reserved (unused, default to 0)											Start-Bit/Coil/Input at Physical Address				
Word 5	Reserved (unused, default to 0)														Register Size	
Word 6	Not Used - Always 0															
Word 7	Not Used - Always 0								Reserved (Internal Messaging Bits)							WQ
Word 8	Reserved (Internal Messaging Bits)								Message Timer Preset							
Word 9	Message Timer Scaled Zero															
Word 10	Message Timer Accumulator															
Word 11	Reserved (Internal Messaging Bits)															
Word 12	AO=0	Reserved (Internal Messaging Bits)														
Word 13	Reserved (Internal Messaging Bits)															

**Table 12.16 SLC 5/05 Channel 1 Read or Write, Local or Remote to a PLC-5 (with Logical ASCII/Symbolic Addressing)**

	15	14	13	12	11	10	09	08	07	06	05	04	03	02	01	00
Word 0	EN	ST	DN	ER	CO	EW	NR	TO	Error Code							
Word 1	Reserved								Remote Station Address (Remote only)							
Word 2	Number of Elements															
Word 3	Not Used															
Word 4	File Type (Based on Local Source or Destination Address)															
Word 5	Not Used															
Word 6	Not Used															
Word 7	Remote Bridge Address (Remote only)								Reserved (Internal Messaging Bits)							WQ
Word 8	Reserved (Internal Messaging Bits)								Message Timer Preset							
Word 9	Message Timer Scaled Zero															
Word 10	Message Timer Accumulator															
Word 11	Reserved (Internal Messaging Bits)															
Word 12	AO=1	Reserved (Internal Messaging Bits)														
Word 13	Reserved (Internal Messaging Bits)															
Word 14	Logical ASCII Address String Length including NULL Termination Character (bytes)															
Word 15	First Byte of ASCII Address String								Second Byte of ASCII Address String							
Word 16	Third Byte of ASCII Address String								...							
	...								...							
	...								...							
Word 55	Eighty-First Byte of ASCII Address String								NULL Byte of Longest ASCII Address String							
Word 56	First Byte of IP Address String <sup>(1)</sup>								Second Byte of IP Address String							
Word 57	Third Byte of IP Address String								...							
	...								...							
	...								...							
Word 76	Forty-First Byte of IP Address String								NULL Byte of Longest IP Address String							
Word 77	Not Used								Ethernet Message Type = 0 <sup>(2)</sup> , 10h <sup>(3)</sup> , or 11h <sup>(3)</sup>							
Word 78 <sup>(3)</sup>	ASA Service								Internal Object Identifier (IOI) Size in Words (1 to 5)							
Words 79 - 83 <sup>(3)</sup>	ASA Internal Object Identifier (IOI)															
Word 84 <sup>(3)</sup>	Not Used								Connection Path Size in Words (1 to 8)							
Words 85 - 92 <sup>(3)</sup>	Connection Path															

<sup>(1)</sup> The IP Address format is up to 42 ASCII characters including a terminating NULL character. The first byte in the array is the left most character in the string as written. For example: If the IP Address is 423.156.78.012, the first byte is the ASCII character "4". If the MSG destination is an INTERCHANGE client on a host computer, the destination is specified as "client" and stored as a NULL terminated string.

<sup>(2)</sup> Not MultiHop MSG.

<sup>(3)</sup> MultiHop MSG.

## Status Bit Sequencing for SLC 5/03, SLC 5/04, and SLC 5/05 MSG Instruction

The following section describes the status bit sequencing for an SLC 5/03, SLC 5/04, or SLC 5/05 MSG instruction.

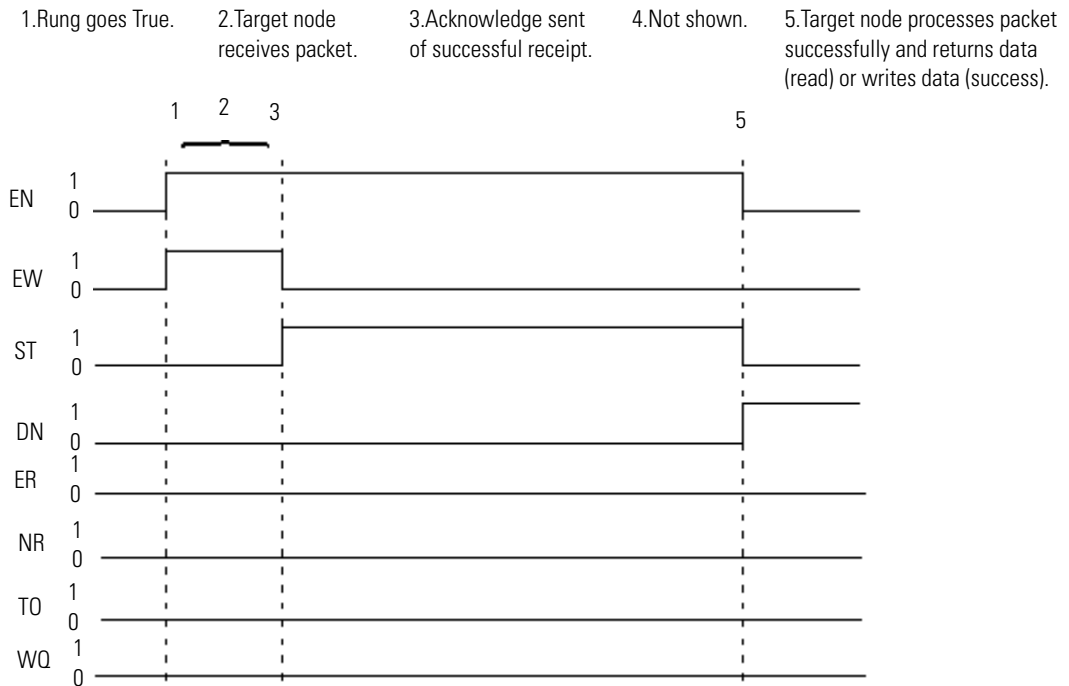

### Rung Goes True

When the MSG rung becomes true and the MSG is scanned, if there is room in any of the four active MSG buffers and no other MSG are in the queue, the MSG is immediately placed in an available buffer, and the EN and EW bits are set. If this was a MSG Write instruction, the source data would be transferred to the MSG buffer at this time. If there is no room in the four MSG buffers or other MSG instructions are already in the queue, and a position is available in the MSG queue, then the MSG enters the queue and only the EN bit is set. The 10-position MSG queue works on a first-in-first-out basis that allows the SLC processor to remember the order the MSG instructions were enabled. Note that the program does not have access to the SLC MSG queue.

If there is no room in any of the four MSG buffers and no room in the 10-position MSG queue, only the WQ bit is set. Note that when the WQ bit is set, the MSG instruction must be re-scanned with true rung conditions at a later time when there is room in either the four MSG buffers or the 10-position MSG queue.

Once the EN bit is set, it remains set until the entire MSG process is complete and either the DN, ER, or TO bit is set. The MSG Timeout period begins timing when the EN bit is set. If the timeout period expires before the MSG instruction completes its function, the ER bit is set and an error code (37H) is placed in the MSG block to inform you of the timeout error.

If you choose to set the CO bit, your MSG instruction will take up permanent residence in one of the four active MSG buffers. The MSG instruction continues to re-transmit its data each time the DN or ER bit is set. If this were a MSG Write instruction, your source data would be updated each MSG cycle.

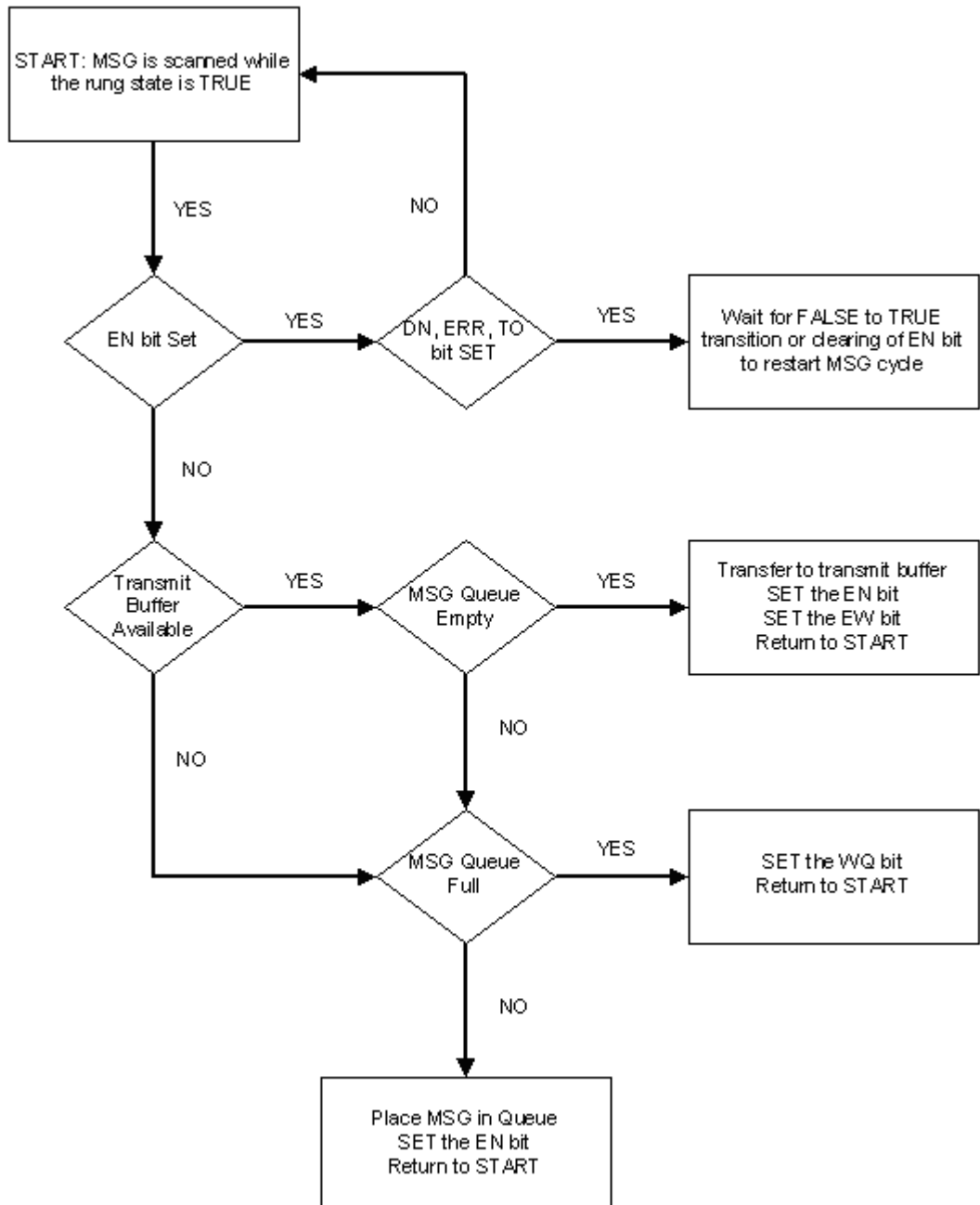



## Next End of Scan

At the next end of scan or SVC, the SLC processor determines if it should examine the MSG queue for “something to do.” The processor bases its decision on the state of bits S:2/15, S:33/7, S:33/5, S:33/6, network communication requests from other nodes, and if previous MSG instructions are already in progress. If the SLC processor determines that it should not access the queue, the MSG instruction remains as it was. (Either the EN and EW bits remain set, or only the EN bit is set, or only the WQ bit is set until the next end of scan or SVC. If only the WQ bit is set, the MSG instruction must be re-scanned later with true rung conditions.)

If the SLC processor determines that it has something to do, it unloads the MSG queue entries into the MSG buffers until all four MSG buffers are full. Each MSG buffer contains a valid network packet. If a packet cannot be successfully built from the MSG queue, the ER bit is set and a code is placed in the MSG block to inform you of an error. When a MSG instruction is loaded into a MSG buffer, the EN and EW bits are set.

The SLC processor then exits the end of scan or SVC portion of the scan. The processor’s background communication function sends the packets to the Target Nodes that you specified in your MSG instruction. Depending on the state of bits S:2/15, S:33/7, S:33/5, and S:33/6 you can have up to eight MSG instructions (four from each channel) active at any given time.

## Successful Receipt of Packet

If the Target Node successfully receives the packet, it sends back an ACK (acknowledge). The ACK causes the processor to clear the EW bit and set the ST bit. The Target Node has not yet examined the packet, to see if it understands your request. Note that the Target Node is not required to respond within any given time frame.

For broadcast write commands, Ethernet and DF1 Radio Modem communication, there is no ACK/NAK mechanism. For the SLC 5/05, the ST bit is set when the Ethernet daughterboard internally indicates it has received the command from the main processor and will send it out. For broadcast write commands and DF1 Radio Modem, the ST bit is set when the command has successfully been transmitted. Skip step 4 for Ethernet and DF1 Radio Modem communications.

**TIP**

If the Target Node faults or power cycles during this time frame of a MSG transaction, you will not receive a reply. As a result, use a MSG Timeout value in your MSG instruction.

Step 4 is not shown in the timing diagram.

## **An ACK is Not Received**

If you do not receive an ACK, step 3 does not occur. Instead, either no response or a NAK (no acknowledge) is received. When this happens, the ST bit remains clear.

These conditions can cause no response.

- The target node is not there.
- The target node does not respond because the packet became too corrupted in transmission to be properly received.
- The response was corrupted in transmission back.

These conditions can cause a NAK.

- Target node is too busy.
- Target node received a corrupt packet.

## **Target Node Sends a Reply Packet**

Following the successful receipt of the packet, the Target Node sends a reply packet. The reply packet will contain one of the following responses.

- The write request was successfully performed.
- The read request was successfully performed and here is the data.
- The request was not performed because of an error.

At the next end of scan or SVC, following the Target Node's reply, the SLC processor examines the packet from the target device. If the reply contains successfully performed the write request, the DN bit is set and the ST bit is cleared. The MSG instruction function is complete. If the MSG rung is false, the EN bit is cleared the next time the MSG instruction is scanned.

If the reply contains successfully performed the read request, and here is the data, the data is written to the data table, the DN bit is set and the ST bit is cleared. The MSG instruction function is complete. If the MSG rung is false, the EN bit is cleared the next time the MSG instruction is scanned.

If the reply contains the request was not performed because of an error, the ER bit is set and the ST bit is cleared. The MSG instruction function is complete. If the MSG rung is false, the EN bit is cleared the next time the MSG instruction is scanned.

For SLC 5/03 (OS301 and higher), SLC 5/04, and SLC 5/05 processors, there are four MSG buffers per channel. Each channel has its own 10-position MSG queue. The SLC processor unloads the two MSG queues into the MSG buffers evenly at end of scan or SVC. This gives both channels equal access to communications. If you program a SVC instruction that is configured to service only one channel, then only that channel will have its MSG queue unloaded into the MSG buffers (until the next end of scan or SVC when both channels will again be unloaded evenly).

## MSG Instruction Error Codes

When the processor detects an error during the transfer of message data, the processor sets the ER bit and enters an error code that you can monitor from your programming software.

**Table 12.17 MSG Instruction Error Codes**

Error Code	Description of Error Condition
02H	Target node is busy. The MSG instruction will automatically reload. If other messages are waiting, the message is placed at the bottom of the stack.
03H	Target node cannot respond because message is too large.
04H	Target node cannot respond because it does not understand the command parameters OR the control block may have been inadvertently modified.
05H	Local processor is offline (possible duplicate node situation).
06H	Target node cannot respond because requested function is not available.
07H	Target node does not respond.
08H	Target node cannot respond.
09H	Local modem connection has been lost.
0AH	Buffer unavailable to receive SRD reply.
0BH	Target node does not accept this type of MSG instruction.
0CH	Received a master link reset (one possible source is from the DF1 master).
10H	Target node cannot respond because of incorrect command parameters or unsupported command, or the data file specified does not exist.
11H	Local file has constant file protection.
12H	Local channel configuration protocol error exists.
13H	Local MSG configuration error in the Remote MSG parameters.
14H	Local communication driver is incompatible with the MSG instruction.
15H	Local channel configuration parameter error exists.
16H	Target or Local Bridge address is higher than the maximum node address.
17H	Local service is not supported.
18H	Broadcast (Node Address 255) is not supported.

**Table 12.17 MSG Instruction Error Codes (Continued)**

<b>Error Code</b>	<b>Description of Error Condition</b>
19H	Improperly formatted Logical ASCII Address string. String not properly terminated with a NULL character or the string length does not match the value in the length parameter.
20H	Target Node responded with: Host has a problem and will not communicate.
30H	Target Node responded with: Remote station host is not there, disconnected, or shutdown.
37H	Message timed out in local processor.
38H	Message disabled pending link response.
40H	Target Node responded with: Host could not complete function due to hardware fault.
45h	Parameters of a reply to a MSG command do not match what was expected.
50H	Target node is out of memory.
60H	Target node cannot respond because file is protected.
70H	Target Node responded with: Processor is in Program Mode.
80H	Target Node responded with: Compatibility mode file missing or communication zone problem.
81H	Modbus Error 1: Illegal Function. The function code sent by the Master is not supported by the slave or has an incorrect parameter.
82H	Modbus Error 2: Illegal Data Address. The data address referenced in the Master command does not exist in the slave, or access to that address is not allowed.
83H	Modbus Error 3: Illegal Data Value. The data value being written is not allowed, either because it is out of range, or because it is being written to a read-only address.
84H	Modbus Error 4: Slave Device Failure. An irrecoverable error occurred while the slave was attempting to perform the requested action.
85H	Modbus Error 5: Acknowledge. The slave has accepted the request, but a long duration of time will be required to process the request.
86H	Modbus Error 6: Slave Device Busy. The slave is currently processing a long-duration command.
87H	Modbus Error 7: Negative Acknowledge. The slave cannot perform the program function received in the command.
88H	Modbus Error 8: Memory Parity Error. The slave attempted to read extended memory, but detected a parity error in the memory.
89H	Modbus Error: Non-standard reply. An error code greater than 8 was returned by the slave.
90H	Target Node responded with: Remote station cannot buffer command.
B0H	Target Node responded with: Remote station problem due to download.
C0H	Target Node responded with: Cannot execute command due to active IPBs.
D0H	No IP address configured for the network, -or- Bad command - unsolicited message error, -or- Bad address - unsolicited message error, -or- No privilege - unsolicited message error, -or- Multihop messaging cannot route request.
D1H	Maximum connections used - no connections available
D2H	Invalid internet address or host name
D3H	No such host
D4H	Cannot communicate with the name server
D5H	Connection not completed before user-specified timeout

**Table 12.17 MSG Instruction Error Codes (Continued)**

<b>Error Code</b>	<b>Description of Error Condition</b>
D6H	Connection timed out by the network
D7H	Connection refused by destination host
D8H	Connection was broken
D9H	Reply not received before user-specified timeout
DAH	No network buffer space available
DBH	Multi-hop messaging CIP message format error
DFH	MSG has no IP address configured for network
E1H	Target Node responded with: Illegal Address Format, a field has an illegal value.
E2H	Target Node responded with: Illegal Address format, not enough fields specified.
E3H	Target Node responded with: Illegal Address format, too many fields specified.
E4H	Target Node responded with: Illegal Address, symbol not found.
E5H	Target Node responded with: Illegal Address Format, symbol is 0 or greater than the maximum number of characters support by this device.
E6H	Target Node responded with: Illegal Address, address does not exist, or does not point to something usable by this command.
E7H	Target node cannot respond because length requested is too large.
E8H	Target Node responded with: Cannot complete request, situation changed (file size, for example) during multi-packet operation.
E9H	Target Node responded with: Data or file is too large. Memory unavailable.
EAH	Target Node responded with: Request is too large; transaction size plus word address is too large.
EBH	Target node cannot respond because target node denies access.
ECH	Target node cannot respond because requested function is currently unavailable.
EDH	Target Node responded with: Resource is already available; condition already exists.
EEH	Target Node responded with: Command cannot be executed.
EFH	Target Node responded with: Overflow; histogram overflow.
F0H	Target Node responded with: No access
F1H	Local processor detects illegal target file type.
F2H	Target Node responded with: Invalid parameter; invalid data in search or command block.
F3H	Target Node responded with: Address reference exists to deleted area.
F4H	Target Node responded with: Command execution failure for unknown reason; PLC-3 histogram overflow.
F5H	Target Node responded with: Data conversion error.
F6H	Target Node responded with: The scanner is not able to communicate with a 1771 rack adapter.
F7H	Target Node responded with: The adapter is not able to communicate with a module.
F8H	Target Node responded with: The 1771 module response was not valid - size, checksum, etc.
F9H	Target Node responded with: Duplicated Label.
FAH	Target node cannot respond because another node is file owner (has sole file access).
FBH	Target node cannot respond because another node is program owner (has sole access to all files).

**Table 12.17 MSG Instruction Error Codes (Continued)**

Error Code	Description of Error Condition
FCH	Target Node responded with: Disk file is write protected or otherwise inaccessible (off-line only).
FDH	Target Node responded with: Disk file is being used by another application; update not performed (off-line only).
FFH	Local communication channel is shut down.

**TIP**

The MSG error code reflects the STS field of the reply to your MSG instruction.

Codes E0 - EF represent EXT STS codes 0 - F.

Codes F0 - FC represent EXT STS codes 10 - 1C.

## Explicit Message Instruction Overview

The CEM, DEM, and EEM explicit message instructions allow generic Common Industrial Protocol (CIP) commands to be initiated to devices, such as drives, communicating on ControlNet, DeviceNet, and EtherNet/IP networks. Each instruction requires RSLogix 500 version 7.10 or higher software for programming.

The CEM instruction utilizes the explicit message capability built into the 1747-SCNR ControlNet scanner module, while the DEM instruction utilizes the explicit message capability built into the 1747-SDN DeviceNet scanner module. While not adding any additional capability over what already exists in the scanner modules, the CEM and DEM instructions greatly simplify the programming, configuration, monitoring, and troubleshooting of explicit messages on ControlNet and DeviceNet. Unlike I/O configured in the scanner module's scan list, which is updated on a continual basis, explicit messages allow data to be sent and received on an as-needed basis, minimizing network traffic. For instance, you may only want to write configuration parameters to a drive once at machine start-up time. The CEM and DEM instructions can be used with any SLC 5/03, 5/04, or 5/05 processor that is at OS firmware level Series C, FRN 10 or higher.

The EEM instruction explicit message capability is implemented through the channel one Ethernet port of the SLC 5/05 processor. It shares the same queuing and buffering scheme, as well as Ethernet connection resources, that are used by the MSG instruction. Like the standard MSG instruction, data can be sent and received on an as-needed basis. Ethernet explicit messages are useful for communicating with third party EtherNet/IP devices that don't understand standard MSG commands, as well as providing access to data in Allen-Bradley EtherNet/IP devices that isn't accessible via standard MSG instruction commands. The EEM instruction can be used with any SLC 5/05 processor at OS firmware level Series C, FRN 10 or higher.

All three instructions use an integer control block for storing the instruction parameters and a configuration setup screen, similar to the MSG instruction. The CIP commands consist of a Service Code; the object Class, Instance, and Attribute; and Send and Receive Data (if required for the selected Service Code). The setup screen provides a list of standard CIP Services to select from, including:

- Read Assembly.
- Write Assembly.
- Read Parameter.
- Write Parameter.
- Generic Get Attribute Single.
- Generic Set Attribute Single.

In addition, a Custom setting lets you enter any Service Code. For the CEM and EEM instructions, send data and receive data are stored in separate data table files. For the DEM instruction, send data and receive data are both stored within the instruction control block.

## ControlNet Explicit Message (CEM)



Fixed	SLC 5/01	SLC 5/02	SLC 5/03	SLC 5/04	SLC 5/05
			•	•	•

Output Instruction

This is an output instruction that lets you initiate unconnected CIP Generic messages via a 1747-SCNR ControlNet scanner module installed in the local chassis. These messages can be initiated to any nodes on the same ControlNet network as the 1747-SCNR, regardless of whether the destination node is in the scanner’s scan list or not, and regardless of whether the scanner is in Run mode or Idle mode. Each scanner module can process only one CEM instruction at a time. The instruction is similar in operation to a standard MSG instruction.

### CEM Instruction Parameters

Enter the following parameters when programming this instruction.

- **Control Block** is an integer file address that you select. It is a block of words, containing the status bits and other data associated with the CEM instruction.
- **Control Block Length** is a display-only field that indicates how many integer file words are being used by the control block. For the CEM instruction, the length is always 67 words.

## CEM Instruction Setup Screen Parameters

The following sections provide parameters for the CEM instruction setup screens.

### *Parameters for This Controller on the General Tab*

- 1747-SCNR Slot

This drop-down field lists all of the local slots that contain ControlNet scanner (1747-SCNR) modules within the IO Configuration. Select the slot number of the particular scanner module that this explicit message will be initiated through.

- Size in Words (Receive Data)

This field defines the size of the integer data file that will be used to store the data that is returned by this explicit message command. For best performance, define this file size to only be as large as is required. If no receive data is expected, you may leave this field at 0 and no receive data file will be defined. If unsure of how much data will be returned, you may select up to the maximum size of 250 words, and then reduce the size later based on experience.

- Size in Words (Send Data)

This field defines the size of the integer data file that will be used to store the data that is sent along with this explicit message command. For best performance, define this file size to only be as large as is required. If no send data is required, you may leave this field at 0 and no send data file will be defined. If unsure of how much data will be sent, you may select up to the maximum size of 248 words when defining the instruction, and then reduce the size later based on experience.

- Data Table Address (Send Data)

If Size in Words (Send Data) is non-zero, then this field requires a starting integer (N) file address for storing the Send Data.

- Data Table Address (Receive Data)

If Size in Words (Receive Data) is non-zero, then this field requires a starting integer (N) file address for storing the Receive Data.



### *Parameters for Target Device on the General Tab*

- Message Timeout(x1 ms)

The amount of time in milliseconds that the scanner will wait for a reply to the explicit message command. Range is 2 to 32767.

- ControlNet Addr (dec)

The target ControlNet node address. Valid range is 1 to 99. If you enter in the local scanner's ControlNet node address, the command is executed by the local scanner.

- Service

This dropdown allows you to select services based on name rather than Service Code. The Custom service allows you to enter in any Service Code in the hexadecimal range of 1 to 7F. The services listed in the dropdown selection are:

- Read Assembly.
- Write Assembly.
- Write Output Point.
- Read Output Point.
- Read Input Point.
- Read Parameter.
- Write Parameter.
- Read Analog Input.
- Write Analog Output.
- Generic Get Attribute Single.
- Generic Set Attribute Single.
- Generic Get Member.
- Generic Set Member.
- Reset Identity Object.
- Custom.

- Service Code (hex)

This field is read-only unless the Custom Service is selected. Possible Service Codes are 1 to 7F (hex). See Volume 1 of the CIP Common Specification, Appendix A, for the list of valid explicit messaging Service Codes.

- Class (hex)/(dec)

Possible Classes are 0 to FF (hex). See Volume 1 of the CIP Common Specification for the list of defined Classes. You may either enter in a hexadecimal Class value in the (hex) field or a decimal Class value in the (dec) field.

- Instance (hex)/(dec)

Possible Instances are 0 to FFFF (hex). See Volume 1 of the CIP Common Specification for the list of valid Instances for each Class. You may either enter in a hexadecimal Instance value in the (hex) field or a decimal Instance value in the (dec) field.

- Attribute (hex)/(dec)

Possible Attributes are 0 to FFFF (hex). See Volume 1 of the CIP Common Specification for the list of valid Attributes for each Class. You may either enter in a hexadecimal Attribute value in the (hex) field or a decimal Attribute value in the (dec) field.

- Member (hex)/(dec)

Possible Members are 0 to FFFF (hex). See Volume 1 of the CIP Common Specification for the list of valid Members for each Class. You may either enter in a hexadecimal Member value in the (hex) field or a decimal Member value in the (dec) field.

### *Definitions for Message Status Bits on the General Tab*

The table below lists the various status bits associated with the CEM instruction as displayed in the CEM instruction setup screen.

**Table 12.18 CEM Instruction Setup Screen Status Bits**

<b>Bit Definition</b>	<b>Bit Mnemonic</b>	<b>Bit Address</b>
Timeout	TO	08
Error	ER	12
Done	DN	13
Enabled	EN	15
Waiting for slot	WS	10

- Timeout bit TO (word 0, bit 8) is set when the scanner module times out the message either due to no response from the target device or due to no reply being returned within the configured timeout period. The ER bit will be set at the same time the TO bit is set. This bit is reset the next time the message rung goes from false to true. Do not set or reset this bit. It is informational only.

- Error bit ER (word 0, bit 12) is set when the message has failed to complete successfully. This bit is reset the next time the message rung goes from false to true. Do not set or reset this bit. It is informational only.
- Done bit DN (word 0, bit 13) is set when the message has completed successfully. This bit is reset the next time the message rung goes from false to true. Do not set or reset this bit. It is informational only.
- Enabled bit EN (word 0, bit 15) is set after the message rung goes from false to true AND the scanner module accepts this message because it is not currently processing any other explicit messages. (The scanner module can process only one CEM instruction at a time.) If the message rung goes false before the scanner module accepts this message, then the enable bit will remain off and the message will not be executed. This bit is reset when the message has completed with either the Done bit set or the Error bit set and the message rung goes false. If the message rung conditions remain true, you may retrigger the message instruction by resetting this bit after either the ER or DN bit has been set, indicating that the previous execution has completed.
- Waiting for Slot bit WS (word 0, bit 10) is set when the message rung goes from false to true, but the scanner module is still processing another CEM instruction. In order to ensure that this message gets processed, you must leave the message rung conditions true until the WS bit is reset and the EN bit is set, indicating that the scanner module has accepted this message for processing. Do not set or reset this bit. It is informational only.

### *Scanner Status, Error, and Error Description on the General Tab*

The Scanner Code displays the explicit message status returned by the scanner module. A scanner code of 0 means no errors. Table 12.19 lists other valid scanner codes.

**Table 12.19 CEM Instruction Scanner Codes**

<b>Scanner Code</b>	<b>Description of Scanner Status</b>
201H	Invalid command data size
202H	Internal fault detected
204H	Invalid service code
205H	Invalid IOI size
206H	Invalid CIP request block contents
207H	CIP message request timeout
208H	CIP timeout value too small

A scanner code of 0x207 results in an error code of 1. All other scanner codes listed result in an Error Code of 2. Table 12.20 list all valid CEM instruction Error Codes.

**Table 12.20 Valid CEM Instruction Error Codes**

Error Code	Description of Error Condition
0	No error.
1	Timeout error. ControlNet explicit message timed out by scanner.
2	Scanner error. See Scanner Status.
3	Configuration error. Send file length > 248 or invalid IOI size.
5	Processor error. Invalid response.
6	Processor error. Unsolicited response received.
7	Configuration error. Size of response data > receive data size.

For error code 4, the error description displays the CIP response error code and description as documented in the CIP Common Specification, Appendix B.

Any time the Error Code is non-zero, the CEM error (ER) bit is set.

### *Send Data Tab*

The Send Data Tab provides a convenient way of viewing and entering in data to be sent along with the explicit message command. The data is shown in byte format with a selectable radix of either Decimal or Hex/BCD. The display only shows the number of words that are defined in the Size in Words (Send Data) field, starting with the low byte of the first word as defined in the Data Table Address (Send Data) field. If the Size in Words is zero, then no data is displayed. You can also change the data being viewed, but only when offline or during an online edit. Click on the data and enter in a byte value based on the current radix (0 to 255 for Decimal and 0 to FF for Hex/BCD). The changed data gets copied to the Send Data data table file when the rung is accepted. To update the Send Data display with the current values stored in the Send Data data table file, click on the Refresh button.

### *Receive Data Tab*

The Receive Data Tab provides a convenient way of viewing the data that is returned by the target device in response to the explicit message command sent. The data is shown in byte format with a selectable radix of either Decimal or Hex/BCD. The display only shows the number of words that are defined in the Size in Words (Receive Data) field, starting with the low byte of the first word as defined in the Data Table Address (Receive Data) field. If the Size in Words is zero, then no data is displayed. To update the Receive Data display with the current values stored in the Receive Data data table file, click on the Refresh button.

*Control Block Layout*

The control block layout is shown below.

**Table 12.21 SLC 5/0x ControlNet Explicit Message (CEM) Control Block Structure**

	15	14	13	12	11	10	09	08	07	06	05	04	03	02	01	0
Word 0	EN		DN	ER		WS		TO	Reserved by 1747-SCNR							
Word 1	Target MAC ID															
Word 2	Message Timeout Preset (x1 ms)															
Word 3	Complex IOI Size															
Word 4	Reserved								Service Code							
Word 5	Reserved								Class							
Word 6	Instance															
Word 7	Attribute															
Word 8	Member															
Word 9	Size of Command Data (Words)															
Word 10	Request Status - Scanner Status (Scanner Code)															
Word 11	Response Status															
Word 12	Extended Status Size (Words)															
Word 13	Size of response and status (Words)															
Word 14	Complex IOI Buffer (Allows you to manually set IOI)															
-----																
Word 63																
Word 64	Error Code								Transaction ID							
Word 65	Extended Status Debug Word 1															
Word 66	Extended Status Debug Word 2															

## DeviceNet Explicit Message (DEM)



This is an output instruction that lets you initiate unconnected CIP Generic messages via a 1747-SDN DeviceNet scanner module installed in the local chassis. These messages can be initiated to any node on the same DeviceNet network as the 1747-SDN, as long as the node is in the scanner’s scan list. The scanner can be in either Idle mode or Run mode. Each scanner module can only process one DEM instruction at a time. The instruction is similar in operation to a standard MSG instruction.

Fixed	SLC 5/01	SLC 5/02	SLC 5/03	SLC 5/04	SLC 5/05
			•	•	•

### DEM Instruction Parameters

Enter the following parameters when programming this instruction:

- **Control Block** is an integer file address that you select. It is a block of words, containing the status bits and other data associated with the DEM instruction. It also contains the Send and Receive data.
- **Control Block Length** is a display-only field that indicates how many integer file words are being used by the control block. For the DEM instruction, the length is always 70 words.

### DEM Instruction Setup Screen Parameters

The following sections provide parameters for the DEM instruction setup screens.

#### *Parameters for This Controller on the General Tab*

- 1747-SDN Slot

This drop-down field lists all of the local slots that contain DeviceNet scanner (1747-SDN) modules within the IO Configuration. Select the slot number of the particular scanner module that this explicit message will be initiated through.

- Size in Send Data (Bytes)

This field defines how many bytes of data are sent along with this explicit message command. If unsure of how much data will be sent, you may select up to the maximum size of 52 bytes when defining the instruction, and then reduce the size later based on experience.

### *Parameters for Target Device on the General Tab*

- Message Timeout(x1 sec)

The amount of time in seconds that the processor will wait for a reply from the scanner to the explicit message command. Range is 0, 2 to 255. Like the Message Timeout in a standard MSG instruction, a value of 0 disables the Message Timeout and a value of 1 second gets bumped to 2 seconds upon instruction execution. If the built-in Message Timeout is disabled, user programmed timeout logic must be included to avoid a message lockup in the case where a reply is lost.

- DeviceNet Addr (dec)

The target DeviceNet node address. Valid range is 0 to 63. If you enter in the local scanner's DeviceNet node address, the command is executed by the local scanner.

- Service

This pulldown lets you select services based on name rather than Service Code. The Custom service allows you to enter in any Service Code in the hexadecimal range of 1 to 7F. The services listed in the pulldown selection are:

- Read Assembly.
- Write Assembly.
- Write Output Point.
- Read Output Point.
- Read Input Point.
- Read Parameter.
- Write Parameter.
- Read Analog Input.
- Write Analog Output.
- Generic Get Attribute Single.
- Generic Set Attribute Single.
- Reset Identity Object.
- Custom.

- Service Code (hex)

This field is read-only unless the Custom Service is selected. Possible Service Codes are 1 to 7F (hex). See Volume 1 of the CIP Common Specification, Appendix A, for the list of valid explicit messaging Service Codes.

- Class (hex)/(dec)

Possible Classes are 0 to FF (hex). See Volume 1 of the CIP Common Specification for the list of defined Classes. You may either enter in a hexadecimal Class value in the (hex) field or a decimal Class value in the (dec) field.

- Instance (hex)/(dec)

Possible Instances are 0 to FFFF (hex). See Volume 1 of the CIP Common Specification for the list of valid Instances for each Class. You may either enter in a hexadecimal Instance value in the (hex) field or a decimal Instance value in the (dec) field.

- Attribute (hex)/(dec)

Possible Attributes are 0 to FF (hex). See Volume 1 of the CIP Common Specification for the list of valid Attributes for each Class. You may either enter in a hexadecimal Attribute value in the (hex) field or a decimal Attribute value in the (dec) field. Note that if the value of the Attribute is set to 0, the DeviceNet scanner does not transmit an Attribute byte. Some Service Codes require that a zero-value Attribute byte be transmitted. For these Service Codes, the first byte of the Send Data must be set to zero and the Size of Send Data (Bytes) must include this additional byte.

### *Definitions for Message Status Bits on the General Tab*

The table below lists the various status bits associated with the DEM instruction as displayed in the DEM instruction setup screen.

**Table 12.22 DEM Instruction Setup Screen Status Bits**

Bit Definition	Bit Mnemonic	Bit Address
Abort	AB	08
Error	ER	12
Done	DN	13
Enabled	EN	15
Waiting for slot	WS	10

- Abort bit AB (word 0, bit 8) lets you abort an executing DEM instruction by setting this bit. The ER bit will be set as soon as the AB bit is set. This bit is reset the next time the message rung goes from false to true.
- Error bit ER (word 0, bit 12) is set when the message has failed to complete successfully. This bit is reset the next time the message rung goes from false to true. Do not set or reset this bit. It is informational only.



- Done bit DN (word 0, bit 13) is set when the message has completed successfully. This bit is reset the next time the message rung goes from false to true. Do not set or reset this bit. It is informational only.
- Enabled bit EN (word 0, bit 15) is set after the message rung goes from false to true AND the scanner module accepts this message because it is not currently processing any other explicit messages. (The scanner module can only process one DEM instruction at a time.) If the message rung goes false before the scanner module accepts this message, then the enable bit will remain off and the message will not be executed. This bit is reset when the message has completed with either the Done bit set or the Error bit set and the message rung goes false. If the message rung conditions remain true, you may retrigger the message instruction by resetting this bit after either the ER or DN bit has been set, indicating that the previous execution has completed.
- Waiting for Slot bit WS (word 0, bit 10) is set when the message rung goes from false to true, but the scanner module is still processing another DEM instruction. To ensure that this message gets processed, you must leave the message rung conditions true until the WS bit is reset and the EN bit is set, indicating that the scanner module has accepted this message for processing. Do not set or reset this bit. It is informational only.

### *Scanner Status, Error, and Error Description on the General Tab*

The error code displays the explicit message status returned by the scanner module. An error code of 01h means Transaction completed successfully.

**Table 12.23 DEM Instruction Scanner Codes**

<b>Scanner Code</b>	<b>Description of Scanner Status</b>
2H	Transaction in progress.
3H	Slave not in scan list.
4H	Slave offline.
5H	DeviceNet port disabled/offline.
6H	Transaction TXID unknown.
7H	Slave not responding to explicit request.
8H	Invalid command code.
9H	Scanner out of buffers.
10H	Another transaction in progress.
11H	Could not connect to slave device.
12H	Response data too large for block.
13H	Invalid port.
14H	Invalid size specified.
15H	Connection busy.

All error codes listed above result in an error code of 2.

**Table 12.24 Complete List of Valid DEM Error Codes**

<b>Error Code</b>	<b>Description of Error Condition</b>
0	No error.
1	Timeout error. DeviceNet explicit message timed out by processor.
2	Scanner error. See Scanner Status.
3	User error. DeviceNet explicit message aborted by user.

For error code 4, the error description displays the CIP response error code and description as documented in the CIP Common Specification, Appendix B.

Any time the error code is non-zero, the DEM error (ER) bit is set.

### *Send Data Tab*

The Send Data Tab provides a convenient way of viewing and entering in data to be sent along with the explicit message command. The data is shown in byte format with a selectable radix of either Decimal or Hex/BCD. The display only shows the number of words that are defined in the Size of Send Data (Bytes) field, starting with the low byte of the first word. If the Size of Send Data is zero, then no data is displayed. You can also change the data being viewed, but only when offline or during an online edit. Click on the data and enter in a byte value based on the current radix (0 to 255 for Decimal and 0 to FF for Hex/BCD). The changed data gets copied to the DEM control block when the rung is accepted. To update the Send Data display with the current values stored in the DEM control block, click on the Refresh button.

### *Receive Data Tab*

The Receive Data Tab provides a convenient way of viewing the data that is returned by the target device in response to the explicit message command sent. The data is shown in byte format with a selectable radix of either Decimal or Hex/BCD. The display shows 58 bytes of receive data, starting with the low byte of the first word. To update the Receive Data display with the current values stored in the DEM control block, click on the Refresh button.

*Control Block Layout*

The control block layout is shown below.

**Table 12.25 SLC 5/0x DeviceNet Explicit Message (DEM) Control Block Structure**

	15	14	13	12	11	10	09	08	07	06	05	04	03	02	01	0
Word 0	EN		DN	ER		WS		AB	Error Code							
Word 1								IMR	Message Timeout Preset							
Word 2	Message Timeout Accumulator															
Word 3	Message Timer Scaled Zero															
Word 4	Unused															
Word 5	Unused															
Word 6	Transaction ID								Scanner Command							
Word 7	Scanner Port (always 0x00)								Size of Send Data (in bytes)							
Word 8	Service Code								Target MAC ID							
Word 9	Reserved (not transmitted)								Class							
Word 10	Instance															
Word 11	Reserved (not transmitted)								Attribute (optional)							
Word 12	Transaction Send Data (next 26 words)															
-----																
Word 37																
Word 38	Transaction ID								Scanner Status							
Word 39	Scanner Port (always 0x00)								Size of Reply Data (in bytes)							
Word 40	Reply Service Code								Target MAC ID							
Word 41	Transaction Reply/Receive Data (next 29 words)															
-----																
Word 69																

## EtherNet/IP Explicit Message (EEM)



This output instruction lets you initiate connected CIP Generic messages via channel 1 on a SLC 5/05 processor. These messages can be initiated to EtherNet/IP nodes on the same Ethernet network as the SLC 5/05 or can be bridged through a ControlLogix gateway to nodes on remote ControlNet or Ethernet networks. The instruction is similar in operation to a standard MSG instruction.

Fixed	SLC 5/01	SLC 5/02	SLC 5/03	SLC 5/04	SLC 5/05
					•

### EEM Instruction Parameters

Enter the following parameters when programming this instruction:

- **Control Block** is an integer file address that you select. It is a block of words, containing the status bits and other data associated with the EEM instruction.
- **Control Block Length** is a display-only field that indicates how many integer file words are being used by the control block. For the EEM instruction, the length is always 58 words.

### EEM Instruction Setup Screen Parameters

*Parameters for This Controller on the General Tab*

- Channel

Always 1.

- Size in Words (Receive Data)

This field defines the size of the integer data file that will be used to store the data that is returned by this explicit message command. For best performance, define this file size to only be as large as is required. If no receive data is expected, you may leave this field at 0 and no receive data file will be defined. If unsure of how much data will be returned, you may select up to the maximum size of 124 words, and then reduce the size later based on experience.

- Size in Words (Send Data)

This field defines the size of the integer data file that will be used to store the data that is sent along with this explicit message command. For best performance, define this file size to only be as large as is required. If no send data is required, you may leave this field at 0 and no send data file will be defined. If unsure of how much data will be sent, you may select up to the maximum size of 124 words when defining the instruction, and then reduce the size later based on experience.

- Data Table Address (Send Data)

If Size in Words (Send Data) is non-zero, then this field requires a starting integer (N) file address for storing the Send Data.

- Data Table Address (Receive Data)

If Size in Words (Receive Data) is non-zero, then this field requires a starting integer (N) file address for storing the Receive Data.

### *Parameters for Target Device on the General Tab*

- Message Timeout (x1 sec)

Message Timeout for the EEM cannot be modified in the Setup Screen. It is assigned by the processor and is determined by adding the Channel 1 Msg Connection Timeout value to the Channel 1 Msg Reply Timeout value, then adding five seconds. This value can be modified by changing one or both of the timeout values in the Channel 1 Channel Configuration Screen. The modified message timeout applies to all EEM and Ethernet MSG instructions.

- MultiHop

Always Yes.

- Service

This pulldown lets you select services based on name rather than Service Code. The Custom service lets you enter in any Service Code in the hexadecimal range of 1 to 7F. The services listed in the pulldown selection are:

- Read Assembly.
- Write Assembly.
- Write Output Point.
- Read Output Point.
- Read Input Point.
- Read Parameter.
- Write Parameter.
- Read Analog Input.
- Write Analog Output.
- Generic Get Attribute Single.
- Generic Set Attribute Single.
- Reset Identity Object.
- Custom.

- Service Code (hex)

This field is read-only unless the Custom Service is selected. Possible Service Codes are 1 to 7F (hex). See Volume 1 of the CIP Common Specification, Appendix A, for the list of valid explicit messaging Service Codes.

- Class (hex)/(dec)

Possible Classes are 0 to FFFF (hex). See Volume 1 of the CIP Common Specification for the list of defined Classes. You may either enter in a hexadecimal Class value in the (hex) field or a decimal Class value in the (dec) field.

- Instance (hex)/(dec)

Possible Instances are 0 to FFFF (hex). See Volume 1 of the CIP Common Specification for the list of valid Instances for each Class. You may either enter in a hexadecimal Instance value in the (hex) field or a decimal Instance value in the (dec) field.

- Attribute (hex)/(dec)

Possible Attributes are 0 to FF (hex). See Volume 1 of the CIP Common Specification for the list of valid Attributes for each Class. You may either enter in a hexadecimal Attribute value in the (hex) field or a decimal Attribute value in the (dec) field.

*Definitions for Message Status Bits on the General Tab*

The table below lists the various status bits associated with the EEM instruction as displayed in the EEM instruction setup screen.

**Table 12.26 EEM Instruction Setup Screen Status Bits**

<b>Bit Definition</b>	<b>Bit Mnemonic</b>	<b>Bit Address</b>
Ignore if timed out	TO	0/8
Awaiting execution	EW	0/10
Continuous run	CO	0/11
Error	ER	0/12
Done	DN	0/13
Transmitting	ST	0/14
Enabled	EN	0/15
Waiting for queue space	WQ	7/0

- Ignore if timed out bit TO (word 0, bit 8) is set when the EEM instruction times out due to no reply being returned within the configured timeout period. You may also set this bit in order to abort the EEM instruction before it has completed. The ER bit will be set at the same time the TO bit is set. This bit is reset the next time the message rung goes from false to true.
- Awaiting execution bit EW (word 0, bit 10) is set after the enable bit is set and the message is physically placed in one of the four available channel 1 transmit buffers. The EW bit is reset when either the ST or ER bit is set. Do not set or reset this bit. It is informational only.
- Continuous run bit CO (word 0, bit 11) can be set in order to continually resend the EEM command. Once the CO bit is set and the EEM instruction is triggered, the EEM command will occupy one of the four channel 1 transmit buffers. Therefore, a maximum of four EEM and channel 1 MSG instructions may have their CO bits set at the same time.
- Error bit ER (word 0, bit 12) is set when the message has failed to complete successfully. This bit is reset the next time the message rung goes from false to true. Do not set or reset this bit. It is informational only.
- Done bit DN (word 0, bit 13) is set when the message has completed successfully. This bit is reset the next time the message rung goes from false to true. Do not set or reset this bit. It is informational only.
- Transmitting bit ST (word 0, bit 14) is set when the Ethernet daughtercard has validated and accepted the EEM command for a transmission attempt. The command may not have been transmitted yet. Do not set or reset this bit. It is informational only.

- Enabled bit EN (word 0, bit 15) is set after the message rung goes from false to true and there is space available in either the channel 1 message buffers or message queue. It remains set until message transmission is completed and the rung goes false. If the message rung conditions remain true, you may retrigger the message instruction by resetting this bit after either the ER or DN bit has been set, indicating that the previous execution has completed.
- Waiting for Queue Space bit WQ (word 7, bit 0) is set when the message rung goes from false to true, but the channel 1 message buffers and message queue are full. In order to assure that this EEM command gets processed, you must leave the message rung conditions true until the WQ bit is reset and the EN bit is set, indicating that the EEM command has been placed into the message queue. Do not set or reset this bit. It is informational only.

### *Error and Error Description on the General Tab*

The error codes for the EEM instruction are a superset of the MSG instruction error codes.

Refer to p. 12-41 for a listing of the MSG instruction error codes.

Table 12.27 lists other valid error codes.

**Table 12.27 EEM Instruction Error Codes**

<b>Error Code</b>	<b>Description of Error Condition</b>
51	CIP response error code.
52	Configuration error. Receive/send data size exceeds 124 words.
53	Configuration error. Response data > receive data file size.
54	Response error. Unsupported response format.

For error code 51, the error description displays the CIP response error code and description as documented in the CIP Common Specification, Appendix B.

Any time the Error Code is nonzero, the EEM error (ER) bit is set.

### *MultiHop Tab*

The MultiHop Tab provides a way for the path to the destination node to be configured. This path can be as simple as the IP address of the destination node, or can include bridging through a Logix gateway to a remote ControlNet destination node or to a remote Ethernet destination node.



### *Send Data Tab*

The Send Data Tab provides a convenient way of viewing and entering in data to be sent along with the explicit message command. The data is shown in byte format with a selectable radix of either Decimal or Hex/BCD. The display only shows the number of words that are defined in the Size in Words (Send Data) field, starting with the low byte of the first word as defined in the Data Table Address (Send Data) field. If the Size in Words is zero, then no data is displayed. You can also change the data being viewed, but only when offline or during an online edit. Click on the data and enter in a byte value based on the current radix (0 to 255 for Decimal and 0 to FF for Hex/BCD). The changed data gets copied to the Send Data data table file when the rung is accepted. To update the Send Data display with the current values stored in the Send Data data table file, click the Refresh button.

### *Receive Data Tab*

The Receive Data Tab provides a convenient way of viewing the data that is returned by the target device in response to the explicit message command sent. The data is shown in byte format with a selectable radix of either Decimal or Hex/BCD. The display shows only the number of words that are defined in the Size in Words (Receive Data) field, starting with the low byte of the first word as defined in the Data Table Address (Receive Data) field. If the Size in Words is zero, then no data is displayed. To update the Receive Data display with the current values stored in the Receive Data data table file, click the Refresh button.

*Control Block Layout*

**Table 12.28 SLC 5/05 EtherNet/IP Explicit Message (EEM) Control Block Structure**

	15	14	13	12	11	10	09	08	07	06	05	04	03	02	01	0
Word 0	EN	ST	DN	ER	CO	EW		TO	Error Code							
Word 1	Extended STS Size (in words)							General STS								
Word 2	Extended Status Debug Word 1															
Word 3	Extended Status Debug Word 2															
Word 4	Total Response Size (in bytes)															
Word 5	Unused															
Word 6	Unused															
Word 7	Unused								Reserved (internal bits)							WQ
Word 8	Reserved (internal bits)								Message Timer Preset							
Word 9	Message Timer Scaled Zero															
Word 10	Message Timer Accumulator															
Word 11	Reserved (internal bits)															
Word 12	AO=0	Reserved (internal bits)														
Word 13	Reserved (internal bits)															
Word 14	1st byte of IP Address String								2nd byte of IP Address String							
Word 15	3rd byte of IP Address String															
-----																
Word 34	41st byte of Address String								NULL byte of Longest String							
Word 35	Unused								Message Type = 0 x 13							
Word 36	ASA Service Code								Internal Object Identifier (IOI): Size							
Word 37	Internal Object Identifier (0)															
Word 38	Internal Object Identifier (1)															
Word 39	Internal Object Identifier (2)															
Word 40	Internal Object Identifier (3)															
Word 41	Internal Object Identifier (4)															
Word 42	Reserved								Connection Path Size in Words							
Word 43	Connection Path (0)															
Word 44	Connection Path (1)															
Word 45	Connection Path (2)															
-----																
Word 57	Connection Path (14)															

## SLC Communication Channels

Use the information in this chapter to understand how to configure and monitor the SLC 500 communication channels including passthru. The following communication drivers are supported.

**Table 13.1 Supported Communication Drivers**

Communication Drivers		SLC 500 Fixed	SLC 5/01	SLC 5/02	SLC 5/03	SLC 5/04	SLC 5/05	Page
Channel 1	DH-485	x	x	x	x			13-7
	DH+					x		13-12
	Ethernet						x	13-24
Channel 0	DH-485				x	x	x	13-7
	DF1 Full-duplex				x	x	x	13-49
	DF1 Half-duplex Master				x <sup>(1)</sup>	x	x	13-56
	DF1 Half-duplex Slave				x	x	x	13-69
	DF1 Radio Modem				x <sup>(2)</sup>	x <sup>(5)</sup>	x <sup>(6)</sup>	13-76
	Modbus RTU Master				x <sup>(3)</sup>	x <sup>(3)</sup>	x <sup>(3)</sup>	13-90
	ASCII				x <sup>(4)</sup>	x	x	13-98

<sup>(1)</sup> OS302, Series A, FRN 9 and higher.

<sup>(2)</sup> OS302, Series C, FRN 6 and higher.

<sup>(3)</sup> OS302 Series C / OS401 Series C / OS501 Series C, FRN 11 and higher

<sup>(4)</sup> OS301 Series A, FRN 5 and higher.

<sup>(5)</sup> OS401, Series C, FRN 6 and higher.

<sup>(6)</sup> OS501, Series C, FRN 6 and higher.

## Communication Driver Overview

**DH-485** - The SLC 500 Fixed, SLC 5/01, SLC 5/02 and SLC 5/03 have a dedicated channel for DH-485. SLC 5/03, SLC 5/04 and SLC 5/05 RS-232 channel 0 can be reconfigured for DH-485. This network is a multi-master, token-passing network protocol capable of supporting up to 32 devices (nodes). This protocol allows:

- monitoring of data and processor status, along with program uploading and downloading of any device on the network from one location.
- SLC processors to pass data to each other (peer-to-peer communication).
- operator interface devices on the network to access data from any SLC processor on the network.

**Data Highway Plus (DH+)** - The Data Highway Plus protocol is used by the SLC 5/04 processor. This protocol is similar to DH-485, except that it can support up to 64 devices (nodes) and runs at faster communication (baud) rates.

**Ethernet** - The Ethernet TCP/IP protocol is used by the SLC 5/05 processor. Standard Ethernet, utilizing the TCP/IP protocol, is used as the backbone network in many office and industrial buildings. Ethernet is a local area network that provides communication between various devices at 10 Mbps or higher. This network provides the same capabilities as DH+ or DH-485 networks, plus:

- SNMP support for Ethernet network management.
- optional dynamic configuration of the processor IP address using BOOTP or DHCP.
- ability to message entire SLC 5/05 data files.
- an unlimited number of nodes on a single network are possible compared to DH-485 (32) and DH+ (64).
- 64 maximum message connections opened at one time (for 64 K processors); 4 incoming, 4 outgoing and 56 either incoming or outgoing.

**DF1 Full-duplex** - DF1 Full-duplex protocol (also referred to as DF1 point-to-point protocol) allows two devices to communicate with each other at the same time. This protocol allows:

- transmission of information across full-duplex modems (dial-up, leased line, radio, or direct cable connections).
- communication to occur between Allen-Bradley products and third-party products.

**DF1 Half-duplex (Master and Slave)** - DF1 Half-duplex protocol provides a multi-drop single master/multiple slave network capable of supporting up to 255 devices (nodes). This protocol also provides modem support and is ideal for SCADA (Supervisory Control and Data Acquisition) applications because of the multidrop capability.

**DF1 Radio Modem** - DF1 Radio Modem protocol is a peer-to-peer protocol that supports up to 255 devices (nodes) and is optimized for radio modem communications. It allows Report-by-Exception messaging; any node can initiate to any other node at any time (as long as the radio modem network supports full-duplex data port buffering and radio transmission collision avoidance). It also supports Store and Forward, which allows messages between two out-of range nodes to be routed through one or more in-range nodes.

**Modbus RTU Master** - Modbus protocol exchanges message instructions to transfer information between the data files in the Modbus RTU Master and the Modbus RTU Slaves.

**ASCII** - The ASCII protocol provides connection to other ASCII devices, such as bar code readers, weigh scales, serial printers, and other intelligent devices.

## DH-485 Communications

The DH-485 network offers:

- interconnection of 32 devices.
- multi-master capability.
- token passing access control.
- the ability to add or remove nodes without disrupting the network.
- maximum network length of 1219 m (4,000 ft).

### DH-485 Network Protocol

The following section describes the protocol used to control message transfers on the DH-485 network. The protocol supports two classes of devices: initiators and responders. All initiators on the network get a chance to initiate message transfers. To determine which initiator has the right to transmit, a token passing algorithm is used.

#### *DH-485 Token Rotation*

A node holding the token can send valid packets onto the data link. The token hold parameter determines the number of transmissions allowed (plus retries) each time the node receives the token.

After a node sends one message packet, it attempts to give the token to its successor by sending a token pass packet. If no network activity occurs, the initiator attempts to find a new successor.

The node address range for an initiator is 0 to 31. The node address range for all responders is 1 to 31. There must be at least one initiator on the network.

**TIP**

The maximum address that the initiator searches for before wrapping to zero is the value in the configurable parameter maximum node address. The default value of this parameter is 31 for all initiators and responders.

SLC 500 processors do not allow node address zero to be applied. If you attempt to apply a zero, node address one becomes the processor node address. Node address zero is reserved for a programming device, such as the Hand-Held Terminal (HHT) or personal computer running programming software.

### *DH-485 Network Initialization*

Network initialization begins when a period of inactivity exceeds the time of a link dead timeout. When the time for the link dead timeout is exceeded, usually the initiator with the lowest address claims the token.

Building a network begins when the initiator that claimed the token tries to pass the token to the successor node. If the attempt to pass the token fails, or if the initiator has no established successor (for example, when it powers up), it begins a linear search for a successor starting with the node above it. It will wrap to node 0 upon reaching its maximum node address value.

When the initiator finds another active initiator, it passes the token to that node, which repeats the process until the token is passed all the way around the network to the first node. At this point, the network is in a state of normal operation.

## **DH-485 Network Considerations**

DH-485 Network considerations include the configuration of the network and the parameters that can be set to the specific requirements of the network. The following are major configuration factors that have a significant effect on network performance.

- Number of nodes on the network
- Addresses of those nodes
- Baud rate
- Maximum node address selection
- SLC 5/03 and higher - token hold factor
- Maximum number of communicating devices
- Broadcasting

The following sections explain network considerations and describe ways to select parameters for optimum network performance (speed).

### *Number of Nodes*

The number of nodes on the network directly affects the data transfer time between nodes. Unnecessary nodes (such as a second programming terminal that is not being used) slow the data transfer rate. The maximum number of nodes on the network is 32.

### *Setting Node Addresses*

The best network performance occurs when node addresses start at 0 and are assigned in sequential order. SLC 500 processors default to node address 1. The node address is stored in the processor status file (S:15L). Processors cannot be node 0. Also, initiators such as personal computers should be assigned the lowest numbered addresses to minimize the time required to initialize the network.

If some nodes are connected on a temporary basis, do not assign addresses to them. Simply create nodes as needed and delete them when they are no longer required.

### *Setting Processor Baud Rate*

The best network performance occurs at the highest baud rate. All devices must be at the same baud rate. The default DH-485 baud rate for SLC 500 devices is 19.2K baud. The baud rate is stored in the processor status file (S:15H).

### *Maximum Node Address Setting*

The maximum node address parameter should be set as low as possible. This minimizes the amount of time used in soliciting successors when initializing the network. If all nodes are addressed in sequence from 0, and the maximum node address is equal to the address of the highest addressed node, the token rotation will improve by the amount of time required to transmit a solicit successor packet plus the slot timeout value.

### *Maximum Number of Communicating Devices*

SLC 500 fixed and SLC 5/01 processors can be selected by no more than two initiators at the same time. Using more than two initiators to select the same SLC 500 fixed and SLC 5/01 processors at the same time can cause communication time-outs.

### *Broadcasting*

A broadcast write command is sent as a DH-485 Send Data No Acknowledgement (SDN) packet. No acknowledgement or reply is returned. Broadcasting is the most efficient way to write the same data to multiple devices on the DH-485 network.



## Configuring a Channel for DH-485

To configure an SLC processor channel for DH-485, do the following using your programming software:

To bring up the Channel Configuration interface, double-click on the Channel Configuration icon.

For an SLC 500 Fixed, SLC 5/01 and SLC 5/02 processor, enter in the Baud Rate and Node Address parameters.

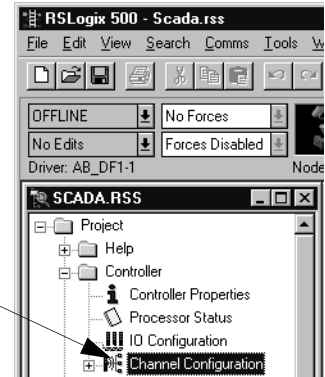

For SLC 5/03, SLC 5/04 and SLC 5/05 processors, define the location of the diagnostic file used for Channel Status here. See Table 13.2 for diagnostic file details.

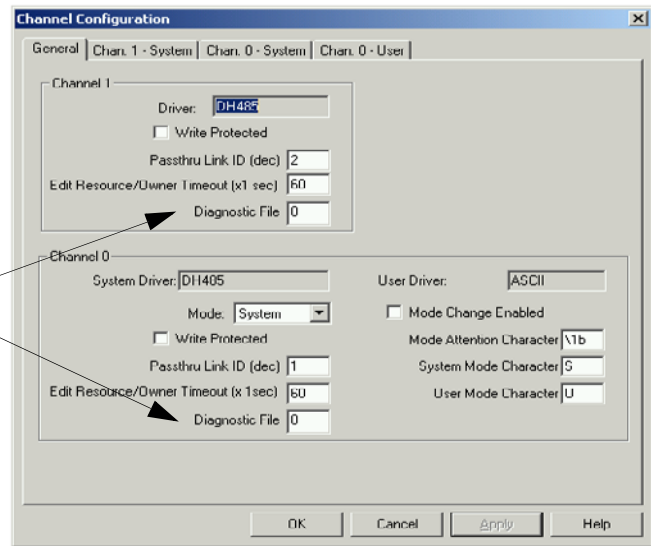

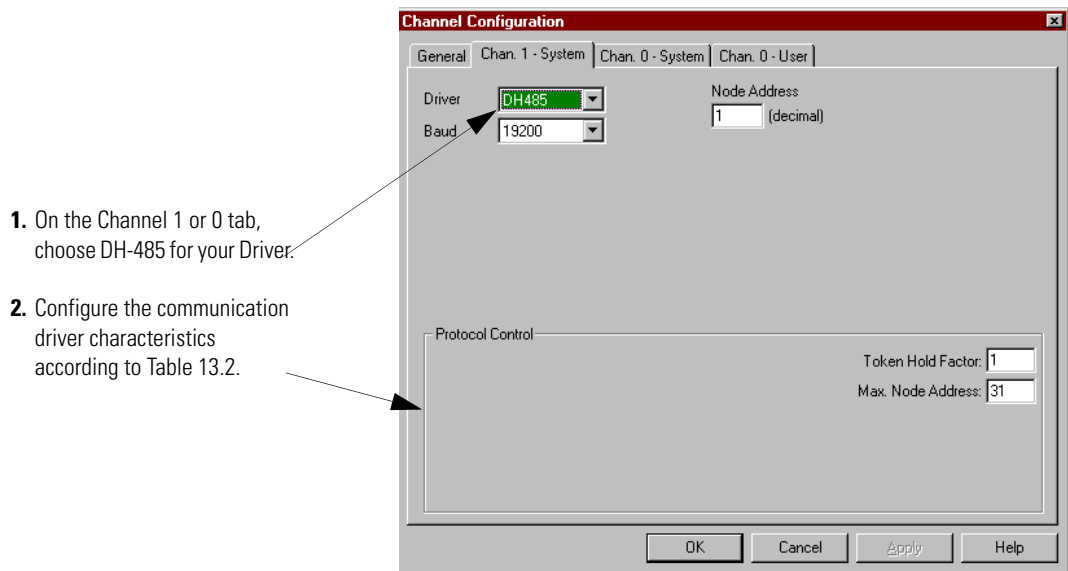

**Table 13.2 Define these communication parameters when configuring an SLC 5/03 or higher processor for DH-485 communications.**

Tab	Parameter	Default	Selections
General	Diagnostic File	0	Select an unused file (9 to 255) to store channel status information. You must define a diagnostic file in order to be able to view channel 0 or channel 1 status. See Table 13.3 for a file description.
Channel 0 or Channel 1 System	Baud Rate	19200	Toggles between the communication rate of 1200, 2400, 9600, and 19200.
	Node Address	1	This is the node address of the processor on the DH-485 network. The valid range is 1 to 31.
	Max Node Address	31	This is the maximum node address of an active processor. The valid range is 1 to 31. The SLC 500 Fixed, SLC 5/01 and SLC 5/02 processors are factory set to 31.
	Token Hold Factor	1	Determines the number of transactions allowed to make each DH-485 token rotation. Increasing this value allows your processor to increase its DH-485 throughput. This also decreases throughput to other processors on the DH-485 link. The valid range is 1 to 4 for SLC 5/03 and higher processors. The SLC 500 Fixed, SLC 5/01 and SLC 5/02 processors are factory set to 1.

## DH-485 Channel Status

For SLC 5/03 (OS302, Series C and higher), SLC 5/04 (OS401, Series C and higher) and SLC 5/05, channel status data is stored in the diagnostic file defined on the Channel Configuration screen. Table 13.3 on page 13-9 explains information regarding the diagnostic counter data displayed.

Double-click on the Channel Status icon located beneath the Configuration icon to bring up the Channel Status screen.

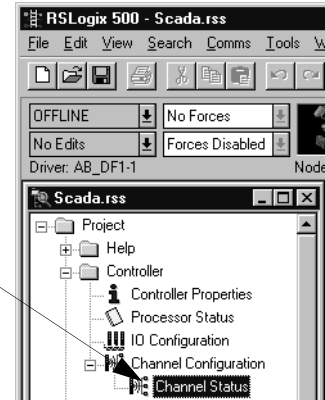

See Table 13.3 for details concerning the DH-485 Channel Status Screen.

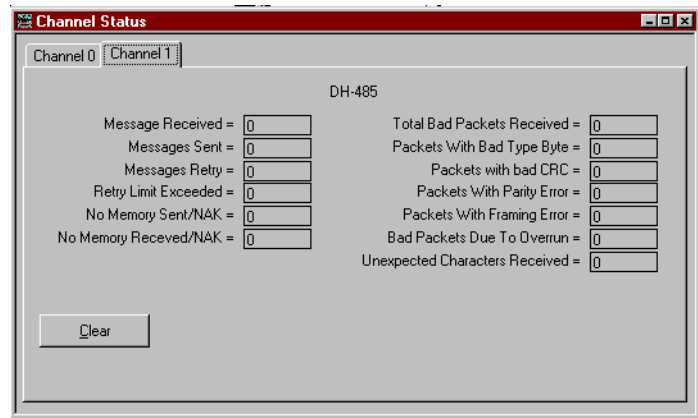

**Table 13.3 SLC 5/03 Channel 1 and SLC 5/03 and Higher Channel 0 DH-485 Channel Status**

Status field	Bytes	Displays the
Messages Received	0,1	Number of error-free messages that the station has received.
Messages Sent	2,3	Number of messages sent by the channel.
Messages Retry	4	Number of messages resent due to errors.
Retry Limit Exceeded	5	Number of times that the processor exceeded its retry limit in trying to send a message.
No Memory Sent/NAK	6	Number of times the processor could not receive a message because it did not have enough memory.
No Memory Received/NAK	7	Number of negative acknowledgements received by the processor.

**Table 13.3 SLC 5/03 Channel 1 and SLC 5/03 and Higher Channel 0 DH-485 Channel Status (Continued)**

Status field	Bytes	Displays the
Total Bad Packets Received	8	Number of incorrect data packets the processor has received.
Packets with bad type byte	9	Number of messages that the processor could not receive because they were of an illegal type that contained a bad control byte.
Packets with bad CRC	10	Number of messages received with a CRC (cyclic redundancy check) transmission integrity error.
Packets with Parity Error	11	Number of messages that could not be processed because of a parity error. Parity is used to detect errors in data bytes. If the parity of a received character is invalid, this counter is incremented.
Packets with Framing error	12	Number of messages containing misaligned data. Each data byte has a start bit and a stop bit. These bits "frame" the actual data byte. If a character is received where these bits are not correctly placed, the character is invalid and this counter is incremented. These errors normally mean an electrically noisy environment or poorly terminated cabling.
Bad Packets due to Overrun	13	Number of messages that could not be handled because the processor could not move data fast enough before new data arrived. In this case data characters are lost and the transmission is bad.
Unexpected Characters Received	14	Number of characters the processor received with parity or with errors and discarded. If this is not zero, it could indicate that an internal hardware problem has occurred. This problem could be that the communication channel's receiver has been disabled, but the DH-485 driver is still receiving characters. If the controller is operating properly, this counter should remain at zero.

For processors running OS Series C, FRN 6 and higher, clicking the Clear button while monitoring Channel Status of either channel 1 or channel 0 online, will reset all of the channel status diagnostic counters for both channels to zero. Prior to OS Series C, FRN 6, the only channel status diagnostic counters that are reset when the Clear button is clicked are the ones on the channel that the programming terminal is connected to. For example, if your programming terminal is connected online via channel 0 and you are monitoring the Channel Status of channel 1, when you click on the Clear button, only channel 0 diagnostic counters will be reset, not channel 1 diagnostic counters.

## Data Highway Plus Communications

Data Highway Plus (DH+) implements peer-to-peer communication with a token-passing scheme to rotate link mastership among a maximum of 64 nodes. Since this method does not require polling, it helps provide time-efficient reliable data transport. The DH+network features:

- remote programming of PLC-5 and SLC 500 processors on your network.
- direct connections to PLC-5 processors and industrial programming terminals.
- easy re-configuration and expansion if you want to add more nodes later.
- communication rates of 57.6K baud, 115.2K baud, or 230.4K baud.

The DH+ network uses factory set time-outs to restart token-passing communication if the token is lost because of a defective or powered down node.

*Example*

The example below shows the connectivity of an SLC 5/04 processor to a PLC-5 processor using the DH+ protocol. A communication rate of 57.6K baud is used.

A Personal Computer with one of the following:

- 1784-KTX (ISA)
- 1784-KTXD (ISA)
- 1784-PKTX (PCI)
- 1784-PKTXD (PCI)
- 1784-PCMKB/B (PCMCIA)

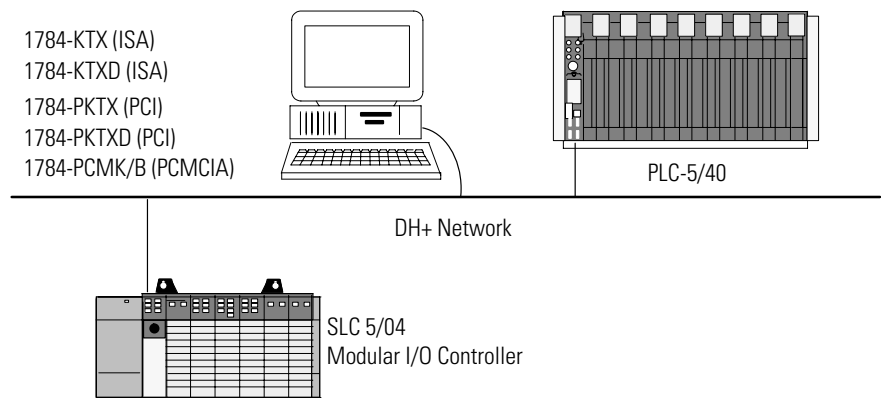

*Example*

The example below shows a DH+ protocol using two SLC 5/04 controllers using the higher baud rates of 115.2K baud or 230K baud.

**TIP**

In the example below, the programming terminal is connected to the serial port of the SLC 5/04 processor to communicate on the DH+ network at the higher baud rate. This method uses the DF1 to DH+ passthru feature.

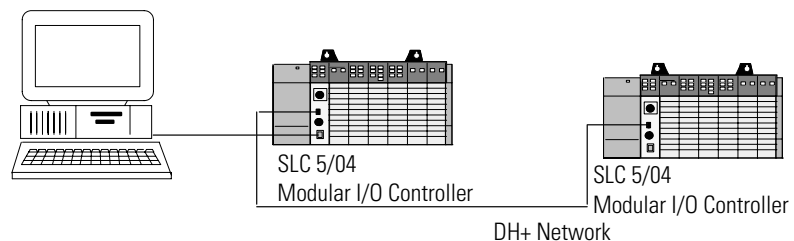

## Configuring Channel 1 for DH+

To configure an SLC 5/04 processor channel for DH+, do the following using your programming software.

To bring up the Channel Configuration interface, double-click on the Channel Configuration icon.

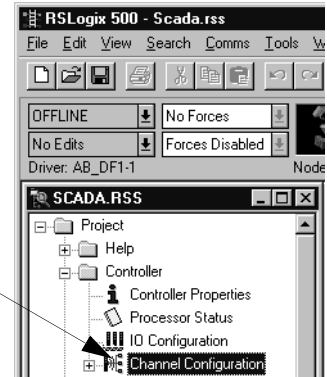

Define the location of the diagnostic file used for Channel Status here. See Table 13.5 on page 13-15 for diagnostic file details.

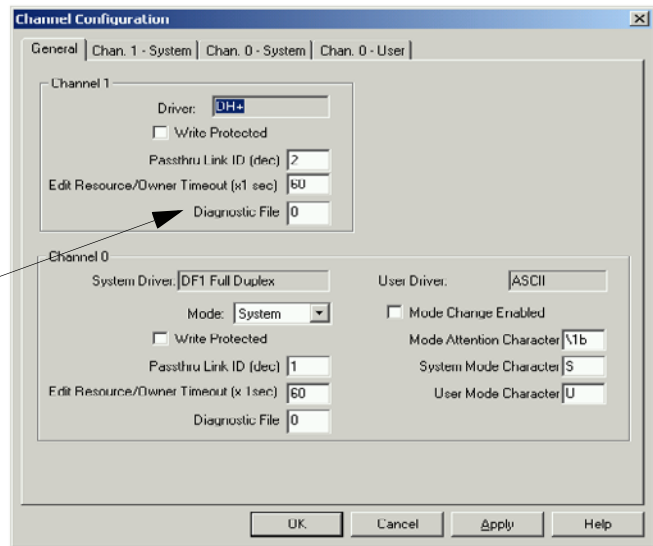

1. On the Channel 1 tab, choose DH+ for your Driver.
2. Configure the communication driver characteristics according to Table 13.4.

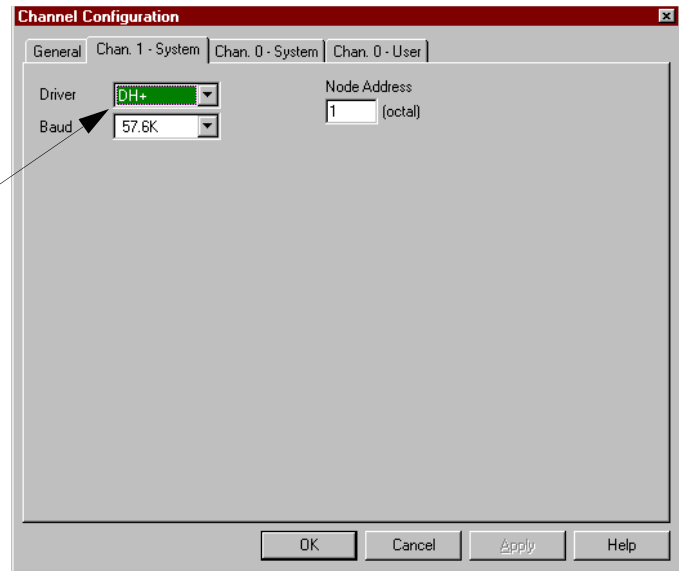

**Table 13.4 Define these communication parameters when configuring an SLC 5/04 for DH+ communications.**

Tab	Parameter	Default	Selections
General	Diagnostic File	0	Select an unused file (9 to 255) to store channel status information. You must define a diagnostic file in order to be able to view channel 1 status. See Table 13.5 for a file description.
Channel 1 System	Baud Rate	57.6k	Toggles between the communication rates of 57.6k, 115.2k and 230.4k.
	Node Address	1	Valid range is 0 to 77 octal.

## DH+ Channel Status

For SLC 5/04 (OS401, Series C and higher), channel status data is stored in the diagnostic file defined on the Channel 1 Configuration screen. See Table 13.5 on page 13-15 for information regarding the diagnostic counter data displayed.

Double-click on the Channel Status Icon Located beneath the Configuration icon to bring up the Channel Status screen.

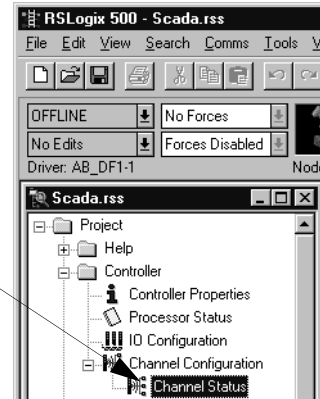

See Table 13.5 for details concerning the DH+ Channel Status Screens for Messages, General, Data Sent with Acknowledgement, and Data Sent without Acknowledgement.

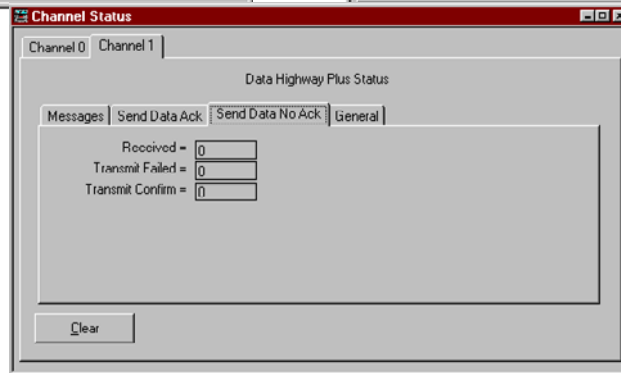
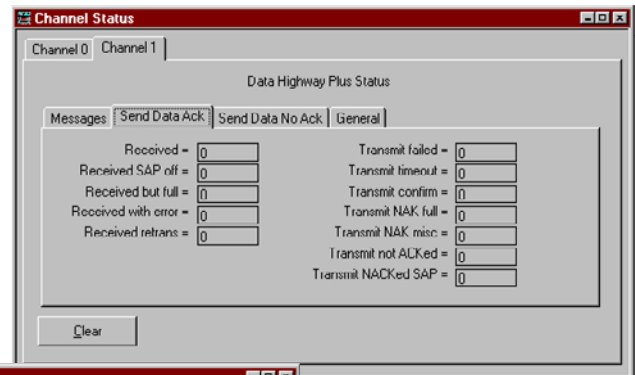
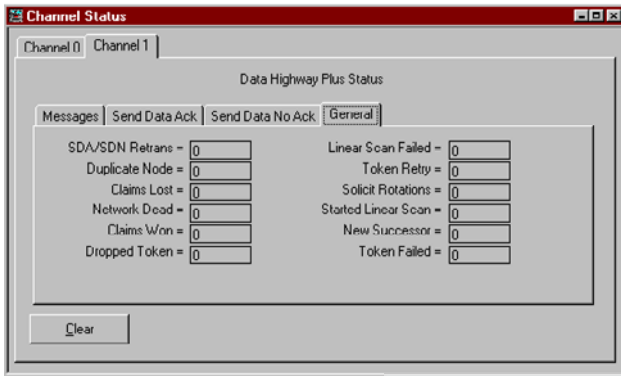
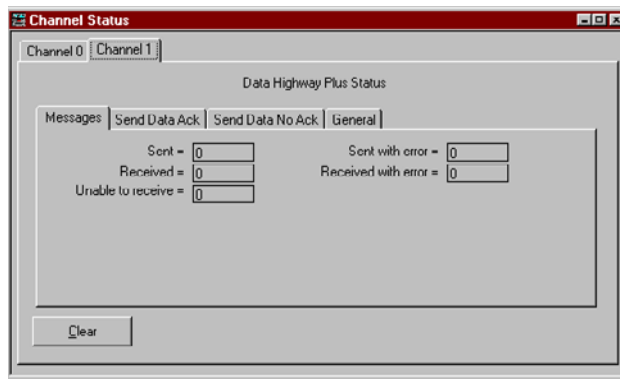



**Table 13.5 SLC 5/04 Channel 1 DH+ Channel Status**

Status field		Word	Displays the
Messages	Received	0	Number of error-free messages the station has received. This number is the sum of the SDA and SDN received counters.
	Sent	1	Total number of messages sent by the station. This number is the sum of the send data acknowledge counters (SDA) and send data no acknowledge (SDN) transmit confirm counters.
	Received with error	2	Number of invalid messages that the station has received. This number is the sum of the SDA received with error and the SDA received SAP off counters.
	Sent with error	3	Number of messages sent that were not acknowledged. This number is the sum of the following. <ul style="list-style-type: none"> <li>• SDA transmit NAK misc</li> <li>• Transmit NAK full</li> <li>• SDA transmit NAKed SAP</li> <li>• SDA/SDN retrans</li> <li>• Dropped token</li> </ul>
	Unable to receive	4	Total number of times the station NAKed an incoming message due to the lack of an available buffer. This number should be the same as the SDA received but full counter.

**Table 13.5 SLC 5/04 Channel 1 DH+ Channel Status (Continued)**

Status field	Word	Displays the
General	Network dead	5 Number of times the station detects no traffic on the network. This usually occurs when the station with the token is powered down or is removed from the network. The other stations are waiting for the token to be passed to them. Eventually a network dead situation is declared and a claim token sequence is initiated. (See claims won for more information.)
	Claims won	6 Number of times the station has won the claim token sequence. All the stations initiated a claim token sequence when a network goes down, is just powered up and the stations on the network detect that no one has the token, or when a station with the token is powered down or removed from the network. A claim token sequence is when all the stations on a network attempt to claim the token. When multiple stations attempt to claim the token, the lowest numbered station wins.
	Claims lost	7 Number of times the station did not win the claim token sequence. See claims won for more information.
	New successor	8 Number of times the station found a new successor for the token. A new successor occurs when the station detects that a new station with a station number between its and a the station it was passing the token to was added to the link. The station now must pass the token to the newly added station.
	Token retry	9 Number of times the station had to re-transmit a token pass. The station re-transmits a token pass if it detects that the station it passed the token to did not receive the token. Noise can cause this to occur.
	Token failed	10 Number of times station could not pass token to its listed successor. This usually occurs due to: <ul style="list-style-type: none"> <li>• the station being removed from the network.</li> <li>• noise or cabling problems.</li> </ul>
	Started linear scan	11 Number of times the station has attempted to pass the token to everyone in its active node table and no one has responded. The station will then start a linear scan where it solicits every station number until a station responds.
	Linear scan failed	12 Number of times the station solicited every station number without getting a response. See started linear scan for more information.
	Duplicate node	13 Number of times the station has detected the same station address as itself on the network. As a result, the station goes offline.
Dropped token	14 Number of times that the station detected that a duplicate node existed on the link and consequently dropped itself off the link.  A station determines that there is a duplicate node when it detects that the response to a message or solicit successor is incorrect. For example, if a response is received from a station which was not communicated with, then the sending station assumes that the response is for a packet sent by another station with the same node number. Once the station drops itself off the link, it waits indefinitely to be solicited back into the network. It will only be solicited back into the network if the duplicate node is removed from the link, because station numbers that already exist on the link are not solicited into the network.	
SDA/SDN retransmissions	24 Total number of SDA or SDN messages that were re-transmitted. Some reasons why the station would retry a message are: <ul style="list-style-type: none"> <li>• the ACK was lost or corrupted on an SDA message, indicating a possible noise problem.</li> <li>• the original message was NAKed.</li> </ul>	

**Table 13.5 SLC 5/04 Channel 1 DH+ Channel Status (Continued)**

Status field		Word	Displays the
General	Solicit rotations	30	Number of times a complete solicit successor of all stations not on the link is completed. A solicit successor occurs during a token pass around the link. Here a station that is currently not on the link is solicited to see if it has been added to the link. During each token pass, a different station number is solicited; solicitation occurs sequentially. A station can only join the link when it is solicited into it.
Data Sent with Acknowledgement (SDA)	Received	15	Number of error-free SDA messages that the station received.
	Received with error	16	Number of invalid SDA messages that the station received. Some causes are: <ul style="list-style-type: none"> <li>• bad CRC.</li> <li>• the message has an invalid source address.</li> <li>• the message has an unrecognizable control byte.</li> <li>• the transmission was aborted.</li> </ul> This counter indicates noise; increase the cable's shielding from noise.
	Received retransmissions	17	Number of times the sending station re-transmitted an SDA message, which was ACKed or NAKed. If node sends a message but does not receive an ACK or a NAK response, the node will re-transmit the message. If a node retransmitted a message because the acknowledge response to the first message was lost, the node receiving the message detects the retransmission and sends an acknowledge response. But the receiving node discards the duplicate message. High counts of this counter indicates noise or cable problems; check that the cable is secure and properly shielded from noise.
	Received but full	18	Number of SDA messages that the station could not receive because of lack of memory.
	Received SAP off	19	Number of SDA messages that the station received but could not process because its service access point (SAP) was off.  This counter should always be 0.
	Transmit confirm	20	Number of SDA messages successfully sent to and acknowledged by the addressed station.
	Transmit NAK misc.	21	Number of incoming SDA messages that were NAKed due to reasons other than the NAKed full and NAKed inactive counters (for example, a NAK due to a bad CRC).
	Transmit time-out	22	Number of SDA messages that were sent but not ACKed or NAKed by the receiving station. This counter increments even if the message does get through during a retry and if the receiving station is unable to communicate. This counter indicates a noise or a cabling problem (the receiving station is not seeing the messages).
Transmit not ACKed	23	Number of SDA messages that were sent but were not ACKed by the receiving station. The following could have occurred. <ul style="list-style-type: none"> <li>• Message could have been NAKed</li> <li>• An invalid ACK was returned</li> <li>• Nothing was returned</li> </ul> This counter can indicate: <ul style="list-style-type: none"> <li>• a noise or a cabling problem.</li> <li>• the receiving station has been removed from the link.</li> <li>• the receiving station cannot communicate.</li> </ul>	

**Table 13.5 SLC 5/04 Channel 1 DH+ Channel Status (Continued)**

Status field		Word	Displays the
Data Sent with Acknowledgement (SDA)	Transmit failed	25	Number of SDA messages sent by the station that were determined to be in error. This counter is the sum of the SDA transmit not ACKed and SDA transmit time-out counter.
	Transmit NAK full	26	Number of times the station received NAK to a message because the destination station was full. This indicates that messages are being sent to the receiving station faster than the processor can process them. Most likely, more than one station on the DH+ link is sending messages to the same station. Check to see that you are: <ul style="list-style-type: none"> <li>not scheduling unnecessary traffic (for example, you are sending continuous messages when you only need updates once per second).</li> <li>implementing report-by-exception so that data is sent only if it is new data.</li> </ul>
	Transmit NAKed SAP	27	Number of SDA messages that were successfully sent to but were NAKed by the addressed station because the SAP specified in the message was illegal. This counter should always be 0.
Data Sent without Acknowledgement (SDN)	Transmit confirm	28	Number of valid SDN messages sent by the station.
	Transmit failed	29	Number of SDN messages sent by the station that were in error. This error should never be seen.
	Received	31	Number of valid SDN messages received.

For processors running OS Series C, FRN 6 and higher, clicking the Clear button while monitoring Channel Status of either channel 1 or channel 0 online, will reset all of the channel status diagnostic counters for both channels to zero. Prior to OS Series C, FRN 6 the only channel status diagnostic counters that are reset when the Clear button is clicked are the ones on the channel that the programming terminal is connected to. For example, if your programming terminal is connected online via channel 0 and you are monitoring the Channel Status of channel 1, when you click on the Clear button, only channel 0 diagnostic counters will be reset, not channel 1 diagnostic counters.

## Global Status Word Overview

When a processor passes the DH+ token to the next node, it can also send a 16-bit word called the Global Status Word (GSW). Every node on the network sees the token pass message, but only the “next” node on the network accepts the token. However, all of the nodes on the network read the Global Status Word sent with each token pass and save it to memory. Each processor on the DH+ network has a table in memory to store Global Status Word(s) it receives from other nodes. In each SLC 5/04 processor’s status file, there is a designation for the:

- Global Status Word.

This word is located in memory at S:99. If S:34/3 is set, data in this memory location is transmitted every time the processor passes the DH+ token. Note that all other DH+ nodes see this data.

- Global Status File.

This file is located in memory at S:100 to S:163, representing one memory location for each of the 64 possible nodes on the DH+ network. As other nodes transmit Global Status information with their token passes, the SLC 5/04 processor collects this information and stores it in the Global Status File. Memory location S:100 corresponds to node #0 (octal), S:101 corresponds to node #1 (octal), and S:163 corresponds to node #77 (octal).

One word of every node's Global Status File is updated each token pass. This can function as a high-speed broadcast message, useful for status passing and synchronization of processors.

If the Global Status Word Transmit Enable bit (S:34/3) and Global Status Word Receive bit (S:34/4) are never set, you can use the Global Status File (S:100 to S:163) for other storage uses. If these bits are reset, this area in the System Status File is never altered by the SLC 5/04 processor, even after a power cycle to the processor.

### *S:34/3 Global Status Word Transmit Enable Bit*

Transmission of the Global Status Word is enabled by setting bit S:34/3 in the status file. If this bit is set (1), the processor transmits the data in S:99 with every DH+ token pass. If this bit is not set (0), the processor passes the token and does not attach the Global Status Word. This bit is dynamically configurable and the default setting is zero. Keep the following guidelines in mind when using the Global Status Word Transmit Enable bit.

- If this bit is not set, the DH+ Token Pass transmitted out Channel 1 will contain no Global Status Word bytes
- If this bit is set, but the SLC 5/04 *is not* in RUN mode, REMote Run, or one of the three test modes, the DH+ Token Pass transmission will contain a 2-byte Global Status Word of 0x0000.
- If this bit is set and the SLC 5/04 *is in* RUN mode, REMote Run, or one of the three tests modes the DH+ Token Pass transmission will contain a 2-byte GSW equal to the value in S:99 (Global Status Word). The word is also placed in the 64-word Global Status File (S:100 to S:163) in the location corresponding to the DH+ node address associated with the SLC 5/04 processor.

For example, if the SLC 5/04 processor is operating at octal address 22 (18 decimal), the transmitted GSW is written to word S:118.

- The word in the Global Status File corresponding to the SLC 5/04 processor's DH+ address will be set to 0x0000 if any thing is done to inhibit the transmission of the Global Status Word from S:99. This includes:
  - clearing S:34/3, Global Status Word Transmit Enable bit
  - placing the SLC 5/04 into a mode other than Run mode or Test mode
  - disabling Channel 1
  - an error occurring on the DH+ link to cause the Channel 1 LED to flash red or go solid red (This could be caused by a duplicate node address.)
  - having an OS400 user program downloaded to the SLC 5/04 processor
- If S:34/3 is not set from the time the SLC 5/04 is powered up, the word corresponding to its DH+ address in the Global Status File will never be written to during the end-of-scan.

#### *S:34/4 Global Status Word Receive Enable Bit*

Receiving the Global Status Words of other processors on the network is enabled by setting bit S:34/4 in the status file. If this bit is set (1), the processor fills in the Global Status File with Global Status Words transmitted by other processors on the network. If this bit is not set (0), the processor ignores any Global Status Word activity on the network. This bit is dynamically configurable and the default setting is zero. Note that transmitting and receiving Global Status Words are independent of each other.

Keep the following guidelines in mind when using the Global Status Word Receive Enable bit:

- If this bit is not set, the Global Status File (S:100 to S:163) is not updated with Global Status Word information being passed on the link.
- An error occurring on the DH+ link to cause the Channel 1 LED to flash red or go solid red disables Global Status Word receptions. (This could be caused by a duplicate node address.)
- Global Status File (S:100-S:163) support is enabled when the following four conditions are met:
  - Channel 1 is configured for DH+ protocol communication
  - the System Status File is at least 164 words in length
  - the Global Status Word Receive Enable bit (S:34/3) is set
  - operation on the DH+ link is working (Channel 1 LED is green)
- Global Status Word reception will not occur while downloading a program.

Note that all 164 words are updated during each end-of-scan. The following table describes possible states of the DH+ node address and the value written to the Global Status Word (S:99).

**Table 13.6 DH+ Node Address State**

State of the DH+ Node Address	Value written into S:99 by the SLC 5/04 processor
Device is not active on the DH+ link	0x0000
Device is active on the DH+ link, but not sending GSW bytes in its Token Pass	0x0000
Device is active on the DH+ link and is sending 1 byte of GSW data in its Token Pass	High byte is set to 0x00; Low byte is set equal to 1 byte of GSW data
Device is active on the DH+ link and is sending 2 bytes of GSW data in its Token Pass	High byte is set equal to the second byte; Low byte is set equal to the first byte (or High and Low bytes are set equal to each other)
Device is active on the DH+ link and is sending 3 or 4 bytes of GSW data in its Token Pass	High byte is set equal to the second byte; Low byte is set equal to the first byte, and the third and fourth bytes are ignored

- If the Global Status File (S:100-S:163) is working and then Channel 1 is disabled, the entire Global Status File is zeroed out.
- If the Global Status File (S:100-S:163) is working and bit S:34/4 is reset, the entire Global Status File is zeroed out except for the one word corresponding to the Channel 1 DH+ node address.
- If the Global Status File (S:100-S:163) is working and then a DH+ link error occurs, the entire Global Status File is zeroed out. If the SLC 5/04 processor recovers from the error on its own, then the Global Status File updating resumes automatically.
- If the Global Status File (S:100-S:163) is working and then a user program with a System Status File of less than 164 words is downloaded, the SLC 5/04 processor detects this before any further updating of the Global Status File is attempted. In other words, no corruption of the user program results even if all other criteria are still met to support the GSW reception table feature.

**TIP**

The SLC 5/04 processor maintains a working Global Status Word table regardless if Channel 1 DH+ Active Node Table operation is enabled, (by setting S:34/1).

## Ethernet Communications

This section:

- describes SLC 5/05 performance considerations.
- describes Ethernet network connections and media.
- explains how the SLC 5/05 establishes node connections.
- lists Ethernet configuration parameters and procedures.
- describes configuration for subnet masks and gateways.

The SLC 5/05 supports Ethernet communication via the Ethernet communication channel 1. Ethernet is a local area network that provides communication between various devices at 10 Mbps or higher. The physical communication media options for the SLC 5/05 are:

- built-in.

10/100 Mbps twisted pair (10Base-T/100Base-Tx)

- with media converters, hubs, or switches.
  - fiber optic
  - broadband
  - thick-wire coaxial cable (10Base-5)
  - thin-wire coaxial cable (10Base-2)
  - 1,000 Mbps twisted pair (1000Base-T)

## SLC 5/05 Performance Considerations

Actual performance of an SLC 5/05 processor varies according to:

- size of Ethernet messages.
- frequency of Ethernet messages.
- network loading.
- the implementation and performance of your processor application program, including status file bit settings.

For the best channel 1 Ethernet performance, clear both the channel 1 Communications Servicing Selection bit S:2/15, and the channel 1 Message Servicing Selection bit, S:33/7. Refer to Appendix A for additional information regarding these status file bits.



*Optimal Performance: PC to SLC 5/05 Processor (2-node Ethernet network)*

**Table 13.7 Optimal Performance: RSLinx to SLC 5/05 Processor (2-node Ethernet network)**

Operation	Words	MSG per Second	Words per Second
Single Typed Read	1	105	105
Single Typed Read	20	99	1980
Single Typed Read	100	86	8600
Single Typed Read	256	71	18176

**SLC 5/05 and PC Connections to the Ethernet Network**

TCP/IP is the mechanism used to transport Ethernet messages. The SLC 5/05 processor uses TCP/IP to establish sessions and to send MSG commands. Connections can be initiated by either a client program (INTERCHANGE or RSLinx application) or a processor. Refer to the MSG instruction operation in chapter 12 for information on how connections are established using the MSG instruction.

The SLC 5/05 Ethernet connector conforms to ISO/IEC 8802-3 STD 802.3 and utilizes twisted pair media. Connections are made directly from the SLC 5/05 to an Ethernet hub or switch. The network setup is simple and cost effective. The typical network topology is pictured below, as well as an alternate point-to-point connection using an RJ-45 cross-over cable.

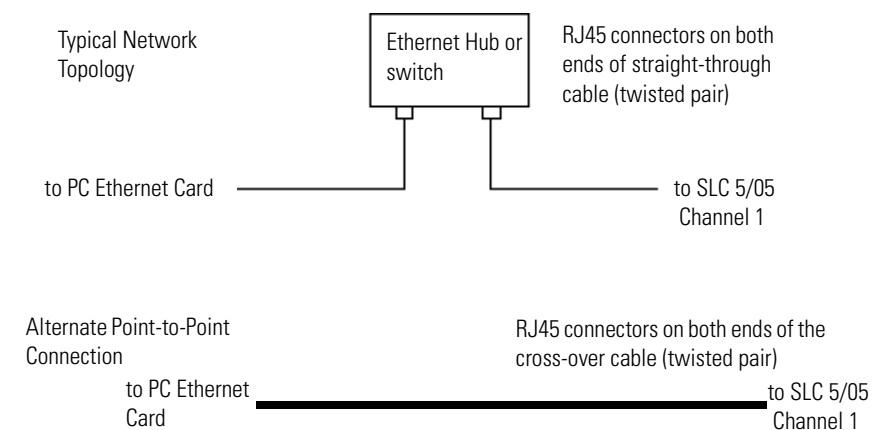

**IMPORTANT**

The SLC 5/05 processor contains an RJ45 Ethernet connector which connects to standard Ethernet switches via 8-wire twisted pair straight-through cable. To access other Ethernet mediums, use RJ45 media converters or Ethernet switches that can be connected together via fiber, thin-wire, or thick-wire coaxial cables, or any other physical media commercially available with Ethernet switches.

There are two ways to configure the SLC 5/05 Ethernet channel 1. The configuration can be done via a BOOTP or DHCP request at processor powerup, or by manually setting the configuration parameters using RSLogix 500 Programming Software (refer to Configuring Channel 1 for Ethernet).

## Configuring Channel 1 for Ethernet

To configure and SLC 5/05 processor channel 1 for Ethernet, do the following using your programming software:

To bring up the Channel Configuration interface, double-click on the Channel Configuration icon.

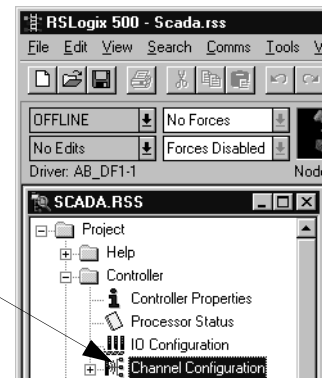

Define the location of the diagnostic file used for Channel Status here. See Table 13.10 on page 13-30 for diagnostic file details.

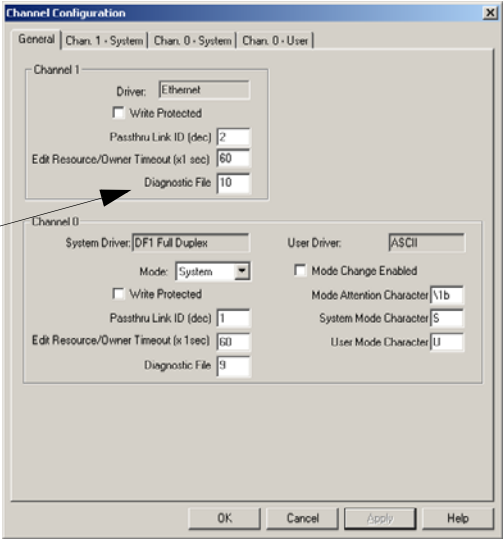

Configure the communication driver characteristics according to Table 13.8.

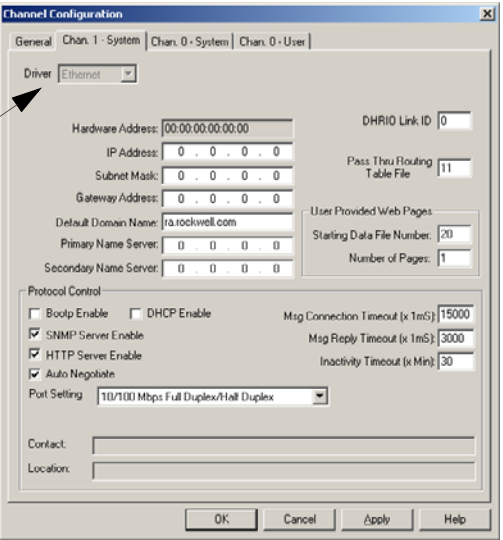

**Table 13.8 Define these communication parameters when configuring an SLC 5/05 processor for Ethernet communications.**

Tab	Parameter	Default	Selections
General	Diagnostic File	0	Select an unused file to store channel status information. You must define a diagnostic file in order to be able to view channel 1 status. The Diagnostic File Number must be an integer within the limits of 9 to 255. See Table 13.10 for a file description.
	Hardware Address	Ethernet hardware address	The SLC 5/05 Ethernet hardware address.
	IP Address	0, 0, 0, 0 (undefined)	The SLC 5/05 internet address (in network byte order). The internet address must be specified to connect to the TCP/IP network.
	Subnet Mask	0, 0, 0, 0	The SLC 5/05 subnet mask (in network byte order). The Subnet Mask is used to interpret IP addresses when the internet is divided into subnets. A Subnet Mask of all zeros indicates that no subnet mask has been configured.
	Gateway Address	0, 0, 0, 0	The address of a gateway (in network byte order) that provides connection to another IP network. A Gateway Address of all zeros indicates that no gateway has been configured.
	Default Domain Name		This is the portion of the Domain Name that is the same for every device on the local Ethernet network. When a target device name is entered in the Ethernet MSG instruction in place of the target device IP address, then the Default Domain Name is appended to the device name when the MSG is triggered and a request is made for the corresponding IP address from the DNS server. The default domain name can have the following formats: 'a.b.c', 'a.b' or 'a', where a, b, c must start with a letter, end with a letter or digit, and have as interior characters only letters, digits or hyphens. Maximum length is 47 characters.
	Primary Name Server <sup>(1)</sup>	0.0.0.0	This is the IP address of the computer acting as the local Ethernet network Primary Domain Name System (DNS) server.
	Secondary Name Server <sup>(1)</sup>	0.0.0.0	This is the IP address of the computer acting as the local Ethernet network Secondary Domain Name System (DNS) server.
	DHRIO Link ID	0	The link ID assigned to this SLC 5/05 in a 1756-DHRIO module routing table so that DH+ devices can initiate communications to this SLC 5/05.
	Pass Thru Routing Table File	0	Enter an integer file from 9 to 255. This file (routing table) stores up to 128 IP addresses that may be accessed by devices connected to channel 0 using either DF1 Full-duplex, DF1 Master, DF1 Radio Modem, or DH-485 protocols.
	User Provided Web Pages Starting Data File Number <sup>(2)</sup>	0 (disabled)	Enter the first in an unused block of data table file numbers within range of 9 to 252. This is the starting data table file number used to store user-provided web pages. Each page is stored in a block of four consecutive 256-element ASCII files.
	User Provided Web Pages Number of Pages <sup>(2)</sup>	1	Enter 1 to 16. This is the total number of user-provided web pages. Each web page allocates four contiguous 256 element ASCII files. All web pages reside in a contiguous block of ASCII files from four to 64 files in length.
Channel 1 System	MSG Connection Timeout	15,000 ms	The amount of time (in ms) allowed for a MSG instruction to establish a connection with the destination node. The MSG Connection Timeout has a range from 250 ms to 65,500 ms.
	MSG Reply Timeout	3,000 ms	The amount of time (in ms) that the SLC 5/05 waits for a reply to a command that it has initiated via a MSG instruction. The MSG Reply Timeout has a range from 250 ms to 65,500 ms. This timeout also applies to Ethernet-to-channel 0 passthru commands.

**Table 13.8 Define these communication parameters when configuring an SLC 5/05 processor for Ethernet communications. (Continued)**

Tab	Parameter	Default	Selections
	Inactivity Timeout <sup>(3)</sup>	30 minutes	The amount of time (in minutes) that a MSG connection may remain inactive before it is terminated. The Inactivity Timeout has a 1 minute resolution and a range from 1 to 65,500 minutes.
	BOOTP Enable	enabled	The BOOTP enable switch. When BOOTP is enabled, the SLC 5/05 attempts to learn its network related parameters at powerup via a BOOTP request. There must be a BOOTP server on the network capable of responding to this BOOTP request. When BOOTP is disabled, the SLC 5/05 uses the locally configured network related parameters (IP Address, Subnet Mask, etc.).
	DHCP Enable <sup>(4)</sup>	disabled	The DHCP enable switch. When DHCP is enabled, the SLC 5/05 attempts to learn its network related parameters at powerup via a DHCP request. There must be a DHCP server on the network capable of responding to this DHCP request. When DHCP is disabled, the SLC 5/05 uses the locally configured network related parameters (IP Address, Subnet Mask, etc.).
	SNMP Server Enable <sup>(5)</sup>	enabled	The SNMP enable switch. When SNMP is enabled, the SLC 5/05 responds to requests from a Simple Network Management Protocol Client.
	HTTP Server Enable <sup>(6)</sup>	enabled	The HTTP enable switch. When HTTP is enabled, the SLC 5/05 web server responds to web browser requests.
	Auto Negotiate and Port Setting <sup>(6)</sup>	Auto Negotiate disabled and Port Setting 10 Mbps/Half-duplex	<p>When Auto Negotiate is disabled (unchecked), the Ethernet speed/duplex is forced to either 10 Mbps/Half-duplex, 10 Mbps/Full-duplex, 100 Mbps/Half-duplex, or 100 Mbps/Full-duplex, as selected in the Port Setting field.</p> <p>When Auto Negotiate is enabled (checked), the Port Setting Field allows you to select the range of speed/duplex settings that the SLC 5/05 will negotiate.</p> <p>Refer to table 13.9 for the setting choices and order of negotiation for each setting.</p>

<sup>(1)</sup> Parameter is only functional in OS501, Series C, FRN 5 and higher.

<sup>(2)</sup> Parameter is only functional in OS501, Series C, FRN 6 and higher.

<sup>(3)</sup> Only applies to non-Multi-hop MSGs. Multi-hop MSG Inactivity Timeout is fixed at 4.5 minutes.

<sup>(4)</sup> Parameter is only functional in OS501, Series C, FRN 10 and higher, Series A-C hardware.

<sup>(5)</sup> Parameter is only functional in OS501, Series C, FRN 9 and higher, Series A-C hardware.

<sup>(6)</sup> Parameter is only functional in OS501, Series C, FRN 9 and higher, Series C hardware.

**Table 13.9 Configuration Setting**

Setting	100 Mbps Full-duplex	100 Mbps Half-duplex	10 Mbps Full-duplex	10 Mbps Half-duplex
10/100 Mbps Full-duplex/Half-duplex	1st	2nd	3rd	4th
100 Mbps Full-duplex or 100 Mbps Half-duplex	1st	2nd	-	3rd
100 Mbps Full-duplex or 10 Mbps Half-duplex	1st	-	2nd	3rd
100 Mbps Half-duplex or 10 Mbps Full-duplex	-	1st	2nd	3rd
100 Mbps Full-duplex	1st	-	-	2nd
100 Mbps Half-duplex	-	1st	-	2nd
10 Mbps Full-duplex	-	-	1st	2nd
10 Mbps Half-duplex Only	-	-	-	1st

**IMPORTANT**

Both the SLC 5/05 Channel 1 and its link partner (typically an Ethernet switch) must be configured to Auto Negotiate or to the same forced speed and duplex. Otherwise a reduction in either system performance and/or system reliability may be observed.

**Ethernet Channel Status**

For SLC 5/05 processors, channel status data is stored in the diagnostic file defined on the Channel 0 Configuration screen. See Table 13.10 on page 13-30 for information regarding the diagnostic counter data displayed.

Double-click on the Channel Status icon located beneath the Configuration icon to bring up the Channel Status screen.

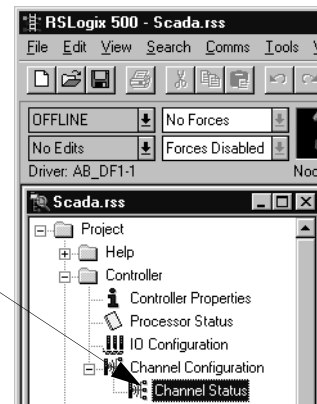

See Table 13.10 for details concerning the Ethernet Channel Status Screen.

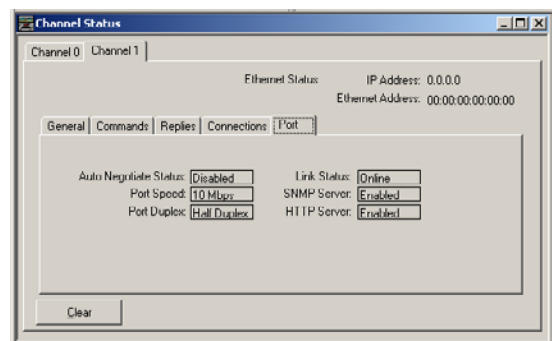
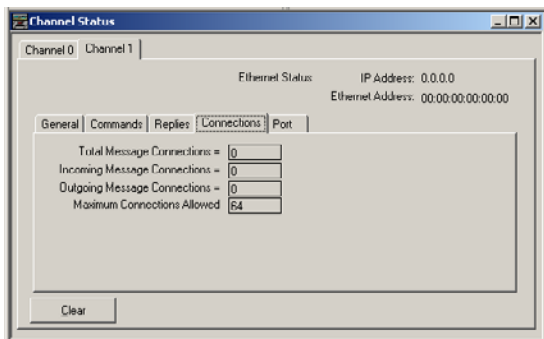
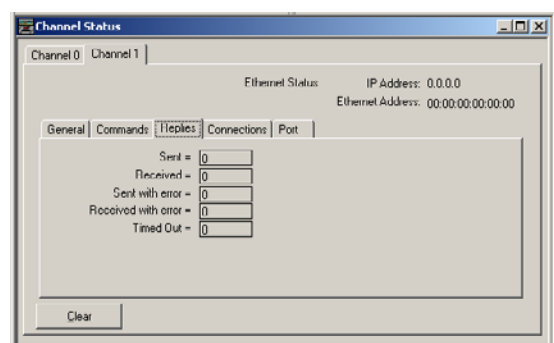
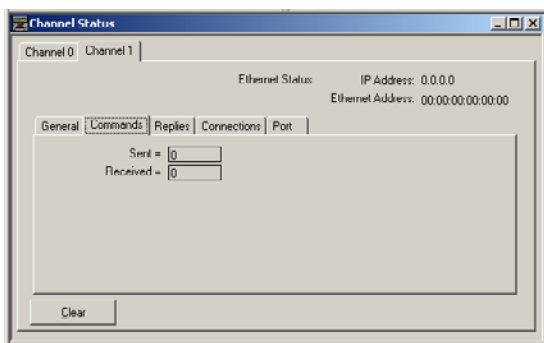
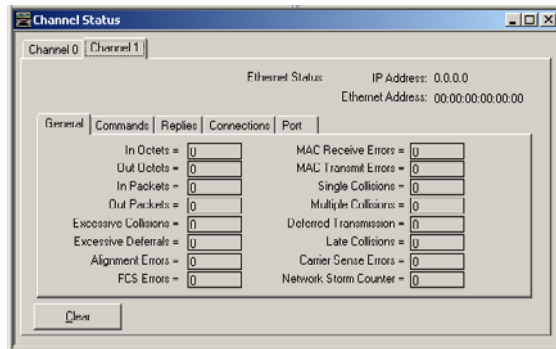

**Table 13.10 SLC 5/05 Channel 1 Ethernet Channel Status**

Status field		Words	Displays the number of
Commands	Sent	0,1	Commands sent by the channel.
	Received	2,3	Commands received by the channel.
Replies	Sent	4,5	Replies sent by the channel.
	Sent with error	6,7	Replies containing errors sent by the channel.
	Received	8,9	Replies received by the channel.
	Received with error	10,11	Replies containing errors received by the channel.
	Timed Out	12,13	Replies not received within the specified time-out period.
General	In Octets	14,15	Octets received on the channel.
	Out Octets	16,17	Octets sent on the channel.
	In Packets	18,19	Packets received on the channel, including broadcast packets.
	Out Packets	20,21	Packets sent on the channel, including broadcast packets.
	Alignment Errors	22,23	Frames received on the channel that are not an integral number of octets in length.
	FCS Errors	24,25	Frames received on the channel that do not pass the FCS check.
	Carrier Sense Errors	26,27	Times that the carrier sense condition was lost or never asserted while trying to transmit a frame.
	Excessive Collisions	28,29	Frames for which a transmission fails due to excessive collisions.
	Excessive Deferrals	30,31	Frames for which transmission is deferred for an excessive period of time.
	MAC Receive Errors	32,33	Frames for which reception on an interface fails due to internal MAC sublayer receive error.
	MAC Transmit Errors	34,35	Frames for which reception on an interface fails due to internal MAC sublayer transmit error.
	Single Collisions	36,37	Successfully transmitted frames for which transmission was delayed because of collision.
	Multiple Collisions	38,39	Successfully transmitted frames for which transmission was delayed more than once because of collision.
	Deferred Transmission	40,41	Frames for which the first transmission attempt is delayed because the medium is busy.
	Late Collisions	42,43	Times that a collision is detected later than 512 bit-times into the transmission of a packet.
Network Storm <sup>(2)</sup>	44	Times that extremely high levels of Ethernet traffic, or network storms, have been detected.	
Ethernet (Hardware) Address <sup>(2)</sup>	45 through 47	Processor's Ethernet hardware address, which is unique to every processor.	
(assigned) IP Address <sup>(2)</sup>	48,49	Each of the four bytes holds one of the numbers of the assigned IP address in hex in the dot address format. For example, an IP address of 142.169.121.1 will be displayed in hex as 8EA97901.	



**Table 13.10 SLC 5/05 Channel 1 Ethernet Channel Status (Continued)**

Status field		Words	Displays the number of
Connections	Total Message Connections <sup>(2)</sup>	50	Total existing Ethernet message connections.
	Incoming Message Connections <sup>(2)</sup>	51	Existing incoming Ethernet message connections.
	Outgoing Message Connections <sup>(2)</sup>	52	Existing outgoing Ethernet message connections.
	Maximum Connections Allowed <sup>(3)</sup>	53	Maximum number of connections allowed.
Port <sup>(1)</sup>	Auto Negotiate Status	54; bit 4	0 = Disabled, 1 = Enabled
	Port Speed	54; bit 2	0 = 10 Mbps, 1 = 100 Mbps
	Port Duplex	54; bit 3	0 = Half-duplex, 1 = Full-duplex
	Link States	54; bit 5	0 = Online, 1 = Offline
	SNMP Server	54; bit 1	0 = Enabled, 1 = Disabled
	HTTP Server	54; bit 0	0 = Enabled, 1 = Disabled

<sup>(1)</sup> OS501, Series C, FRN9 and higher.

<sup>(2)</sup> OS501, Series C, FRN3 and higher.

<sup>(3)</sup> OS501, Series C, FRN5 and higher.

For processors running OS Series C, FRN 6 and higher, clicking the Clear button while monitoring Channel Status of either channel 1 or channel 0 online, will reset all of the channel status diagnostic counters for both channels to zero. Prior to OS Series C, FRN 6 the only channel status diagnostic counters that are reset when the Clear button is clicked are the ones on the channel that the programming terminal is connected to. For example, if your programming terminal is connected online via channel 0 and you are monitoring the Channel Status of channel 1, when you click on the Clear button, only channel 0 diagnostic counters will be reset, not channel 1 diagnostic counters.

## Configuration Via BOOTP

BOOTP (bootstrap protocol) is a low-level protocol that TCP/IP nodes use to obtain start-up information. By default, the SLC 5/05 broadcasts BOOTP requests at powerup. The BOOTP Valid parameter remains clear until a BOOTP reply has been received. BOOTP lets you dynamically assign IP Addresses to processors on the Ethernet Link.

To use BOOTP, a BOOTP Server must exist on the local Ethernet subnet. The server is a computer that has BOOTP Server software installed and reads a text file containing network information for individual nodes on the network.

The host system's BOOTP configuration file must be updated to service requests from SLC 5/05 processors. The following parameters must be configured.

**Table 13.11 BOOTP Configuration Parameters**

Parameter	Description
IP Address	A unique IP Address for the SLC 5/05 processor.
Subnet Mask	Specifies the net and local subnet mask as per the standard on subnetting RFC 950, Internet Standard Subnetting Procedure.
Gateway	Specifies the IP address of a gateway on the same subnet as the SLC 5/05 that provides connections to another IP network.

**TIP**

You can use any commercially available BOOTP server. If you do not have BOOTP Server capabilities on your network, and you want to dynamically configure Channel 1, you can download the free Rockwell Automation BOOTP server from the Rockwell Automation website. Go to [www.ab.com/networks/bootp/index.html](http://www.ab.com/networks/bootp/index.html)

When BOOTP is enabled, the following events occur at power-up.

- The processor broadcasts a BOOTP-request message containing its hardware address over the local network or subnet.
- The BOOTP server compares the hardware address with the addresses in its look-up table.
- The BOOTP server sends a message back to the processor with the IP address and other network information that corresponds to the hardware address it received.

With all hardware and IP addresses in one location, you can easily change IP addresses in the BOOTP configuration file if your network needs change.

The BOOTP request can be disabled by clearing the BOOTP Enable parameter in the channel Configuration File. When BOOTP Enable is cleared (disabled), the SLC 5/05 uses the existing channel configuration data.

**IMPORTANT**

If BOOTP is disabled, or no BOOTP server exists on the network, you must use SLC 500 programming software to enter/change the IP address for each processor.

## Using the Rockwell BOOTP Utility

The Rockwell BOOTP utility is a standalone program that incorporates the functionality of standard BOOTP software with a user-friendly graphical interface. It is located in the **Utils** directory on the **RSLogix 5000** installation CD. It can also be downloaded from [www.ab.com/networks/bootp/index.html](http://www.ab.com/networks/bootp/index.html) web page. The device must have BOOTP enabled (factory default) to use the utility.

To configure your device using the BOOTP utility:

1. Run the BOOTP software. In the **BOOTP Request History** panel you will see the hardware addresses of devices issuing BOOTP requests.

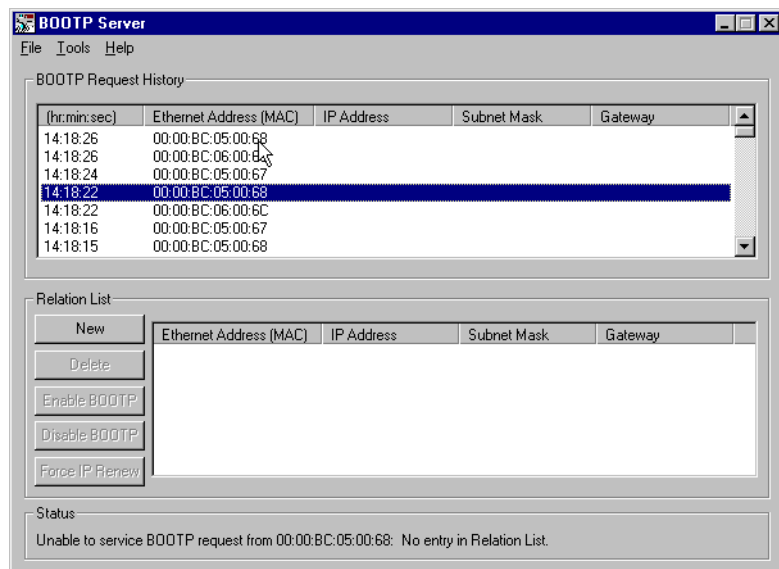

2. Double-click on the hardware address of the device you want to configure. You will see the **New Entry** pop-up window with the device's Ethernet Address (MAC).

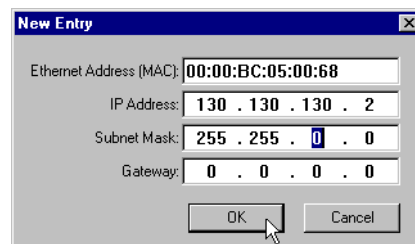

3. Enter the **IP Address**, **Subnet Mask**, and **Gateway** you want to assign to the device, and click on **OK**.

The device will be added to the **Relation List**, displaying the Ethernet Address (MAC) and corresponding IP Address, Subnet Mask, and Gateway (if applicable).

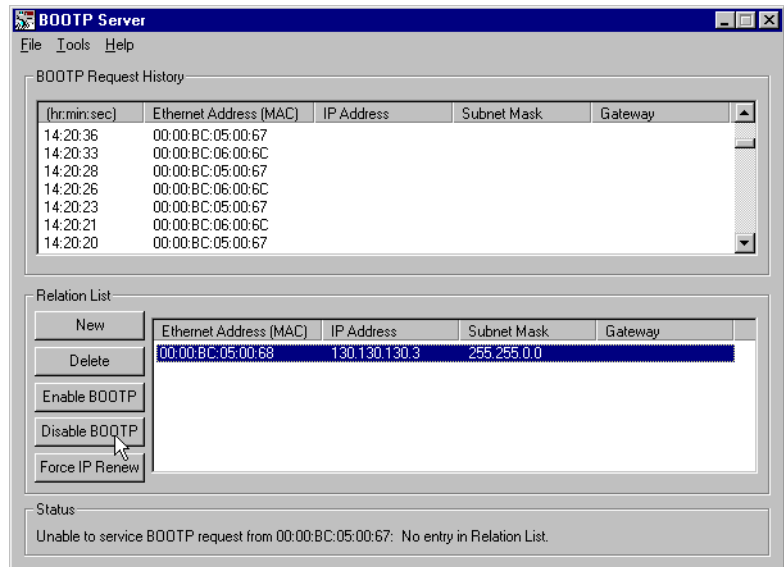

## SLC 5/05 Embedded Web Server Capability

SLC 5/05 processors with OS501, Series C, FRN 6 (or higher) include an enhanced embedded web server (introduced in Series C, FRN 5) which allows viewing of not only module information, TCP/IP configuration, and diagnostic information, but also includes the data table memory map, data table monitor screen, and user-provided web pages via Ethernet using a standard web browser.

In order to view the web server main menu from a standard web browser, type:

`http://www.xxx.yyy.zzz` for the web address

The `www.xxx.yyy.zzz` is the IP address of the SLC 5/05 processor.

The following topics appear on the main menu.

- Module Information
- TCP/IP Configuration
- Diagnostic Information
- Data Table Memory Map
- Data Table Monitor
- User Provided Pages

**Figure 13.1 SLC 5/05 Home Page**

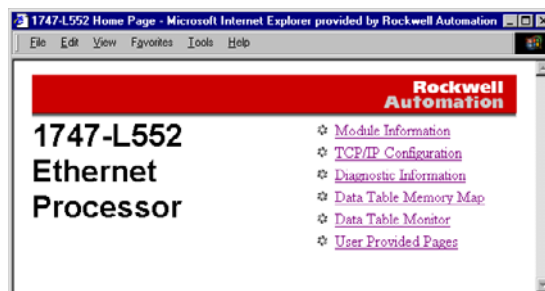

### Module Information

The module information page displays a table with information about the processor. The specific information displayed includes the processor model, series/revision of the processor, mode of the processor and the name of the program in the processor. Also displayed is the revision/build of the Ethernet firmware and the module uptime (time since power was last applied).

**Figure 13.2 SLC 5/05 Module Information Page**

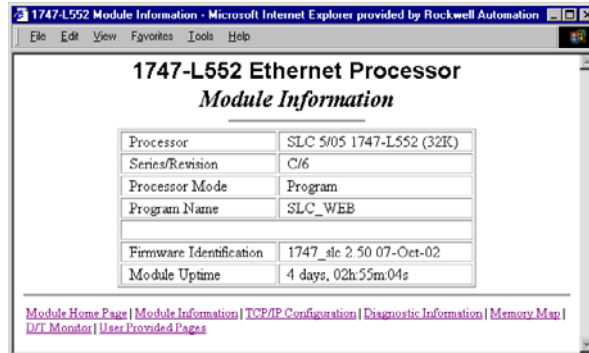

## TCP/IP Configuration

This page displays a table with information about the current TCP/IP configuration parameters. Included are the module's IP address, the subnet mask, gateway address, the Ethernet hardware address and whether BOOTP is enabled. Also included are the name server, secondary name server and the default domain name parameters, if configured.

**Figure 13.3 SLC 5/05 TCP/IP Configuration Page**

### 1747-L552 Ethernet Processor

#### *TCP/IP Configuration*

IP Address	131.200.50.101
Subnet Mask	255.255.254.0
Gateway Address	131.200.50.1
Name Server	0.0.0.0
Secondary Name Server	0.0.0.0
Default Domain Name	* Not Configured *
BOOTP Enable	No
Ethernet Address	00:00:BC:1D:09:9D

[Module Home Page](#) | [Module Information](#) | [TCP/IP Configuration](#) | [Diagnostic Information](#)

## Diagnostic Information

This section gives you access to the various diagnostic information screens that are available. It is divided into two sections, the Network Stack Statistics and Application Level Statistics. The Network Stack Statistics detail information about the TCP/IP stack, while the Application Level Statistics are related to the Allen-Bradley Client Server Protocol (CSP) and Common Industrial Protocol (CIP) diagnostics.

The individual diagnostic screens automatically refresh using a time which is configurable by the user and defaults to 15 seconds.

**Figure 13.4 SLC 5/05 Diagnostic Information Main Page**

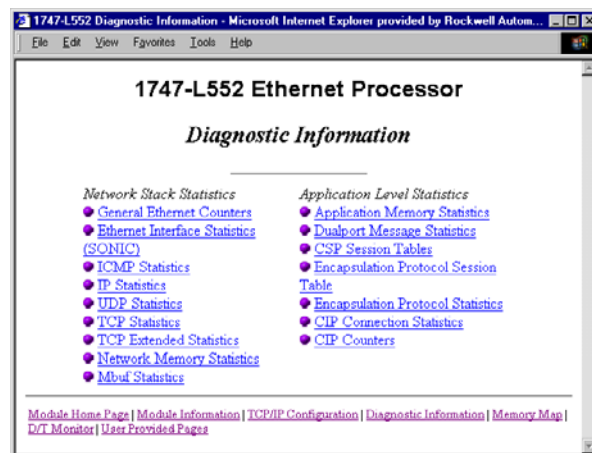

## Data Table Memory Map

The Data Table Memory Map page displays a list of the data table files, their type, and size in elements for a connected SLC 5/05, as shown in the following example.

**Figure 13.5 Data Table Memory Map Page**

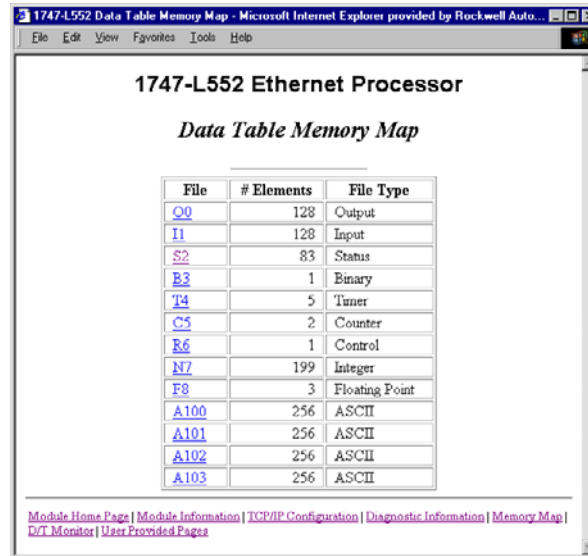

1747-L552 Ethernet Processor

*Data Table Memory Map*

File	# Elements	File Type
<a href="#">Q0</a>	128	Output
<a href="#">I1</a>	128	Input
<a href="#">S2</a>	83	Status
<a href="#">B3</a>	1	Binary
<a href="#">T4</a>	5	Timer
<a href="#">C5</a>	2	Counter
<a href="#">R6</a>	1	Control
<a href="#">N7</a>	199	Integer
<a href="#">F8</a>	3	Floating Point
<a href="#">A100</a>	256	ASCII
<a href="#">A101</a>	256	ASCII
<a href="#">A102</a>	256	ASCII
<a href="#">A103</a>	256	ASCII

[Module Home Page](#) | [Module Information](#) | [TCP/IP Configuration](#) | [Diagnostic Information](#) | [Memory Map](#) | [D/T Monitor](#) | [User Provided Pages](#)



Each file contains a hyperlink that takes you to the specific Data Table Monitor page for that file. When you click on a particular file, the Data Table Monitor page appears, displaying the contents of the data table file you selected.

**Figure 13.6 Data Table Monitor Page**

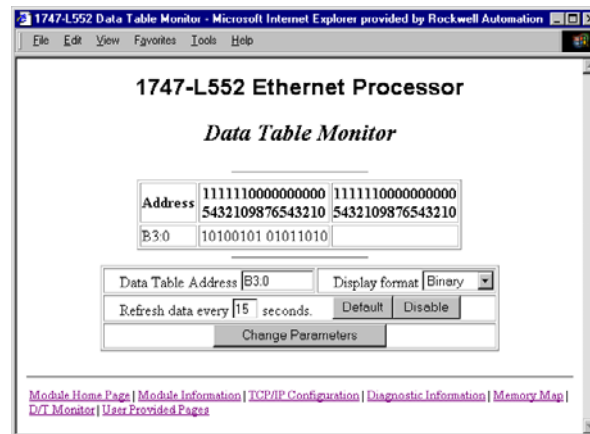

The available and default display formats depend on the data type of the file.

Press the Prev or Next buttons to display the previous or next page of the data table file, if any.

You can change the Data Table Address, Display Format, and Refresh Data Every xx seconds fields by entering data in the text boxes and clicking the Change Parameters button.

To change the refresh data function back to the default of 15 seconds, click the Default field. To disable the refresh data function, click the Disable button.

## Data Table Monitor

You may also go directly to the Data Table Monitor screen by selecting it on the home page or by clicking on D/T Monitor on the bottom row of the other pages. In this case, since a particular data file has not been chosen, a default screen is displayed.

**Figure 13.7 Default Data Table Monitor Screen**

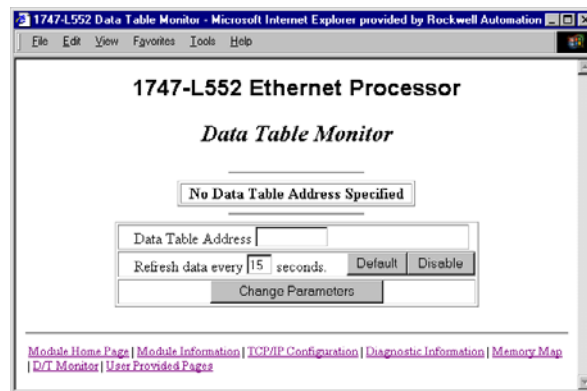

From here you may enter in the starting data table address to display.

## User Provided Pages

You can use a text editor to generate up to 16 user-provided web pages. Each page is stored in four consecutive ASCII files of the SLC 5/05 processor. The channel configuration feature of RSLogix 500 (version 6.0 or later) allows you to select the starting file number and the number of user pages to be stored, as shown in the following example.

**Figure 13.8 Channel Configuration Screen in RSLogix 500**

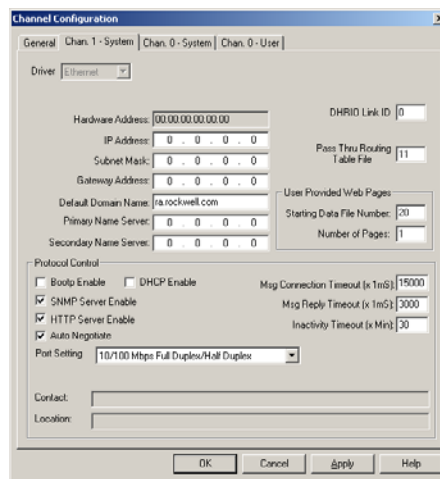

RSLogix 500 (version 6.0 or later) allows you to import an HTML file from your PC to specified ASCII files in the SLC 5/05 processor. See page 13-45 for details.

RSLogix 500 (version 6.3 or higher) allows you to export a page from the SLC 5/05 processor into an HTML source file on your PC. Refer to page 13-48 for more information.

## HTML Pages

**Referencing Other Pages/Servers** - following are some basic considerations when referencing other pages or servers.

- Reference User Specified Pages in the SLC 5/05 by using the names user1.html through user16.html
- To reference a page on the same processor, specify a URL such as /user2.html
- To reference a page on another processor, specify a URL such as http://www.xxx.yyy.zzz/user2.html, where www.xxx.yyy.zzz is the IP address of the processor
- You can reference other WWW servers and display images from other sources without affecting your usage of data table memory (except for the size of the HTTP reference)

**Referencing Data Table Memory** - reference data table memory locations by placing custom tags into your HTML source which specify the data table location and optional formatting information. Use the following format for the custom tag:

```
<!ABDTR-file_type{file_number};{file_element}[,#elements][%format]>
```

The items surrounded by {} are sometimes optional. The items surrounded by [] are always optional.

You must always specify the basic file reference. Depending on which file is being referenced, file\_number or file\_element may be defaulted. If the file\_type is I, O or S, the file\_number does not need to be specified, but the file\_element must be specified. If the file\_type is not one of the three special files, the file\_number must be specified and the file\_element may default to zero (the input, output and status files have fixed file numbers).

When defining your custom tag, consider the following:

**Table 13.12 Custom Tags:**

Tag Item	Description
#elements	If not specified, this defaults to one. If it is less than one, it also defaults to one. Each element is output using the same format (whether specified with %format or defaulted).
%format	Legal values are %d for decimal and %x for hexadecimal. The following file types allow the format to be specified. <ul style="list-style-type: none"> <li>• Input</li> <li>• Output</li> <li>• Status</li> <li>• Integer</li> <li>• Timer</li> <li>• Counter</li> <li>• Control</li> </ul>
Display format defaults	Input and Output file elements are output in decimal format. Status file elements are output in hexadecimal format with a leading 0x. Integer file elements are output in decimal format. Complex data types (Timer, Counter, Control) are output as a table with bits and important words specified.
Fixed display formats	Float files are always output in floating point format ("C"%g format). ASCII and SString files are always output as a null terminated text string. Binary files are always output as two binary bytes.

**HTML Examples** - the following example shows an HTML code segment with a short description of what you would see on a web browser

**Table 13.13 HTML Examples:**

Examples	HTML Code	Web Browser Displays
Input image word I:0	<!ABDTR-I:0>	the value of the first word of the input image table in the default format of decimal with bold type
Timer T4:0	<!ABDTR-T4:0>	the values of the timer in T4:0 in the default format of a table
Timer T4:0	<!ABDTR-T4:0%d>	the values of the three words comprising timer T4:0 in decimal with bold type
N24:0 to N24:3	<!ABDTR-N24:0,4>	the values of the four words in N24:0 through N24:3 in decimal with bold type
S:21 to S:23	<!ABDTR-S:21, 3%d>	the values of the three words in S:21 through S:23 in decimal with bold type

### Generating Custom Data Table Monitor Pages

You can generate Custom Data Table Monitor pages with your text editor then download them to the SLC 5/05 processor using RSLogix 500 version 6.0 or later. The first element of the file must contain a special tag as follows:

```
<!ABCDM-xx>
```

where **xx** is the automatic refresh rate in seconds (01-99).

A value outside the range defaults to a “snapshot” display. You can modify the refresh rate three different ways.

- Enter the desired refresh rate and press the *Change* button
- Select the *Default* button for a 15 second refresh
- Disable the refresh by selecting the *Disable* button

**Referencing Data Table Memory** - the Data Table locations in the Custom Data Table Monitor are referenced by placing custom tags into the ASCII file of the processor. The format of the custom tag is:

```
<!ABDTR-file_type{file_number}:{file_element}[,#elements][%format]
[#expand][!comment]>
```

The items surrounded with {} are sometimes optional, whereas the items surrounded by [] are always optional.

You must always specify the basic file reference. Depending on which file is being referenced, file\_number or file\_element may be defaulted. If the file\_type is I, O or S, the file\_number does not need to be specified, but the file\_element must be specified. If the file\_type is not one of the three special files, the file\_number must be specified and the file\_element may default to zero (because the input, output and status files have fixed numbers).

When defining your custom tag, consider the following:

**Table 13.14 Custom Tag Definition**

Tag Item	Description
#elements	If not specified, this defaults to one. If it is less than one, also defaults to one. Each element is output using the same format (whether specified with %format or defaulted). Any associated comment is displayed only for the first element.

Tag Item	Description
%format	<p>Legal values are %b for binary, %d for decimal, %O for octal and %x for hexadecimal. The following file types allow the format to be specified.</p> <ul style="list-style-type: none"> <li>• Input</li> <li>• Output</li> <li>• Status</li> <li>• Integer</li> </ul> <p>All other file types are displayed in an appropriate format. If a %format modifier is present, the format may be changed by clicking on the file type/number via a web browser.</p>
#expand	<p>Legal values are #c and #e. This modifier determines whether the structure file types are displayed in their expanded or compact formats. If a # modifier is present, the format may be changed by clicking on the [+] / [-] via a web browser. If a #modifier is not present, the default display of expanded is used.</p>
!comment	<p>Data after the exclamation point and up to the closing &gt; is displayed in the Comment column of the monitor.</p>
Fixed display formats	<p>Float files are always output in floating point format ("C"%g format). String files are always output as a null terminated text string. Binary files are always output as four binary nibbles. ASCII files are displayed in a memory dump format.</p>

### *Importing User Provided Page Files to the SLC 5/05 Processor*

Use RSLogix 500 to import user page files to the SLC 5/05 ASCII files:

1. In the Project folder (under the Data Files folder), right-click on the first of the block of four consecutive ASCII files where you will import the user page HTML file.
2. Click on Properties.
3. Click on Import HTML.
4. Use the browser to locate the user page HTML file you want to import.
5. Double-click on the file to select it.
6. Click OK.
7. Repeat this process for each desired user page file.
8. When all user page files have been imported, go online with your SLC 5/05 processor.
9. Select the User Provided Pages link to view the User Provided Pages menu, as shown in the following example.

**Figure 13.9 User Provided Pages Menu**

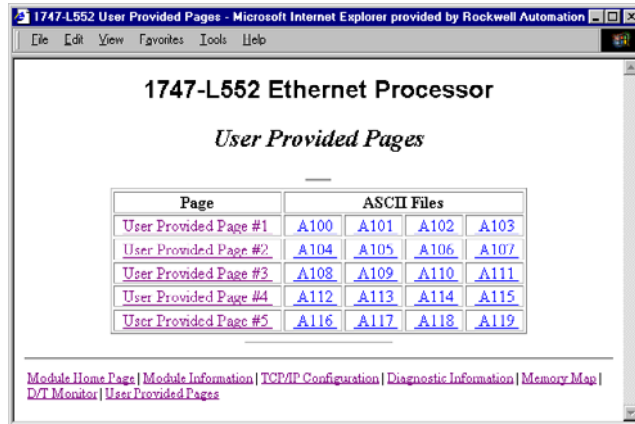

Click on the User Provided Page #X to display that specific page.

**Figure 13.10 User Provided Page #5 Displayed**

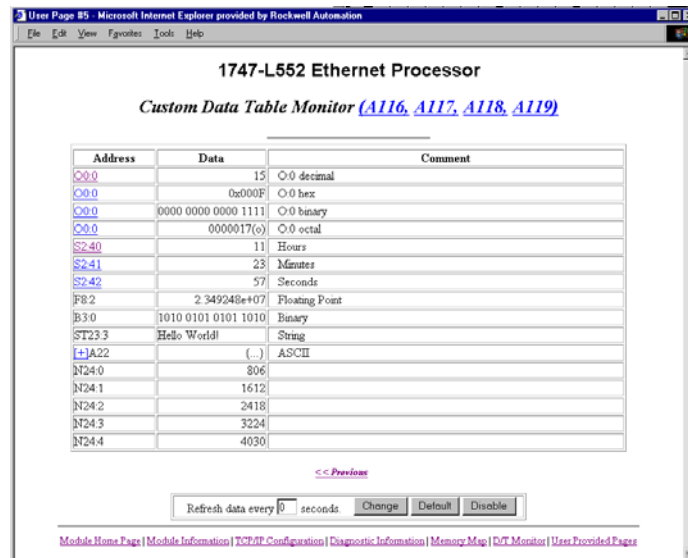

You can change the radix display of I, O, S, and N file addresses, which appear with an underline.

1. Go back to the User-Provided Custom Data Table Monitor page.





### *Exporting User Provided Page Files from the SLC 5/05 Processor*

To export user provided pages to HTML files:

1. In the Project folder (under the Data Files folder), right click on the first block of four consecutive ASCII files you want to export.
2. Click on Properties.
3. Click on Export HTML.
4. Name the file and browse to the subdirectory to save it in.
5. Click OK.
6. Repeat this process for each desired user page file.

## DF1 Full-duplex Communications

DF1 Full-duplex protocol (also referred to as DF1 point-to-point protocol) is provided for applications where RS-232 point-to-point communication is required. This type of protocol supports simultaneous transmissions between two devices in both directions. You can use channel 0 as a programming port, or as a peer-to-peer port using the MSG instruction.

In full-duplex mode, the SLC 5/03 (or higher) processor can send and receive messages. When the processor receives messages, it acts as an end device - a device that stops the transmission of data packets. The processor ignores the destination and source addresses received in the data packets. However, the processor exchanges these addresses in the reply that it transmits in response to any command data packet that it has received.

If you use a modem with DF1 channel 0 in the full-duplex mode, it must be capable of operating in full-duplex mode. Typically, a dial-up modem is used for communication over telephone lines.

### Configuring Channel 0 for DF1 Full-duplex

To configure an SLC 5/03, SLC 5/04 or SLC 5/05 processor channel 0 for DF1 full-duplex, do the following using your programming software.

To bring up the Channel Configuration interface, double-click on the Channel Configuration icon.

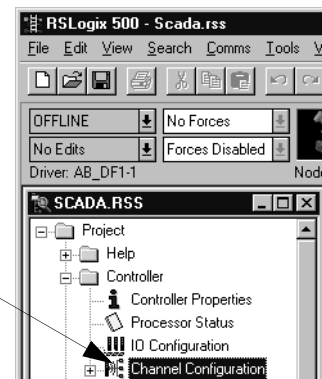

Define the location of the diagnostic file used for Channel Status here. For channel status details, refer to 13-53.

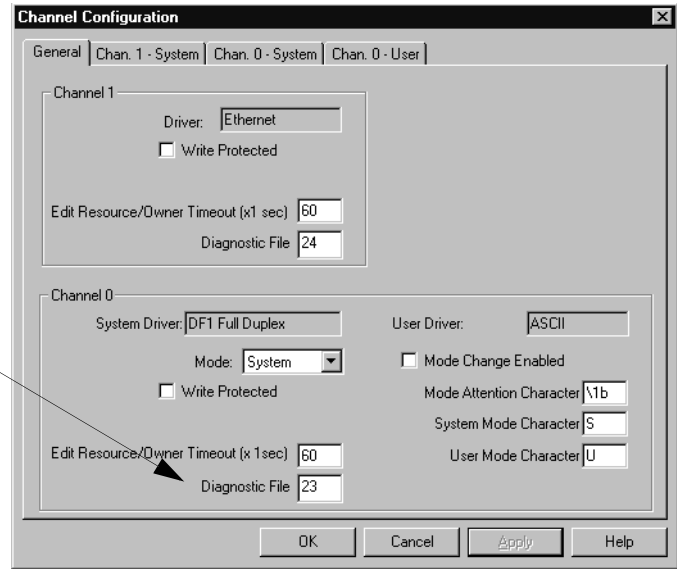

1. On the Channel 0 tab, choose DF1 Full-Duplex for your Driver.
2. Configure the communication driver characteristics according to table 13.15.

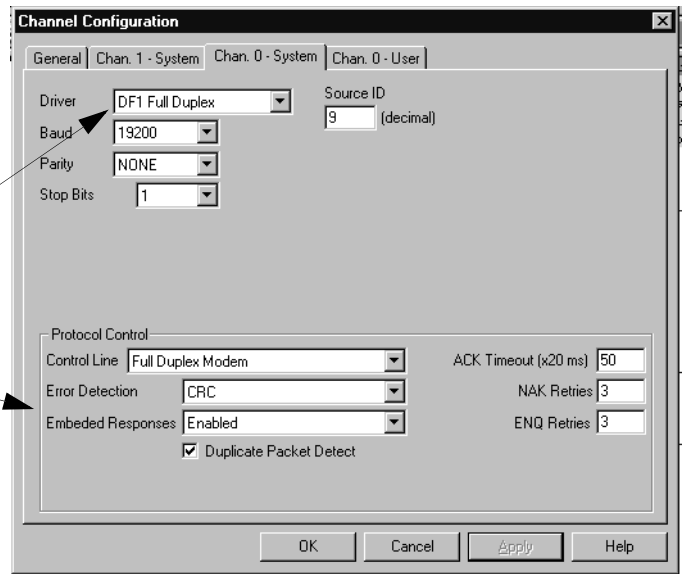

**Table 13.15 Define these communication parameters when configuring a SLC 5/03, 5/04, or 5/05 processor for DF1 full-duplex communication.**

Tab	Parameter	Default	Selections
General	Diagnostic File	0	SLC 5/03 (OS 302, Series C or higher), SLC 5/04 (OS 401, Series C or higher) and SLC 5/05 only. Select an unused file (9 to 255) to store channel status information. You must define a diagnostic file in order to be able to view channel 0 status. See Table 13.25 on page 13-82 for a file description.
Channel 0 System	Baud Rate	19,200	Select a communication rate that all devices in your system support. Configure all devices in the system for the same communication rate.
	Parity	None	Parity provides additional message packet error detection. To implement even parity checking, choose Even. To implement no parity checking, choose None.
	Stop Bits	1	Match the number of stop bits to the devices with which you are communicating.
	Source ID	9	This is the address, in decimal, that is used as the source address in any message initiated by this processor. When DF1 passthru is enabled (S:34/5 is set), configure the source ID to equal the channel 1 DH+ address in an SLC 5/04, or zero in an SLC 5/05 processor.
	Control Line	No Handshaking	This parameter defines the mode in which the driver operates. Choose a method appropriate for your system's configuration. <ul style="list-style-type: none"> <li>• If you are not using a modem, choose NO HANDSHAKING.</li> <li>• If you are using full-duplex modems, choose FULL-DUPLEX MODEM.</li> </ul> See page 13-86 for descriptions of the control line operation settings

**Table 13.15 Define these communication parameters when configuring a SLC 5/03, 5/04, or 5/05 processor for DF1 full-duplex communication. (Continued)**

<b>Tab</b>	<b>Parameter</b>	<b>Default</b>	<b>Selections</b>
Channel 0 System	Error Detection	CRC	<p>With this selection, you choose the how the processor checks the accuracy of each DF1 packet transmission.</p> <p>BCC: This algorithm provides a medium level of data security. It cannot detect:</p> <ul style="list-style-type: none"> <li>• transposition of bytes during transmission of a packet.</li> <li>• the insertion or deletion of data values of zero within a packet.</li> </ul> <p>CRC: This algorithm provides a higher level of data security. Select an error detection method that all devices in your configuration can use.</p> <p>When possible, choose CRC.</p>
	Embedded Responses	Auto-detect	<p>To use embedded responses, choose Enabled. If you want the processor to use embedded responses only when it detects embedded responses from another device, choose Auto-detect. If you are communicating with another Allen-Bradley device, choose Enabled. Embedded responses increase network traffic efficiency.</p>
	Duplicate Packet Detect	Enabled	<p>Duplicate Detect lets the SLC detect if it has received a message that is a duplicate of its most recent message from the master station. If you choose duplicate detect, the processor will acknowledge (ACK) the message but will not act on it since it has already performed the message's task when it received the command from the first message.</p> <p>If you want to detect duplicate packets and discard them, check this parameter. If you want to accept duplicate packets and execute them, leave this parameter unchecked.</p>
	ACK Timeout	50	<p>The amount of time in 20 millisecond increments that you want the processor to wait for an acknowledgment to the message it has sent before sending an enquiry (ENQ) for the reply.</p>
	NAK Retries	3	<p>The number of times the processor will resend a message packet because the processor received a NAK response to the previous message packet transmission.</p>
	ENQ Retries	3	<p>The number of enquiries (ENQs) that you want the processor to send after an ACK timeout occurs.</p>

## DF1 Full-duplex Channel Status

Channel Status data is stored in the diagnostic file defined on the Channel 0 Configuration screen. See Table 13.25 for information regarding the diagnostic counter data displayed.

Double-click on the Channel Status icon located beneath the Configuration icon to bring up the Channel Status screen.

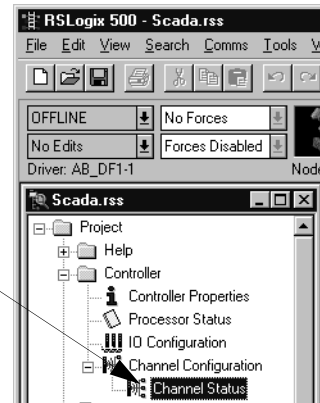

See the following table for details concerning the DF1 Full-duplex Channel Status Screen.

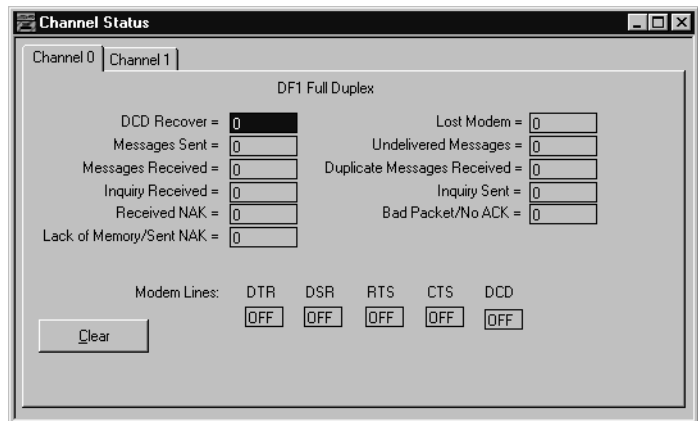

**Table 13.16 SLC 5/03 and Higher Channel 0 DF1 Full-duplex Channel Status**

Status Field	Diagnostic File Location	Definition
DCD Recover	word 11	The number of times the processor detects the DCD handshaking line has gone low to high
Messages Sent	word 1	The total number of DF1 messages sent by the processor (including message retries)
Messages Received	word 2	The number of messages received with no errors
Inquiry Received	word 6	The number of ENQs received by the processor
Received NAK	word 5	The number of NAKs received by the processor
Lack of Memory/Sent NAK	word 8	The number of times the processor could not receive a message because it did not have available memory
Lost Modem	word 12	The number of times the lost modem bit has gone low to high
Undelivered Messages	word 3	The number of messages that were sent by the processor but not acknowledged by the destination device
Duplicate Messages Received	word 9	The number of times the processor received a message packet identical to the previous message packet
Inquiry Sent	word 4	The number of ENQs sent by the processor
Bad Packet/No ACK	word 7	The number of incorrect data packets received by the processor for which a NAK was returned
DTR (Data Terminal Ready)	word 0;bit 4	The status of the DTR handshaking line (asserted by the processor)
DSR (Data Set Ready)	word 0;bit 2	The status of the DSR handshaking line (received by the processor)
RTS (Request to Send)	word 0;bit 1	The status of the RTS handshaking line (asserted by the processor)
CTS (Clear to Send)	word 0;bit 0	The status of the CTS handshaking line (received by the processor)
DCD (Data Carrier Detect)	word 0;bit 3	The status of the DCD handshaking line (received by the processor)

For processors running OS Series C, FRN 6 and higher, clicking the Clear button while monitoring Channel Status of either channel 1 or channel 0 online, will reset all of the channel status diagnostic counters for both channels to zero. Prior to OS Series C, FRN 6 the only channel status diagnostic counters that are reset when the Clear button is clicked are the ones on the channel that the programming terminal is connected to. For example, if your programming terminal is connected online via channel 0 and you are monitoring the Channel Status of channel 1, when you click on the Clear button, only channel 0 diagnostic counters will be reset, not channel 1 diagnostic counters.



## **DF1 Half-duplex Communications**

DF1 Half-duplex Master/Slave protocol provides a multi-drop single master/multiple slave network. In contrast to DF1 full-duplex, communication takes place in one direction at a time.

The master device initiates all communication by “polling” each slave device. The slave device may only transmit data packets when it is polled by the master. It is the master’s responsibility to poll each slave on a regular and sequential basis to collect data. During a polling sequence, the master polls a slave repeatedly until the slave indicates that it has no more data packets to transmit. The master then transmits the data packets for that slave.

Many Allen-Bradley products support half-duplex master protocol. They include the enhanced PLC-5 processors, SLC 5/03 (OS301 and higher), SLC 5/04, and SLC 5/05 processors. RSLinx (V2.0 and higher) software also supports DF1 half-duplex master protocol.

Typically, the master keeps two separate tables - one for online slaves and one for offline slaves. The online slaves are polled on a regular basis. The offline slaves are polled occasionally to see if they have come back online.

A master device supports routing of data packets from one slave to another.

DF1 half-duplex supports up to 255 slave devices (address 0 to 254) with address 255 reserved for master broadcasts. Either half-duplex or full-duplex modem types can be used for DF1 half-duplex network. All SLC 5/03, SLC 5/04, and SLC 5/05 processors support broadcast reception, but only processors running OS Series C, FRN 6 or higher can initiate broadcast write commands.

### **DF1 Half-duplex Master Broadcast**

A broadcast write command initiated by the DF1 half-duplex master is received and executed by all DF1 half-duplex slaves. A broadcast write command received by the DF1 half-duplex master after polling a DF1 half-duplex slave is received, acknowledged and re-broadcast without being executed by the DF1 half-duplex master. It is treated like any other slave-to-slave command, except that no acknowledgement is expected after the re-broadcast.

### **DF1 Half-duplex Slave Broadcast**

When a broadcast write command is initiated by a DF1 half-duplex slave, it is queued up just like any other MSG command until it receives a poll from the DF1 half-duplex master. After transmitting the broadcast write command, the DF1 half-duplex slave receives an acknowledgement that the DF1 half-duplex

master received the packet without error. When the DF1 half-duplex master re-broadcasts the broadcast write command, the initiating DF1 half-duplex slave receives and executes the command along with all of the other slave nodes receiving the broadcast packet. No acknowledgement or reply is returned.

## Configuring Channel 0 for Standard Polling Mode DF1 Half-duplex Master

Choose DF1 half-duplex master in standard polling mode if you want to query slave stations for information based upon user-configured polling ranges. This mode is used most often in point-to-multipoint configurations.

To configure the processor for a master station using standard polling mode, place the processor into program mode and do the following using your programming software:

To bring up the Channel Configuration interface, double-click on the Channel Configuration icon.



Define the location of the diagnostic file used for Channel Status here. For Channel Status details, see page 13-68.

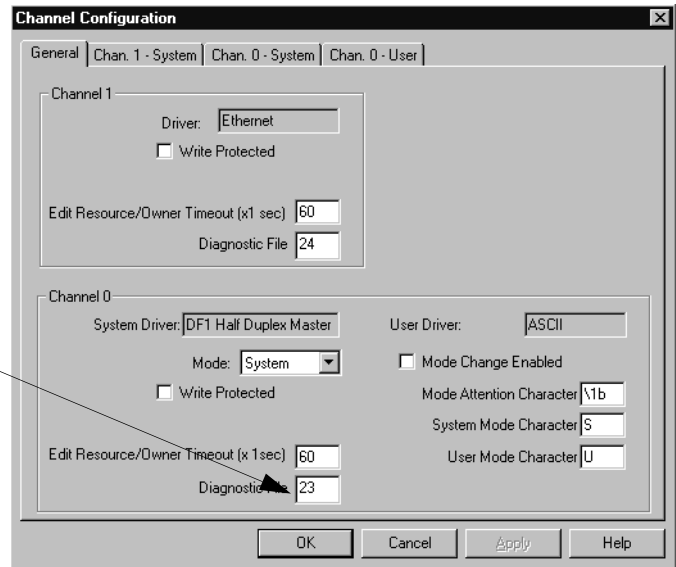

1. On the Channel 0 tab, choose DF1 Half-Duplex for your Driver.
2. Choose a Standard Polling Mode.
3. Configure the rest of the communication driver characteristics according to Table 13.16.

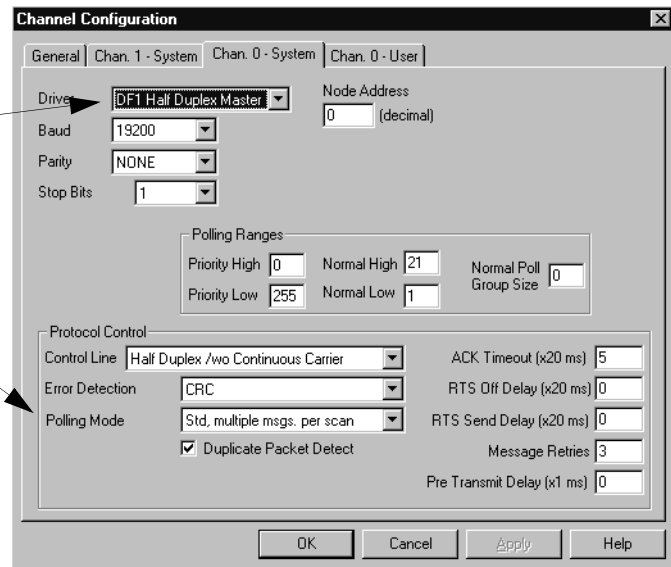

**Table 13.17 Define these parameters when configuring a SLC 5/03, 5/04, or 5/05 processor as a master station using standard polling mode to communicate with slave stations**

Tab	Parameter	Default	Selections
General	Diagnostic File	0	SLC 5/03 (OS 302, Series C or higher), SLC 5/04 (OS 401, Series C or higher) and SLC 5/05 only. Select an unused file (9 to 255) to store channel status information. You must define a diagnostic file in order to be able to view channel 0 status. See Table 13.21 on page 13-68 for a file description.
Channel 0 System	Baud Rate	1200	Select a communication rate that all devices in your system support. Configure all devices in the system for the same communication rate.
	Parity	None	Parity provides additional message packet error detection. To implement even parity checking, choose Even. To implement no parity checking, choose None.
	Stop Bits	1	Match the number of stop bits to the device with which you are communicating.
	Node Address	0	A node address identifies the processor on the DF1 half-duplex link. Each station on a link must have a unique address. Choose an address between $0_{10}$ and $254_{10}$ . Node address $255_{10}$ is the broadcast address, and cannot be selected as a station's individual address
	Control Line	No Handshaking	This parameter defines the mode in which the driver operates. Choose a method appropriate for your system's configuration. <ul style="list-style-type: none"> <li>• If you are not using a modem, choose NO HANDSHAKING.</li> <li>• If the master modem is full duplex, choose FULL-DUPLEX MODEM.</li> <li>• If all the modems in the system are half-duplex, choose HALF-DUPLEX WITHOUT CONTINUOUS CARRIER.</li> </ul>
	Error Detection	CRC	With this selection, you choose the how the processor checks the accuracy of each DF1 packet transmission. <p>BCC: This algorithm provides a medium level of data security. It cannot detect:</p> <ul style="list-style-type: none"> <li>• transposition of bytes during transmission of a packet.</li> <li>• the insertion or deletion of data values of zero within a packet.</li> </ul> <p>CRC: This algorithm provides a higher level of data security.</p> <p>Select an error detection method that all devices in your configuration can use.</p> <p>When possible, choose CRC.</p>

**Table 13.17 Define these parameters when configuring a SLC 5/03, 5/04, or 5/05 processor as a master station using standard polling mode to communicate with slave stations (Continued)**

Tab	Parameter	Default	Selections
	Polling Mode	Message Based	<p>If you want to receive:</p> <ul style="list-style-type: none"> <li>only one message from a slave station per its turn, choose STANDARD (SINGLE MESSAGE TRANSFER PER NODE SCAN). Choose this method only if it is critical to keep the poll list scan time to a minimum.</li> <li>as many messages from a slave station as it has, choose STANDARD (MULTIPLE MESSAGE TRANSFER PER NODE SCAN).</li> </ul>
	Duplicate Packet Detect	Checked	<p>Duplicate Detect lets the SLC detect if it has received a message that is a duplicate of its most recent message from another station. If you choose duplicate detect, the processor will acknowledge (ACK) the message but will not act on it since it has already performed the message's task when it received the command from the first message.</p> <p>If you want to detect duplicate packets and discard them, leave this parameter checked. If you want to accept duplicate packets and execute them, uncheck this parameter.</p>
	ACK Timeout	50	The amount of time in 20 millisecond increments that you want the processor to wait for an acknowledgment to the message it has sent before the processor retries the message or the message errors out. This timeout value is also used for the poll response timeout.
	RTS Off Delay	0	Defines the amount of time in 20 millisecond increments that elapses between the end of the message transmission and the de-assertion of the RTS signal. This time delay is a buffer to make sure that the modem has transmitted the message but should normally be left at zero.
	RTS Send Delay	0	Defines the amount of time in 20 millisecond increments that elapses between the assertion of the RTS signal and the beginning of the message transmission. This time allows the modem to prepare to transmit the message. The Clear-to-Send (CTS) signal must be high for transmission to occur.
	Pre-Transmit Delay	0	Defines the amount of time in 1 millisecond increments that elapses between when the processor has a message to send and when it either asserts the RTS signal (if handshaking is selected) or begins transmitting (if no handshaking is selected).
	Message Retries	3	<p>Defines the number of times a master station retries either:</p> <ul style="list-style-type: none"> <li>a message before it declares the message undeliverable.</li> <li>or a poll packet to an active station before the master station declares that station to be inactive.</li> </ul> <p>A poll packet is transmitted prior to each message retry.</p>
	Priority Polling Range – High	0	Select the last slave station address to priority poll.
	Priority Polling Range – Low	255	Select the first slave station address to priority poll. Entering 255 disables priority polling.

**Table 13.17 Define these parameters when configuring a SLC 5/03, 5/04, or 5/05 processor as a master station using standard polling mode to communicate with slave stations (Continued)**

<b>Tab</b>	<b>Parameter</b>	<b>Default</b>	<b>Selections</b>
	Normal Polling Range – High	0	Select the last slave station address to normal poll.
	Normal Polling Range – Low	255	Select the first slave station address to normal poll. Entering 255 disables normal polling.
	Normal Poll Group Size	0	Enter the quantity of active stations located in the normal poll range that you want polled during a scan through the normal poll range before returning to the priority poll range. If no stations are configured in the Priority Polling Range, leave this parameter at 0.

## Minimum DF1 Half-duplex Master Channel 0 ACK Timeout

The governing timeout parameter to configure for a DF1 Half-duplex Master is the channel 0 ACK Timeout. The ACK Timeout is the amount of time you want the processor to wait for an acknowledgment of its message transmissions. Set in 20 millisecond intervals, the value is the amount of time the master will wait for:

- an ACK to be returned by a slave when the master has just sent it a message, or
- a poll response or message to be returned by a slave when the master has just sent it a poll packet.

The timeout must be long enough that after the master has transmitted the last character of the poll packet, there is enough time for a slave to transmit (and the master receive) a maximum sized packet before the time expires.

To calculate the minimum ACK timeout, you must know:

- the modem baud rate.
- maximum sized data packet (the maximum number of data words that a slave write command or read reply packet might contain).
- the RTS/CTS or turnaround delay of the slave modem.
- the configured RTS Send Delay in the slave.
- the program scan time of the slave.

## Determining Minimum Master ACK Timeout

To determine the minimum ACK Timeout, you must first calculate the transmission time by multiplying the maximum sized data packet for your processor by the modem rate in ms/byte. For an example we will assume an SLC 5/03 processor (103 data words or 224 bytes total packet size including overhead) and a 9600 bps modem, which transmits at approximately 1 ms/byte. Therefore, the message transmission time is 224 ms. For approximate modem transmission rates, see the following table.

**Table 13.18 Approximate modem transmission rates**

modem bps	approx. ms/byte
4800	2 ms/byte
9600	1 ms/byte
19200	.5 ms/byte

Next, you need to determine the average slave program scan time. In RSLogix 500, double click on the Processor Status icon and then locate Average on the Scan Times tab. For this example, let's assume an average slave program scan time of 20 ms. Remember, program scan time will vary by application.

Finally, you must determine the larger of two values, either the configured slave RTS Send Delay or the turnaround time of the slave modem. The RTS Send Delay time can be found by double-clicking on the slave's Channel Configuration icon and looking at the Chan. 0 System tab of the Channel Configuration screen. Note that the RTS Send Delay time is in intervals of 20 ms, so with a value of 3 in the box, the RTS Send Delay time would be 20 ms multiplied by 3. Using this value (60 ms) for our example, and assuming that the turnaround time of the modem is 50 ms (which will vary by modem) you would choose to use the RTS Send Delay time of 60 ms for your calculation.

Having determined the maximum message transmission time (224 ms), the average slave program scan time (20 ms) and the largest of either RTS Send Delay (60 ms) or the modem turnaround time, the minimum ACK timeout is simply the sum of these values.

**Table 13.19 Sum of the Transmission Rates**

Parameter	Example Values (in ms)
Max message transmission time	224
Average program scan time	20
RTS Send Delay	60

Use only the largest of these two values



**Table 13.19 Sum of the Transmission Rates**

Parameter	Example Values (in ms)
modem turnaround time	50
calculated ACK Timeout	304
round up to nearest 20 ms	320

## Monitor Active Stations

To see what stations are active, view the channel 0 active node table in the SLC 5/03, SLC 5/04, or SLC 5/05 processor status file (S:67/0-S:82/15). Each bit in the file represents a station on the link. The stations are numbered in order as a continuous bitstream file starting with the first bit in word S:67 (See Figure 13.12 below).

**Figure 13.12 Example Active Node Table**

Channel 0 Active Node Table (S67 - S83):	
Node 0	16
0	0000-0000-0000-0000 0000-0000-0000-0000
32	0000-0000-0000-0000 0000-0000-0000-0000
64	0000-0000-0000-0000 0000-0000-0000-0000
96	0000-0000-0000-0000 0000-0000-0000-0000
128	0000-0000-0000-0000 0000-0000-0000-0000
160	0000-0000-0000-0000 0000-0000-0000-0000
192	0000-0000-0000-0000 0000-0000-0000-0000
224	0000-0000-0000-0000 0000-0000-0000-0000

At powerup or after reconfiguration, the master station assumes that all slave stations are inactive. A station is shown active only after it responds to a poll packet.

## Configuring Channel 0 for Message-based Polling Mode DF1 Half-duplex Master

Choose DF1 half-duplex master in message-based polling mode if you want to use MSG instructions in user programming to communicate with one station at a time. If your application uses satellite transmission or public switched telephone network transmission, consider choosing message-based.

Communication to a slave station can be initiated on an as-needed basis.

Message-based communication should also be used in redundant SLC master station systems implemented with the 1746-BSN backup communication module.

With message-based mode, you do not have an active node file that you can use to monitor station status. Also, you cannot implement slave station-to-slave station messaging.

To configure the processor for a master station using message-based polling mode, place the processor in program mode and do the following using your programming software.

To bring up the Channel Configuration interface, double-click on the Channel Configuration icon.

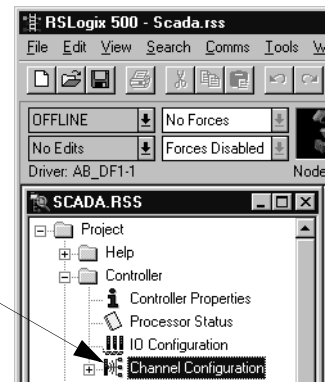

Define the location of the diagnostic file used for Channel Status here. For Channel Status details, see page 13-68.

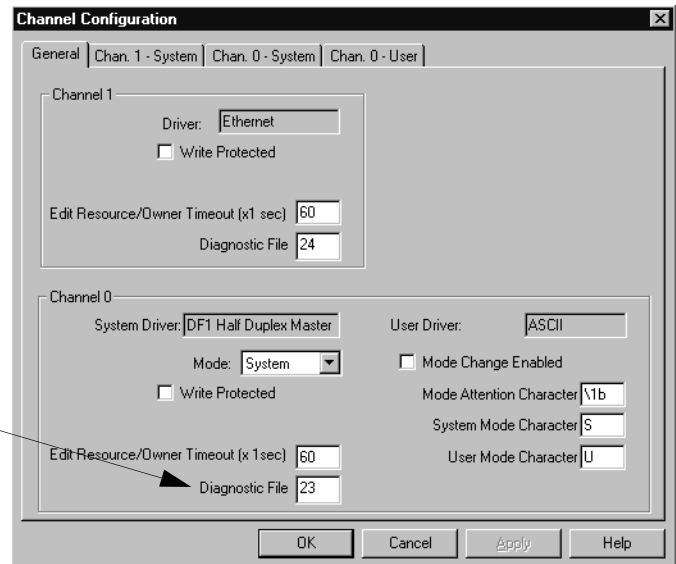

1. On the Channel 0 tab, choose DF1 Half-Duplex Master for your Driver.
2. Choose a Message-based Polling Mode.
3. Configure the communication driver characteristics according to Table 13.20.

The image shows a 'Channel Configuration' dialog box with four tabs: 'General', 'Chan. 1 - System', 'Chan. 0 - System', and 'Chan. 0 - User'. The 'Chan. 0 - User' tab is selected. The 'Driver' dropdown is set to 'DF1 Half Duplex Master'. The 'Node Address' is '1 (decimal)'. The 'Baud' rate is '19200', 'Parity' is 'NONE', and 'Stop Bits' is '1'. Under 'Protocol Control', 'Control Line' is 'Half Duplex /wo Continuous Carrier', 'Error Detection' is 'CRC', 'Polling Mode' is 'Msg. Allow Slaves to Initiate', and 'Duplicate Packet Detect' is checked. Numerical values for 'ACK Timeout (x20 ms)', 'RTS Off Delay (x20 ms)', 'RTS Send Delay (x20 ms)', 'Message Retries', 'Reply Msg. Timeout (x20 ms)', and 'Pre Transmit Delay (x1 ms)' are all set to 0, 0, 0, 3, 0, and 0 respectively. Buttons for 'OK', 'Cancel', 'Apply', and 'Help' are at the bottom.

Parameter	Value
Driver	DF1 Half Duplex Master
Node Address	1 (decimal)
Baud	19200
Parity	NONE
Stop Bits	1
Control Line	Half Duplex /wo Continuous Carrier
Error Detection	CRC
Polling Mode	Msg. Allow Slaves to Initiate
Duplicate Packet Detect	<input checked="" type="checkbox"/>
ACK Timeout (x20 ms)	50
RTS Off Delay (x20 ms)	0
RTS Send Delay (x20 ms)	0
Message Retries	3
Reply Msg. Timeout (x20 ms)	0
Pre Transmit Delay (x1 ms)	0

**Table 13.20 Define these parameters when configuring a SLC 5/03, 5/04, or 5/05 processor as a master station using message-based polling mode to communicate with slave stations.**

Tab	Parameter	Default	Selections
General	Diagnostic File	0	SLC 5/03 (OS 302, Series C or higher), SLC 5/04 (OS 401, Series C or higher) and SLC 5/05 only. Select an unused file (9-255) to store channel status information. You must define a diagnostic file in order to be able to view channel 0 status. See Table 13.21 on page 13-68 for a file description.
Channel 0 System	Baud Rate	1200	Select a communication rate that all devices in your system support. Configure all devices in the system for the same communication rate.
	Parity	None	Parity provides additional message packet error detection. To implement even parity checking, choose Even. To implement no parity checking, choose None.
	Stop Bits	1	Match the number of stop bits to the devices with which you are communicating.
	Node Address	0	A node address identifies the processor on the DF1 half-duplex link. Each station on a link must have a unique address. Choose an address between $0_{10}$ and $254_{10}$ . Node address $255_{10}$ is the broadcast address, and cannot be selected as a station's individual address
	Control Line	No Handshaking	<p>This parameter defines the mode in which the driver operates. Choose a method appropriate for your system's configuration.</p> <ul style="list-style-type: none"> <li>• If you are not using a modem, choose NO HANDSHAKING.</li> <li>• If the master modem is full duplex, choose FULL-DUPLEX.</li> <li>• If all the modems in the system are half-duplex, choose HALF-DUPLEX WITHOUT CONTINUOUS CARRIER.</li> </ul> <p>See page 13-86 for descriptions of control line operation settings.</p>
Error Detection	CRC	<p>With this selection, you choose the how the processor checks the accuracy of each DF1 packet transmission.</p> <p>BCC: This algorithm provides a medium level of data security. It cannot detect:</p> <ul style="list-style-type: none"> <li>• transposition of bytes during transmission of a packet.</li> <li>• the insertion or deletion of data values of zero within a packet.</li> </ul> <p>CRC: This algorithm provides a higher level of data security.</p> <p>Select an error detection method that all devices in your configuration can use.</p> <p>When possible, choose CRC.</p>	

**Table 13.20 Define these parameters when configuring a SLC 5/03, 5/04, or 5/05 processor as a master station using message-based polling mode to communicate with slave stations. (Continued)**

Tab	Parameter	Default	Selections
Channel 0 System	Polling Mode	Message Based	<p>If you want to accept unsolicited messages from slave stations, choose MESSAGE BASED (ALLOW SLAVES TO INITIATE MESSAGES)</p> <p>Slave station-initiated messages are acknowledged and processed after all master station-initiated (solicited) messages.</p> <p><b>Note:</b> Slave stations can only send messages when they are polled. If the message-based master station never sends a slave station a message, the master station will never send the slave station a poll. Therefore, to regularly obtain a slave station-initiated message from a slave station, you should choose to use standard communication mode instead.</p> <p>Ignore unsolicited messages from slave stations, choose MESSAGE BASED (DO NOT ALLOW SLAVES TO INITIATE MESSAGES)</p> <p>Slave station-initiated messages are acknowledged and discarded. The master station acknowledges the slave station-initiated message so that the slave station removes the message from its transmit queue, which allows the next packet slated for transmission into the transmit queue.</p>
	Duplicate Packet Detect	Checked	<p>Duplicate Detect lets the SLC detect if it has received a message that is a duplicate of its most recent message from another station. If you choose duplicate detect, the processor will acknowledge (ACK) the message but will not act on it since it has already performed the message's task when it received the command from the first message.</p> <p>If you want to detect duplicate packets and discard them, leave this parameter checked. If you want to accept duplicate packets and execute them, uncheck this parameter.</p>
	Reply Message Wait Time	1	<p>Define the amount of time in 20 millisecond increments that the master station will wait after receiving an ACK (to a master-initiated message) before polling the slave station for a reply.</p> <p>Choose a time that is, at minimum, equal to the longest time that a slave station needs to format a reply packet. This would typically be the maximum scan time of the slave station.</p>
	ACK Timeout	50	The amount of time in 20 millisecond increments that you want the processor to wait for an acknowledgment to the message it has sent before the processor retries the message or the message errors out. This timeout value is also used for the poll response timeout.
	RTS Off Delay	0	Defines the amount of time in 20 millisecond increments that elapses between the end of the message transmission and the de-assertion of the RTS signal. This time delay is a buffer to make sure that the modem has transmitted the message but should normally be left at zero. See page 13-89 for further guidelines for setting this parameter.
	RTS Send Delay	0	Defines the amount of time in 20 millisecond increments that elapses between the assertion of the RTS signal and the beginning of the message transmission. This time allows the modem to prepare to transmit the message. The Clear-to-Send (CTS) signal must be high for transmission to occur.
	Pre-Transmit Delay	0	Defines the amount of time in 1 millisecond increments that elapses between when the processor has a message to send and when it asserts the RTS signal (if handshaking is selected) or begins transmitting (if no handshaking is selected).
	Message Retries	3	Defines the number of times a master station retries a message before it declares the message undeliverable. A poll packet is transmitted prior to each message retry.

## DF1 Half-duplex Master Channel Status

Channel Status data is stored in the diagnostic file defined on the Channel 0 Configuration screen. See Table 13.21 on page 13-68 for information regarding the diagnostic counter data displayed.

Double-click on the Channel Status icon located beneath the Configuration icon to bring up the Channel Status screen.



See Table 13.21 for details concerning the DF1 Half-Duplex Master Channel Status Screen.

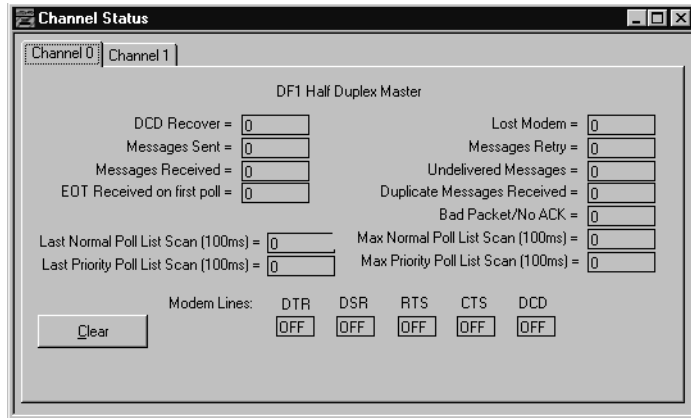

**Table 13.21 SLC 5/03 and Higher Channel 0 DF1 Half-duplex Master Channel Status**

Status Field	Diagnostic File Location	Definition
DCD Recover	word 11	The number of times the processor detects the DCD handshaking line has gone low to high
Messages Sent	word 1	The total number of DF1 messages sent by the processor (including message retries)
Messages Received	word 2	The number of messages received with no errors
EOT Received on First Poll	word 8	Not implemented
Last Normal Poll List Scan	word 5	Time in 100 ms increments of last scan through Normal Poll List
Last Priority Poll List Scan	word 10	Time in 100 ms increments of last scan through Priority Poll List
Lost Modem	word 12	The number of times the lost modem bit has gone low to high

**Table 13.21 SLC 5/03 and Higher Channel 0 DF1 Half-duplex Master Channel Status (Continued)**

Status Field	Diagnostic File Location	Definition
Message Retry	word 4	The number of message retries sent by the processor
Undelivered Messages	word 3	The number of messages that were sent by the processor but not acknowledged by the destination device
Duplicate Messages Received	word 9	The number of times the processor received a message packet identical to the previous message packet
Bad Packet/No ACK	word 7	The number of incorrect data packets received by the processor for which no ACK was returned
Max Normal Poll List Scan	word 6	Maximum time in 100 ms increments to scan the Normal Poll List
Max Priority Poll List Scan	word 13	Maximum time in 100 ms increments to scan the Priority Poll List
DTR (Data Terminal Ready)	word 0;bit 4	The status of the DTR handshaking line (asserted by the processor)
DSR (Data Set Ready)	word 0;bit 2	The status of the DSR handshaking line (received by the processor)
RTS (Request to Send)	word 0;bit 1	The status of the RTS handshaking line (asserted by the processor)
CTS (Clear to Send)	word 0;bit 0	The status of the CTS handshaking line (received by the processor)
DCD (Data Carrier Detect)	word 0;bit 3	The status of the DCD handshaking line (received by the processor)

For processors running OS Series C, FRN 6 and higher, clicking the Clear button while monitoring Channel Status of either channel 1 or channel 0 online, will reset all of the channel status diagnostic counters for both channels to zero. Prior to OS Series C, FRN 6 the only channel status diagnostic counters that are reset when the Clear button is clicked are the ones on the channel that the programming terminal is connected to. For example, if your programming terminal is connected online via channel 0 and you are monitoring the Channel Status of channel 1, when you click on the Clear button, only channel 0 diagnostic counters will be reset, not channel 1 diagnostic counters.

## Configuring Channel 0 for DF1 Half-duplex Slave

To configure an SLC 5/03, SLC 5/04 or SLC 5/05 processor channel 0 for DF1 half-duplex slave, do the following using your programming software:

To bring up the Channel Configuration interface, double-click on the Channel Configuration icon.

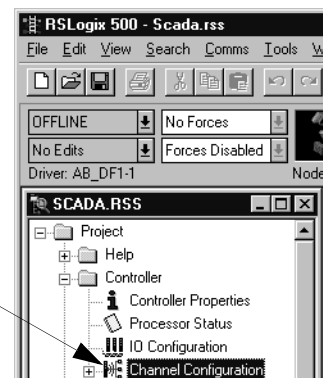

Define the location of the diagnostic file used for Channel Status here. For Channel Status details, see page 13-74.

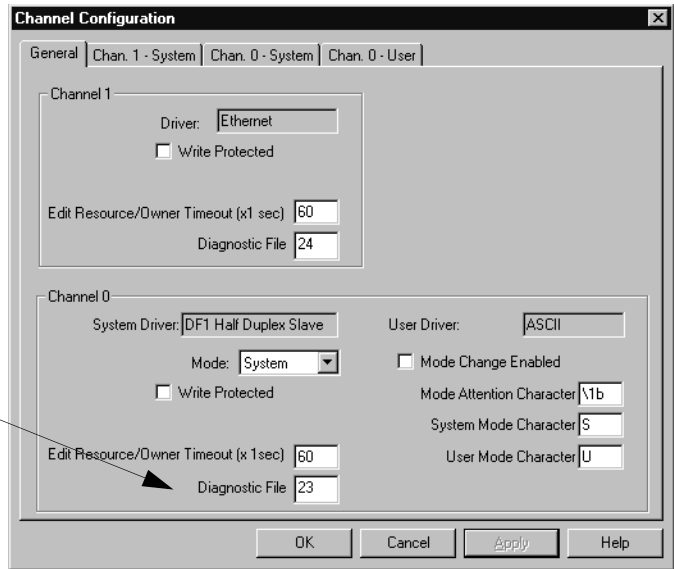

1. On the Channel 0 tab, choose DF1 Half-Duplex Slave for your Driver.
2. Configure the communication driver characteristics according to Table 13.22.

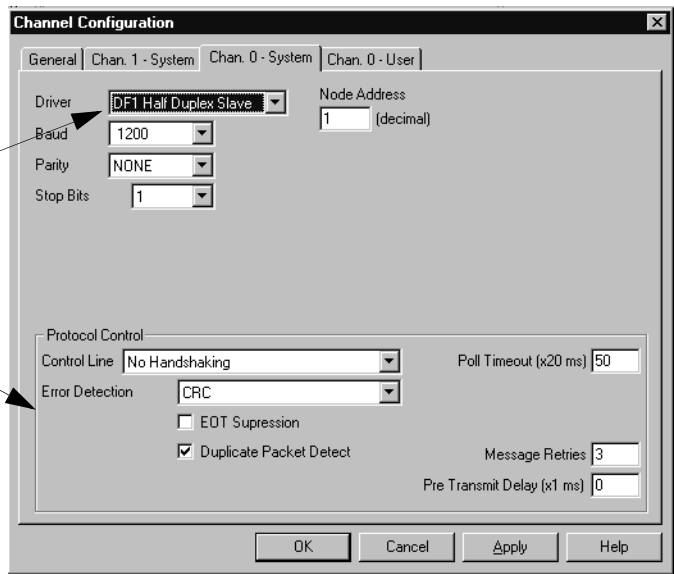



**Table 13.22 Define these parameters when configuring a SLC 5/03, 5/04, or 5/05 processor as a slave station.**

Tab	Parameter	Default	Selections
General	Diagnostic File	0	SLC 5/03 (OS 302, Series C or higher), SLC 5/04 (OS 401, Series C or higher) and SLC 5/05 only. Select an unused file (9 to 255) to store channel status information. You must define a diagnostic file in order to be able to view channel 0 status. See Table 13.23 on page 13-74 for a file description.
Chan. 0 System	Baud Rate	1200	Select a communication rate that all devices in your system support. Configure all devices in the system for the same communication rate.
	Parity	None	Parity provides additional message packet error detection. To implement even parity checking, choose Even. To implement no parity checking, choose None.
	Stop Bits	1	Match the number of stop bits to the device with which you are communicating.
	Node Address	0	A node address identifies the processor on the DF1 half-duplex link. Each station on a link must have a unique node address. Choose an address between $0_{10}$ and $254_{10}$ . Node address $255_{10}$ is the broadcast address, which you cannot select as a station's individual address.
	Control Line	No Handshaking	<p>This parameter defines the mode in which the driver operates. Choose a method appropriate for your system's configuration.</p> <ul style="list-style-type: none"> <li>• If you are not using a modem, choose NO HANDSHAKING.</li> <li>• If the master modem is full duplex and the slave modem is half-duplex, choose HALF-DUPLEX WITH CONTINUOUS CARRIER.</li> <li>• If all the modems in the system are half-duplex, choose HALF-DUPLEX WITHOUT CONTINUOUS CARRIER.</li> </ul> <p>See page 13-86 for descriptions of the control line operation settings.</p>

**Table 13.22 Define these parameters when configuring a SLC 5/03, 5/04, or 5/05 processor as a slave station. (Continued)**

Tab	Parameter	Default	Selections
	Error Detection	CRC	<p>With this selection, you choose the how the processor checks the accuracy of each DF1 packet transmission.</p> <p>BCC: This algorithm provides a medium level of data security. It cannot detect:</p> <ul style="list-style-type: none"> <li>• transposition of bytes during transmission of a packet.</li> <li>• the insertion or deletion of data values of zero within a packet.</li> </ul> <p>CRC: This algorithm provides a higher level of data security.</p> <p>Select an error detection method that all devices in your configuration can use.</p> <p>When possible, choose CRC.</p>
	Duplicate Packet Detect	Checked	<p>Duplicate Detect lets the SLC detect if it has received a message that is a duplicate of its most recent message from the master station. If you choose duplicate detect, the processor will acknowledge (ACK) the message but will not act on it since it has already performed the message's task when it received the command from the first message.</p> <p>If you want to detect duplicate packets and discard them, leave this parameter checked. If you want to accept duplicate packets and execute them, uncheck this parameter.</p>
	Poll Timeout	3000	<p>The timer keeps track of how often in 20 ms increments that the station is polled. If the station has a message to send, it starts the timer.</p> <p>If the poll timeout expires before the message timeout, which you specify in the MSG control block, the MSG error bit is set and the message is removed from the transmit queue.</p> <p>If the message timeout, which you specify in the MSG control block, expires before the poll timeout expires, the MSG error bit and MSG timeout bit are set. You should always make the MSG timeout greater than the poll timeout so this does not happen.</p> <p>The poll timeout can be disabled by entering a zero. See page page 13-73 for recommendations to minimize this value</p>
	RTS Off Delay	0	<p>Defines the amount of time in 20 millisecond increments that elapses between the end of the message transmission and the de-assertion of the RTS signal. This time delay is a buffer to make sure that the modem has transmitted the message, but should normally be left at zero. See page 13-89 for further guidelines for setting this parameter.</p>
	RTS Send Delay	0	<p>Defines the amount of time in 20 millisecond increments that elapses between the assertion of the RTS signal and the beginning of the message transmission. This time allows the modem to prepare to transmit the message. The Clear-to-Send (CTS) signal must be high for transmission to occur. See page 13-89 for further guidelines for setting this parameter.</p>

**Table 13.22 Define these parameters when configuring a SLC 5/03, 5/04, or 5/05 processor as a slave station. (Continued)**

Tab	Parameter	Default	Selections
	Message Retries	3	Defines the number of times a slave station resends its message to the master station before the slave station declares the message undeliverable.
	Pre-Transmit Delay	0	Defines the amount of time in 1 millisecond increments that elapses between when the processor has a message to send and when it asserts the RTS signal (if handshaking is selected) or begins transmitting (if no handshaking is selected).
	EOT Suppression	Unchecked	If you want to minimize traffic on the network, you can choose to have the slave station not send EOT packets to the master station. When EOT packets are suppressed, the master station automatically assumes a slave station has no data to give if the slave station does not send a message packet as a response to a poll. A disadvantage of suppressing EOTs is that the master station cannot distinguish between an active station that has no data to transmit and an inactive station. A possible application for suppressing EOTs is the following: conserving power with a radio modem because the radio transmitter does not have to power-up to transmit a DLE EOT packet (no data to give packet). To suppress EOTs, check this parameter. To have the processor send EOTs, leave this parameter unchecked.

## Configuring Channel 0 Poll Timeout

The Channel 0 Poll Timeout is only used when the DF1 half-duplex slave is initiating MSG instructions in ladder logic. This implies that the Master is most likely configured for Standard Polling Mode. The minimum Poll Timeout value is dependent on the maximum Master poll scan rate. Since the Master's polling and the Slave's triggering of a MSG instruction are asynchronous events, it is possible that in the instant just after the slave was polled, the MSG instruction gets triggered. This means the MSG instruction will remain queued-up for transmission until the Master has polled every other slave first. Therefore, the minimum Slave channel 0 Poll Timeout value is equal to the maximum Master poll scan rate rounded up to the next 20 ms increment.

$$\text{Minimum Channel 0 Poll Timeout} = (\text{maximum Master scan poll rate})$$

## DF1 Half-duplex Slave Channel Status

Channel Status data is stored in the diagnostic file defined on the Channel 0 Configuration screen. See Table 13.23 for information regarding the diagnostic counter data displayed.

Double-click on the Channel Status Icon Located beneath the Configuration icon to bring up the Channel Status screen.



See Table 13.23 for details concerning the DF1 Half-Duplex Slave Channel Status Screen.

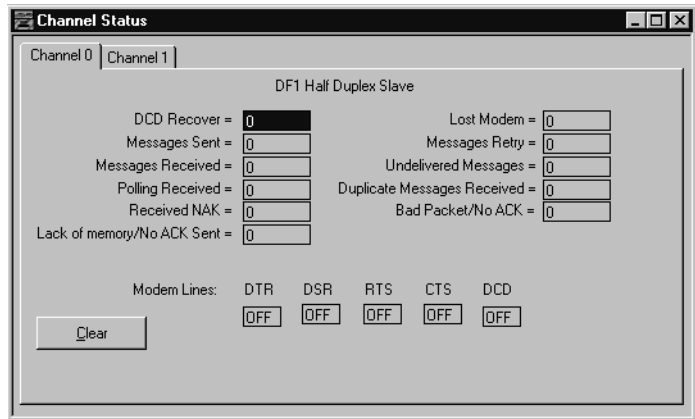

**Table 13.23 SLC 5/03 and Higher Channel 0 DF1 Half-duplex Slave Channel Status**

Status Field	Diagnostic File Location	Definition
DCD Recover	word 11	The number of times the processor detects the DCD handshaking line has gone low to high
Messages Sent	word 1	The total number of DF1 messages sent by the processor (including message retries)
Messages Received	word 2	The number of messages received with no errors
Polling Received	word 6	The number of master poll packets received by the processor
Received NAK	word 5	The number of NAKs received by the processor
Lack of Memory/No ACK Sent	word 8	The number of times the processor could not receive a message because it did not have available memory
Lost Modem	word 12	The number of times the lost modem bit has gone low to high

**Table 13.23 SLC 5/03 and Higher Channel 0 DF1 Half-duplex Slave Channel Status (Continued)**

Status Field	Diagnostic File Location	Definition
Messages Retry	word 4	The number of message retries sent by the processor
Undelivered Messages	word 3	The number of messages that were sent by the processor but not acknowledged by the destination device
Duplicate Messages Received	word 9	The number of times the processor received a message packet identical to the previous message packet
Bad Packet/No ACK	word 7	The number of incorrect data packets received by the processor for which no ACK was returned
DTR (Data Terminal Ready)	word 0;bit 4	The status of the DTR handshaking line (asserted by the processor)
DSR (Data Set Ready)	word 0;bit 2	The status of the DSR handshaking line (received by the processor)
RTS (Request to Send)	word 0;bit 1	The status of the RTS handshaking line (asserted by the processor)
CTS (Clear to Send)	word 0;bit 0	The status of the CTS handshaking line (received by the processor)
DCD (Carrier Detect)	word 0;bit 3	The status of the DCD handshaking line (received by the processor)

For processors running OS Series C, FRN 6 and higher, clicking the Clear button while monitoring Channel Status of either channel 1 or channel 0 online, will reset all of the channel status diagnostic counters for both channels to zero. Prior to OS Series C, FRN 6 the only channel status diagnostic counters that are reset when the Clear button is clicked are the ones on the channel that the programming terminal is connected to. For example, if your programming terminal is connected online via channel 0 and you are monitoring the Channel Status of channel 1, when you click on the Clear button, only channel 0 diagnostic counters will be reset, not channel 1 diagnostic counters.

## DF1 Radio Modem Communications

Processors running OS Series C FRN 6 and higher firmware include a new channel 0 system mode driver called DF1 Radio Modem. This driver implements a protocol, optimized for use with radio modem networks, that is a hybrid between DF1 Full-duplex protocol and DF1 Half-duplex protocol, and therefore is not compatible with either of these protocols.

---

**IMPORTANT**

The DF1 Radio Modem driver should only be used among devices that support and are configured for the DF1 Radio Modem protocol.

---

---

**IMPORTANT**

There are some radio modem network configurations that will not work with the DF1 Radio Modem driver. (See DF1 Radio Modem System Limitations on page 13-77.) In these configurations, continue to use DF1 Half-duplex protocol.

---

Like DF1 Full-duplex protocol, DF1 Radio Modem allows any node to initiate to any other node at any time (if the radio modem network supports full-duplex data port buffering and radio transmission collision avoidance). Like DF1 Half-duplex protocol, a node ignores any packets received that have a destination address other than its own, with the exception of broadcast packets, store and forward packets, and passthru packets (see Chapter 14 for more information about channel-to-channel passthru capabilities).

Unlike either DF1 Full-duplex or DF1 Half-duplex protocols, DF1 Radio Modem protocol does not include ACKs, NAKs, ENQs, or poll packets. Data integrity is ensured by the BCC or CRC (recommended) checksum.

The primary advantage of using DF1 Radio Modem protocol for radio modem networks is in transmission efficiency. Each read/write transaction (command and reply) requires only one transmission by the initiator (to send the command) and one transmission by the responder (to return the reply). This minimizes the number of times the radios need to key-up to transmit, which maximizes radio life and minimizes radio power consumption. In contrast, DF1 Half-duplex protocol requires five transmissions for the DF1 Master to complete a read/write transaction with a DF1 Slave - three by the master and two by the slave.

The DF1 Radio Modem driver can be used in a pseudo Master/Slave mode with any radio modems, as long as the designated Master node is the only node initiating MSG instructions, and as long as only one MSG instruction is triggered at a time.

For modern serial radio modems that support full-duplex data port buffering and radio transmission collision avoidance, the DF1 Radio Modem driver can be used to set up a masterless peer-to-peer radio network, where any node can initiate communications to any other node at any time, as long as all of the nodes are within radio range so that they receive each other's transmissions.

DF1 Radio Modem also supports Store & Forward capability in order to forward packets between nodes that are outside of radio range of each other. Each node that is enabled for Store & Forward has a user-configured Store & Forward Table to indicate which received packets it should re-broadcast, based on the packet's source and destination addresses.

A broadcast write command initiated by any DF1 radio modem node is executed by all of the other DF1 radio modem nodes that receive it. No acknowledgement or reply is returned.

## DF1 Radio Modem System Limitations

The following questions need to be answered in order to determine if you can implement the DF1 Radio Modem driver in your radio modem network:

- Are all of the devices SLC 5/03, 5/04, 5/05, MicroLogix 1100, 1200 or 1500 processors?

If so, the SLC processors must all be at FRN C/6 or higher in order to be configured with the DF1 Radio Modem driver using RSLogix 500 version 5.50 or higher. The MicroLogix 1200 must be Series C, FRN 8 or higher and the MicroLogix 1500 must be Series C FRN 9 or higher. The MicroLogix requires RSLogix 500 version 6.0 or higher to be configured for DF1 Radio Modem. Once channel 0 of the SLC processor is configured for DF1 Radio Modem, you will need to use channel 1 to locally monitor and program your SLC processor using RSLogix 500.

- Do the radio modems require RTS/CTS hardware handshaking?

If so, you need OS Series C, FRN 7 or higher, together with RSLogix 500 version 6.10 or higher.

- Do the radio modems handle full-duplex data port buffering and radio transmission collision avoidance?

If so, then you can take full advantage of the peer-to-peer message initiation capability in every node (for example, the ladder logic in any node can trigger a MSG instruction to any other node at any time). If not, then you may still be able to use the DF1 Radio Modem driver, but only if you limit MSG instruction initiation to a single 'master' node.

- Can I take advantage of the SLC 5/03, 5/04, and 5/05 channel-to-channel passthru to remotely program the other SLC nodes using RSLinx and RSLogix 500 running on a PC connected to a local SLC processor via DH-485, DH+ or Ethernet?

Yes, with certain limitations imposed based on the radio modem network. See the following chapter for more passthru details and limitations when using the DF1 Radio Modem driver.

### Configuring Channel 0 for DF1 Radio Modem

To configure an SLC 5/03, SLC 5/04 or SLC 5/05 processor channel 0 for DF1 Radio Modem, do the following using your programming software.

To bring up the Channel Configuration interface, double-click on the Channel Configuration icon.

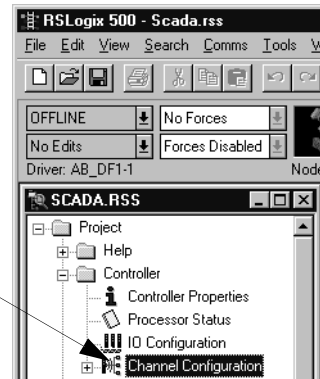

Define the location of the diagnostic file used for Channel Status here. See Table 13.25 on page 13-82 for diagnostic file details.

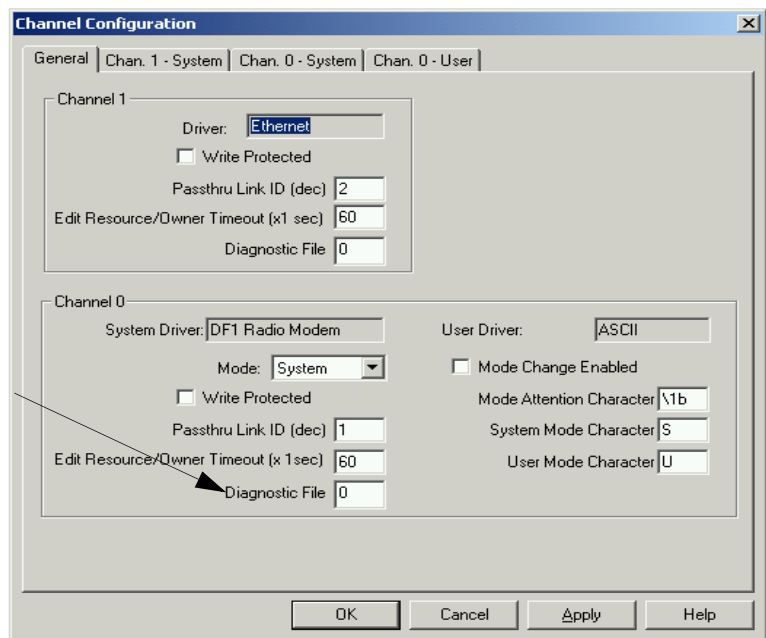



1. On the Channel 0 tab, choose DF1 Radio Modem for your Driver.
2. Configure the communication driver characteristics according to Table 13.24.

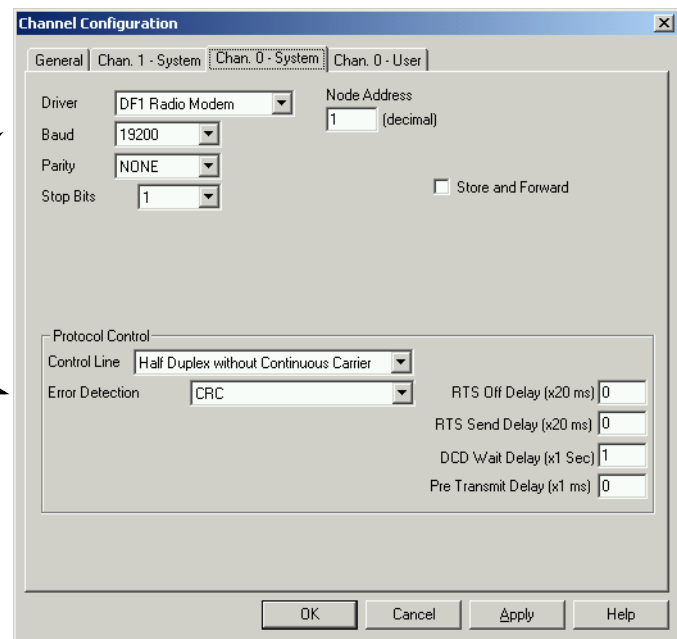

**Table 13.24 Define these communication parameters when configuring a SLC 5/03, 5/04, or 5/05 processor for DF1 Radio Modem communication.**

Tab	Parameter	Default	Selections
General	Diagnostic File	0	Select an unused file (9 to 255) to store channel status information. You must define a diagnostic file in order to be able to view channel 0 status. See Table 13.25 on page 13-82 for a file description.
Chan. 0 System	Baud Rate	19,200	Select a communication rate that all devices in your system support. Configure all devices in the system for the same communication rate.
	Parity	None	Parity provides additional message packet error detection. To implement even parity checking, choose Even. To implement no parity checking, choose None.
	Stop Bits	1	Match the number of stop bits to the devices with which you are communicating.
	Node Address	1	A node address identifies the processor on the DF1 half-duplex link. Each station on a link must have a unique node address. Choose an address between $0_{10}$ and $254_{10}$ . Node address $255_{10}$ is the broadcast address, which you cannot select as a station's individual address.
	Store and Forward <sup>(1)</sup>	Unchecked	When checked, enables Store and Forward capability and duplicate packet detection. Refer to Applying DF1 Radio Modem Protocol on page 13-83 for more information.

**Table 13.24 Define these communication parameters when configuring a SLC 5/03, 5/04, or 5/05 processor for DF1 Radio Modem communication. (Continued)**

Tab	Parameter	Default	Selections
Chan. 0 System	Control Line	No Handshaking	<p>This parameter defines the mode in which the driver operates. Choose a method appropriate for your system's configuration.</p> <ul style="list-style-type: none"> <li>• If you are not using a modem, choose NO HANDSHAKING.</li> <li>• Half-duplex with continuous carrier<sup>(1)</sup></li> <li>• Half-duplex without continuous carrier<sup>(1)</sup></li> </ul> <p>See page 13-86 for descriptions of the control line operation settings</p>
	Error Detection	CRC	<p>With this selection, you choose the how the processor checks the accuracy of each DF1 packet transmission.</p> <p>BCC: This algorithm provides a medium level of data security. It cannot detect:</p> <ul style="list-style-type: none"> <li>• transposition of bytes during transmission of a packet.</li> <li>• the insertion or deletion of data values of zero within a packet.</li> </ul> <p>CRC: This algorithm provides a higher level of data security.</p> <p>Select an error detection method that all devices in your configuration can use.</p> <p>When possible, choose CRC.</p>
	RTS Off Delay <sup>(1)</sup>	0	Defines the amount of time in 20 millisecond increments that elapses between the end of the message transmission and the de-assertion of the RTS signal. This time delay is a buffer to make sure that the modem has transmitted the message, but should normally be left at zero. See page 13-89 for further guidelines for setting this parameter.
	RTS On Delay <sup>(1)</sup>	0	Defines the amount of time in 20 millisecond increments that elapses between the assertion of the RTS signal and the beginning of the message transmission. This time allows the modem to prepare to transmit the message. The Clear-to-Send (CTS) signal must be high for transmission to occur. See page 13-89 for further guidelines for setting this parameter.
	DCD Wait Delay <sup>(1)</sup>	1	Only used with Half-duplex without Continuous Carrier Control Line setting. Defines how long, in seconds, the processor will wait for DCD to go low so that it can transmit, before giving up and erroring out MSG.
	Pre-Transmit Delay	0	Defines the amount of time in 1 millisecond increments that elapses between when the processor has a message to send and when it asserts the RTS signal (if handshaking is selected) or begins transmitting (if no handshaking is selected).

<sup>(1)</sup> OS Series C, FRN 7 and higher.

## DF1 Radio Modem Channel Status

Channel Status data is stored in the diagnostic file defined on the Channel 0 Configuration screen. See Table 13.25 for information regarding the diagnostic counter data displayed.

Double-click on the Channel Status icon Located beneath the Configuration icon to bring up the Channel Status screen.

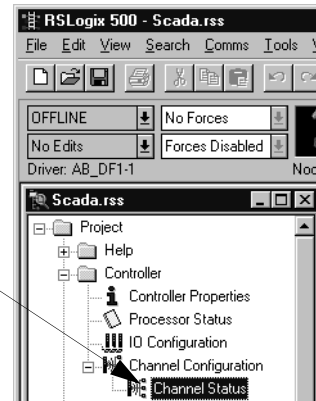

See Table 13.25 for details concerning the DF1 Radio Modem Channel Status Screen.

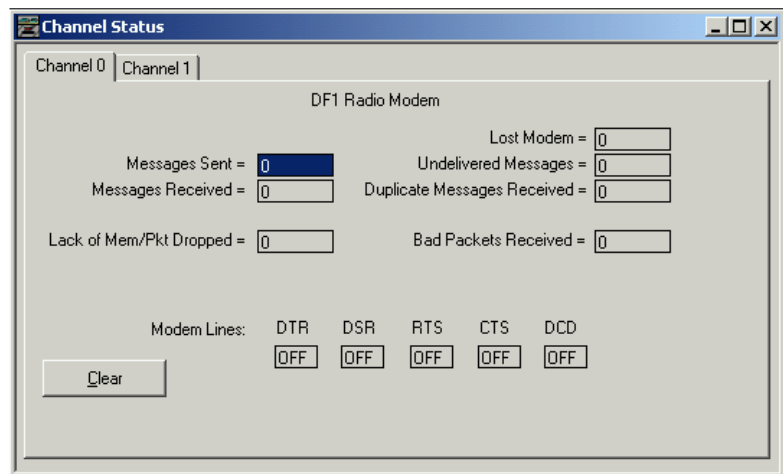

**Table 13.25 SLC 5/03 and Higher Channel 0 DF1 Radio Modem Channel Status**

Status Field	Diagnostic File Location	Definition
Messages Sent	word 1	The total number of DF1 messages sent by the processor
Messages Received	word 2	The number of messages received with no errors
Lack of Memory/Packet Dropped	word 8	The number of times the processor could not receive a message because it did not have available memory
Lost Modem	word 12	The number of times the lost modem bit has gone low to high
Undelivered Messages	word 3	The number of messages that could not be sent by the processor because of incorrect modem handshaking conditions.
Duplicate Messages Received	word 9	The number of times the processor received a message packet identical to the previous message packet
Bad Packets Received	word 7	The number of data packets received with transmission errors by the processor
DTR (Data Terminal Ready)	word 0;bit 4	The status of the DTR handshaking line (asserted by the processor)
DSR (Data Set Ready)	word 0;bit 2	The status of the DSR handshaking line (received by the processor)
RTS (Request to Send)	word 0;bit 1	The status of the RTS handshaking line (asserted by the processor)
CTS (Clear to Send)	word 0;bit 0	The status of the CTS handshaking line (received by the processor)
DCD (Data Carrier Detect)	word 0;bit 3	The status of the DCD handshaking line (received by the processor)

Clicking the Clear button while monitoring Channel Status of either channel 1 or channel 0 online, will reset all of the channel status diagnostic counters for both channels to zero.

## Configuring the Store & Forward Table

The Store & Forward Table occupies status file words S:67 to S:82. Each bit in this range corresponds to a DF1 Radio Modem node address. In order to configure an SLC to Store & Forward message packets between two other nodes, the bits corresponding to the addresses of those two other nodes must be set. For instance, if node 2 is used to Store & Forward message packets between nodes 1 and 3, then both bits S:67/1 and S:67/3 would have to be set in the Store & Forward Table (see Figure 13.14). You can set bit 255 (S:82/15) to enable Store & Forward of broadcast packets, as well.

### IMPORTANT

Once Store & Forward is enabled, duplicate packet detection is also automatically enabled. Whenever Store & Forward is used within a radio modem network, every node should have Store & Forward enabled, even if all of the bits in the file are cleared, so that duplicate packets will be ignored.

**Figure 13.13 Applying DF1 Radio Modem Protocol**

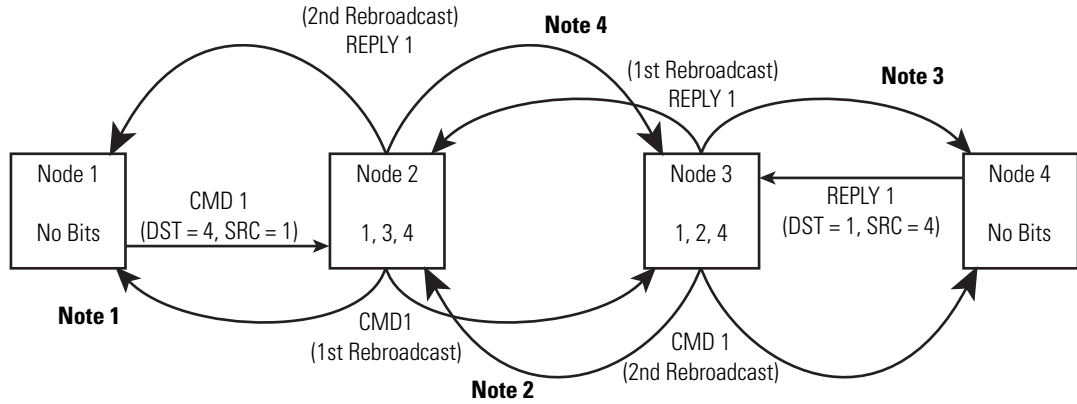

**Note 1** – The link layer of Node 1 blocks the re-transmission of a packet that is received with the SRC byte equal to the receiving node’s station address. Packets received that originate from the receiving node should never be re-transmitted.

**Note 2** – To prevent Node 2 from re-transmitting a duplicate packet, the link layer of Node 2 updates the duplicate packet table with the last 20 packets received.

**Note 3** – The link layer of Node 4 blocks the re-transmission of a packet that is received with the SRC byte equal to the receiving node’s station address. Packets received that originate from the receiving node should never be re-transmitted.

**Note 4** – To prevent Node 3 from re-transmitting a duplicate packet, the link layer of Node 3 updates the duplicate packet table with the last 20 packets received.

**Figure 13.14 Store & Forward Table for Node 2**

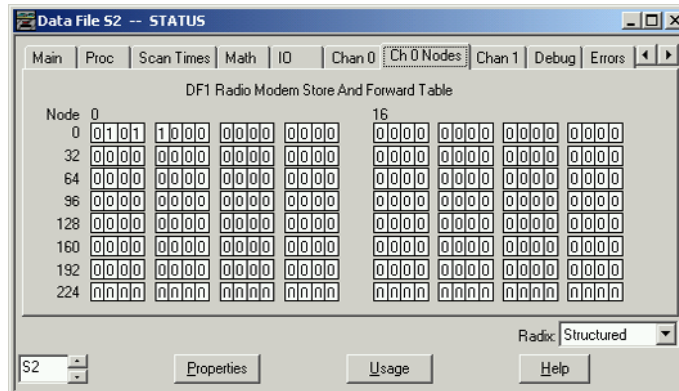

## Using Modems that Support DF1 Communication Protocols

The types of modems that you can use with SLC processors include dial-up phone modems, leased-line modems, radio modems and line drivers. For point-to-point full-duplex modem connections, use DF1 Full-duplex protocol. For radio modem connections, use DF1 Radio Modem. For general point-to-multipoint modem connections, use DF1 Half-duplex Master and Slave protocols. In this case, one (and only one) of the other devices must be configured for DF1 Half-duplex Master protocol. Do not attempt to use DH-485 protocol through modems under any circumstance.

### Dial-up Phone Modems

Dial-up phone line modems support point-to-point full-duplex communications. Normally an SLC processor, on the initiating or receiving end of the dial-up connection, will be configured for DF1 full-duplex protocol with the control line parameter set for Full-duplex Modem. See page 13-86 for details on the operation of the RS-232 modem control signals when Full-duplex Modem is selected.

When an SLC processor is the initiator of the dial-up connection, use one of the ASCII write instructions to send out the AT dial-up string (for example: ATDT 555-1212). The status file modem lost bit (S:5/14) provides the feedback that the connection has been successfully made. To hang up the connection, use the ASCII AHL instruction to temporarily lower the DTR signal.

### Leased-line Modems

Leased-line modems are used with dedicated phone lines that are typically leased from the local phone company. The dedicated lines may be in a point-to-point topology supporting full-duplex communications between two modems or in a point-to-multipoint topology supporting half-duplex communications between three or more modems. In the point-to-point topology, configure the SLC processor for DF1 Full-duplex protocol with the control line parameter set to Full-duplex Modem. In the point-to-multipoint topology, configure the SLC processors for DF1 Half-duplex Master or Slave protocol with the control line parameter set to Half-duplex Modem without Continuous Carrier. See page 13-87 for details on the operation of the RS-232 modem control signals when Half-duplex Modem without Continuous Carrier is selected.

## Radio Modems

Radio modems may be implemented in a point-to-point topology supporting either half-duplex or full-duplex communications, or in a point-to-multipoint topology supporting half-duplex communications between three or more modems. In the point-to-point topology using full-duplex radio modems, configure the SLC processors for DF1 Full-duplex protocol. In the point-to-point topology using half-duplex radio modems, or point-to-multipoint topology using half-duplex radio modems, configure the SLC processors for DF1 Radio Modem protocol. If these radio modems require RTS/CTS handshaking, configure the control line parameter to Half-duplex Modem without Continuous Carrier. See page 13-87 for details on the operation of the RS-232 modem control signals when Half-duplex Modem without Continuous Carrier is selected.

## Line Drivers

Line drivers, also called short-haul modems, do not actually modulate the serial data, but rather condition the electrical signals to operate reliably over long transmission distances (up to several miles). Allen-Bradley's AIC+ Advanced Interface Converter is a half-duplex line driver that converts an RS-232 electrical signal into an RS-485 electrical signal, increasing the signal transmission distance from 50 to 4000 feet. In a point-to-point line driver topology, configure the SLC processor for DF1 full-duplex protocol. In a point-to-multipoint line driver topology, configure the SLC processors for DF1 half-duplex slave protocol. If these line drivers require RTS/CTS handshaking, configure the control line parameter to Half-duplex Modem without Continuous Carrier.

## Modem Control Line Operation in SLC 5/03, SLC 5/04 and SLC 5/05 Processors

The following sections explain the operation of the SLC 5/03, SLC 5/04, and SLC 5/05 modem control when you configure the RS232 channel for a particular modem handshaking method.

### DF1 Full-duplex

When you configure the SLC 5/03, SLC 5/04, and SLC 5/05 processors for full-duplex DF1, the following control line operation takes effect:

**No Handshaking Selected** - DTR is always active and RTS is always inactive. Receptions and transmissions take place regardless of the states of DSR, CTS, or DCD inputs. This selection should only be made when the SLC 5/03, SLC 5/04 and SLC 5/05 processors are directly connected to another DTE device.

**Full-duplex Modem Selected** - DTR and RTS are always active except at the following times. If DSR goes inactive, both DTR and RTS are dropped for 1 to 2 seconds then reactivated. The modem lost bit (S:5/14) is turned on immediately. While DSR is inactive, the state of DCD is ignored. Neither receptions nor transmissions are performed.

If DCD goes inactive while DSR is active, then receptions are not allowed. If DCD remains inactive for 9 to 10 seconds, then DTR is set inactive until DSR goes inactive. At this point, the modem lost bit is also set. If DSR does not go inactive, then DTR is raised again in 5 to 6 seconds.

Transmission requires all three inputs (CTS, DCD, and DSR) to be active. Whenever DSR and DCD are both active, the modem lost bit is reset.

### DF1 Half-duplex Slave

When you configure the SLC 5/03, SLC 5/04, and SLC 5/05 processors for DF1 half-duplex slave, the following control line operation takes effect:

**No Handshaking Selected** - DTR is always active and RTS is always inactive. Receptions and transmissions take place regardless of the states of DSR, CTS, or DCD inputs. This selection should only be made when the processor is directly connected to another DTE device.

**Half-duplex Modem with Continuous Carrier Selected** - DTR is always active and RTS is only activated during transmissions (and any programmed delays before or after transmissions). The handling of DCD and DSR are exactly the same as with Full-duplex Modem. Transmissions require CTS and DSR to be active.



Transmission requires all three inputs (CTS, DCD, and DSR) to be active. Whenever DSR and DCD are both active, the modem lost bit is reset.

**Half-duplex Modem without Continuous Carrier Selected** - This is exactly the same as Half-duplex Modem with Continuous Carrier except monitoring of DCD is not performed. DCD is still required for receptions but is not required for transmissions. Transmissions still require CTS and DSR. The modem lost bit will only be set when DSR is inactive.

## DF1 Half-duplex Master

When you configure the SLC 5/03, SLC 5/04, and SLC 5/05 processors for DF1 half-duplex master, the following control line operation takes effect:

**No Handshaking Selected** - DTR is always active and RTS is always inactive. Receptions and transmissions take place regardless of the states of DSR, CTS, or DCD inputs. This selection should only be made when the processor is directly connected to another DTE device.

**Full-duplex Modem Selected** - DTR and RTS are always active except at the following times. If DSR goes inactive, both DTR and RTS are dropped for 1 to 2 seconds then reactivated. The modem lost bit (S:5/14) is turned on immediately. While DSR is inactive, the state of DCD is ignored. Neither receptions nor transmissions are performed.

If DCD goes inactive while DSR is active, then receptions are not allowed. If DCD remains inactive for 9 to 10 seconds, then DTR is set inactive until DSR goes inactive. At this point, the modem lost bit is also set. If DSR does not go inactive, then DTR is raised again in 5 to 6 seconds.

Transmission requires all three inputs (CTS, DCD, and DSR) to be active. Whenever DSR and DCD are both active, the modem lost bit is reset.

**Half-duplex Modem without Continuous Carrier Selected** - DTR is always active and RTS is only active during transmissions (and any programmed delays before and after transmissions). The processor does not monitor DCD.

If DSR goes inactive, RTS is dropped. The modem lost bit (S:5/14) is turned on immediately. While DSR is inactive, neither receptions nor transmissions are performed.

Transmission requires two inputs, CTS and DSR, to be active. Whenever DSR is active, the modem lost bit is reset.

## DF1 Radio Modem

When you configure the SLC 5/03, SLC 5/04, and SLC 5/05 processors for DF1 Radio Modem, the following control line operation takes effect:

**No Handshaking Selected** - DTR is always active and RTS is always inactive. Receptions and transmissions take place regardless of the states of DSR, CTS, or DCD inputs. This selection should only be made when the processor is directly connected to another DTE device.

**Half-duplex with Continuous Carrier Selected-** DTR is always active. RTS is activated during transmission and during any programmed delays before or after transmissions. Programmed delays include RTS Send delay and RTS Off Delay. The DSR input signal must remain active for transmissions or receptions to occur. The modem lost bit is set whenever DSR is inactive. The DCD input signal is ignored.

Transmission requires CTS and DSR to be active. If CTS is inactive at the onset of transmission, one second will be provided to wait for CTS to become active before the message packet is discarded.

**Half-duplex without Continuous Carrier Selected-** DTR is always active. RTS is activated during transmissions and during any programmed delays before and after transmissions. Programmed delays include RTS Send Delay and RTS Off Delay. The DSR input signal must remain active for transmissions or receptions to occur. The modem lost bit is set whenever DSR is inactive. The DCD input signal is monitored to determine if transmissions are acceptable. If DCD is active, receptions are possible.

Transmission requires CTS and DSR to be active and DCD to be inactive. If DCD is active at the onset of transmission, a configurable delay (DCD Wait Delay) will wait for DCD to become inactive before discarding the packet. If CTS is inactive at the onset of transmission, one second will be provided to wait for CTS to become active before the message packet is discarded.

## Modbus RTU Master

When you configure the SLC 5/03, SLC 5/04, and SLC 5/05 processors for Modbus RTU Master, the following control line operation takes effect:

**No Handshaking** - DTR is always active and RTS is always inactive. Receptions and transmissions take place regardless of the states of DSR, CTS, or DCD inputs. This selection should only be made when the processor is directly connected to another DTE device.

**Full Duplex Modem** - DTR and RTS are always active except at the following times. If DSR goes inactive, modem lost bit (S:5/14) is turned on immediately. While DSR is inactive, neither reception nor transmission is performed. The processor does not monitor DCD. Transmission requires CTS & DSR inputs to be active. .

**Half Duplex without Continuous Carrier** - DTR is always active and RTS is only active during transmissions (and any programmed delays before and after transmissions). The processor does not monitor DCD.

If DSR goes inactive, RTS is dropped. The modem lost bit (S:5/14) is turned on immediately. While DSR is inactive, neither receptions nor transmissions are performed. Transmission requires two inputs, CTS and DSR, to be active. Whenever DSR is active, the modem lost bit is reset.

## RTS Send Delay and RTS Off Delay Parameters

Through your programming software, the parameters RTS Send Delay and RTS Off Delay give you the flexibility of selecting modem control during transmissions. These parameters only apply when you select half-duplex modem with or without continuous carrier.

For use with half-duplex modems that require extra time to “key up” their transmitter even after they have activated CTS, the RTS Send Delay specifies in 20 millisecond increments the amount of delay time after activating RTS to wait before checking to see if CTS has been activated by the modem. If CTS is not yet active, RTS remains active and as long as CTS is activated within one second, the transmission occurs. After one second, if CTS is still not activated, then RTS is set inactive and the transmission is aborted.

For modems that do not supply a CTS signal at all, tie RTS to CTS and use the shortest delay possible without losing reliable operation.

### TIP

If an RTS Send Delay of 0 is selected, then transmission starts as soon as CTS is activated. If CTS does not go active within 1 second after RTS is raised, RTS is set inactive and the transmission is aborted.

Certain modems will drop their carrier link when RTS is lost even though the transmission has not been finished yet. The RTS Off Delay parameter specifies in 20 millisecond increments the delay between when the last serial character is sent to the modem and when RTS is deactivated. This gives the modem extra time to transmit the last character of a packet.

## Modbus RTU Protocol

This section shows the configuration parameters for Modbus RTU (Remote Terminal Unit transmission mode) protocol. For more information about the Modbus RTU protocol, see the Modbus Protocol Specification (available from <http://www.modbus.org>).

SLC 5/03, SLC 5/04, and SLC 5/05 support Modbus RTU Master from Series C FRN11 onwards.

### Modbus RTU Master

Message instructions are used to transfer information between the data files in the Modbus RTU Master and the Modbus RTU Slaves. See the section, *Configuring a Channel for Modbus RTU Master*, for detailed information about configuring a MSG instruction for Modbus Communications.

Modbus addressing is limited to 16 bits per memory group, each with a range of 1 to 65,536. There are four memory groups, one for each function:

- coils (generally addressed as 0xxxx)
- contacts (1xxxx)
- input registers (3xxxx)
- holding registers (4xxxx)

Coils and contacts are addressed at the bit level. Coils are like outputs and can be read and written to. Contacts are like inputs and are read-only. Input registers and holding registers are addressed at the word level. Input registers are generally used for internally storing input values. They are read-only. Holding registers are general purpose and can be both read and written to.

The most significant digit of the address is considered a prefix, and does not get entered into the Modbus Data Address field when configuring the message instruction.

When the message is sent, the address is decremented by 1 and converted into a 4-character hex number to be transmitted via the network (with a range of 0-FFFFh); the slave increments the address by 1, and selects the appropriate memory group based on the Modbus function.

**IMPORTANT**

Modbus protocol may not be consistently implemented in the field. The Modbus specification calls for the addressing range to start at 1; however, some devices start addressing at 0.

The Modbus Data Address in the Message Setup Screen may need to be incremented by one to properly access a Modbus slave's memory, depending on that slave's implementation of memory addressing.

## Configuring a Channel for Modbus RTU Master

To configure a channel for Modbus RTU master, first place the processor into program mode and do the following using your programming software:

To bring up the Channel Configuration interface, double-click on the Channel Configuration icon.



Define the location of the diagnostic file used for Channel Status here. For Channel Status details, see page 13-94.

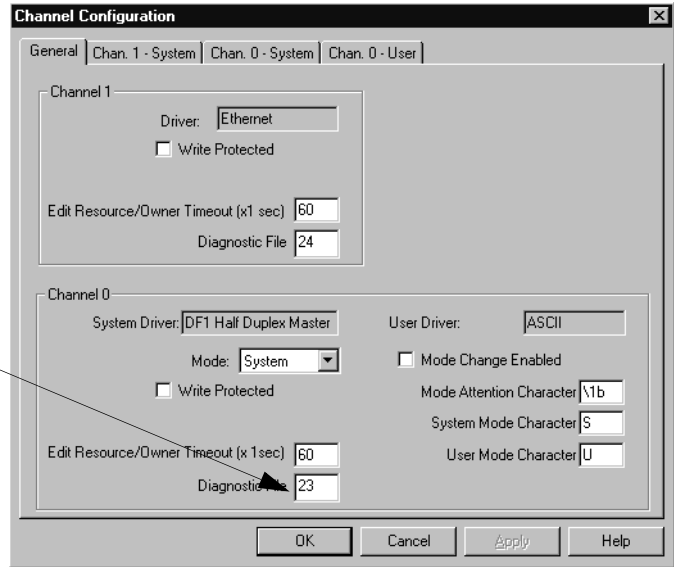

Select the Modbus RTU Master from the Channel Configuration menu as shown below.

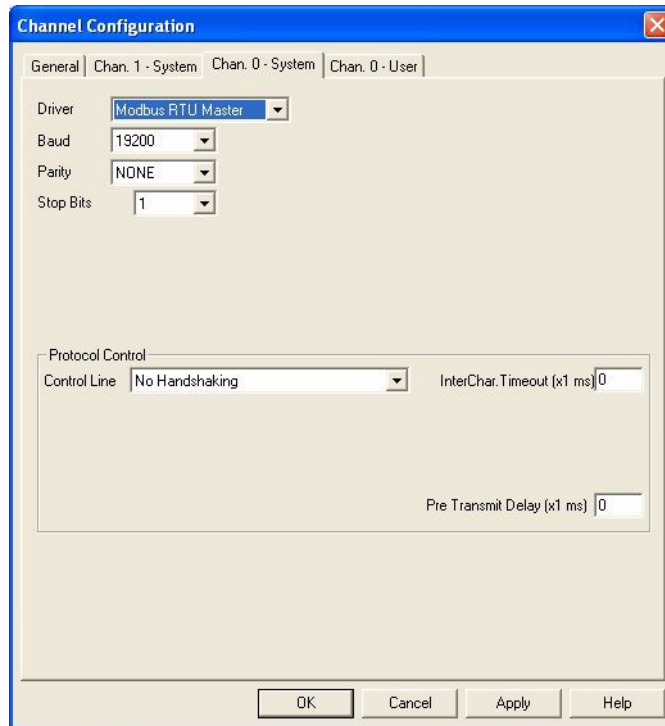

The Baud defaults to 19200.

The Control Line can be configured as:

- No Handshaking
- Full-Duplex Modem
- Half Duplex without Continuous Carrier

The Protocol Control defaults are:

- No Handshaking
- InterChar. Timeout = 0
- Pre Transmit Delay = 0.

When the system driver is Modbus RTU Master, the following communication port parameters can be changed:

**Table 13.26 Modbus RTU Master Channel Configuration Parameters**

Parameter	Options	Programming Software Default
Channel	Channel 0	0
Driver	Modbus RTU Master	
Baud Rate	110, 300, 600, 1200, 2400, 4800, 9600, 19.2K, 38.4K	19.2K
Parity	none, even, odd	none
Control Line	No Handshaking, Full-Duplex Modem, Half-Duplex without Continuous Carrier	No Handshaking
Inter-character Timeout (x1 ms)	0 to 65535 (can be set in 1 ms increments); 0 = 3.5 character times Specifies the minimum delay between characters that indicates the end of a message packet.	0
RTS Off Delay (x20 ms)	0 to 65535 (can be set in 20 ms increments) Specifies the delay time between when the last serial character is sent to the modem and when RTS is deactivated. Gives the modem extra time to transmit the last character of a packet.	0
RTS Send Delay (x20 ms)	0 to 65535 (can be set in 20 ms increments) Specifies the time delay between setting RTS until checking for the CTS response. For use with modems that are not ready to respond with CTS immediately upon receipt of RTS.	0
Pre Transmit Delay (x1 ms)	0 to 65535 (can be set in 1 ms increments) When the Control Line is set to <i>No Handshaking</i> or <i>Full-Duplex Modem</i> , this is the delay time before transmission. Required for 1761-NET-AIC physical Half-Duplex networks. The 1761-NET-AIC needs 2 ms of delay time to change from receive to transmit mode. When the Control Line is set to <i>Half-Duplex Modem</i> , this is the minimum time delay before RTS assertion.	0
Stop Bits	1, 1.5, 2	1

## Modbus RTU Master Channel Status

Channel Status data is stored in the diagnostic file defined on the Channel 0 Configuration screen.

Double-click on the Channel Status Icon Located beneath the Configuration icon to bring up the Channel Status screen.

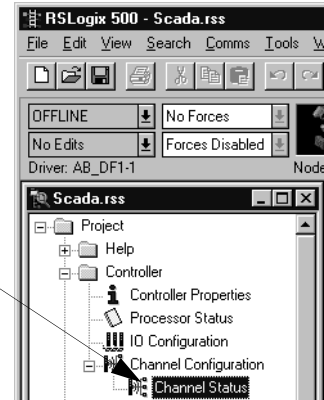

The Channel Status dialog box similar to the following appears. Data for the data link layer diagnostic counters is displayed. See Table 13.27 for information regarding the diagnostic counter data displayed.

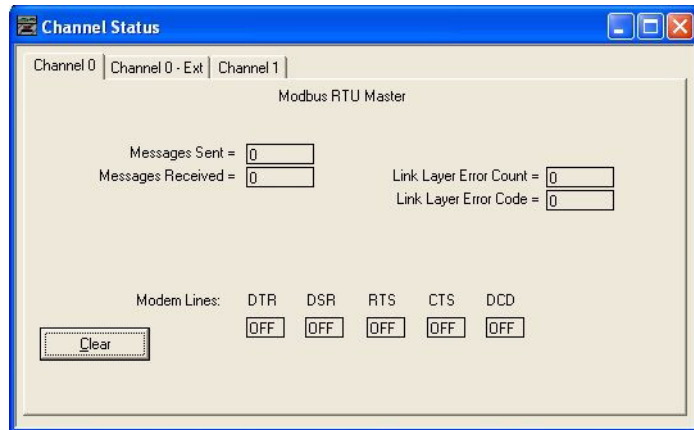
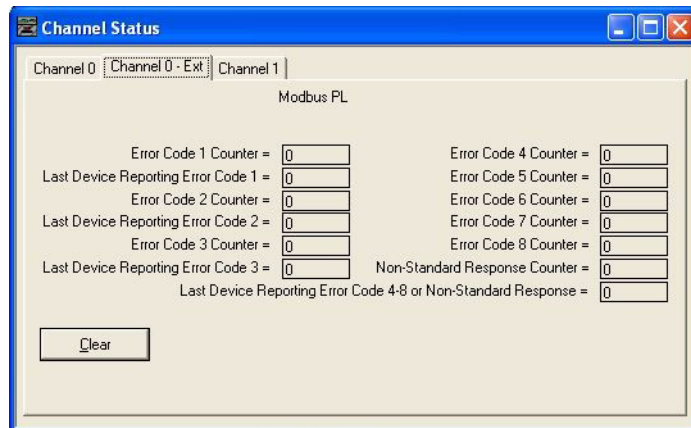



**Table 13.27 SLC 5/03 and Higher Channel 0 Modbus RTU Master Channel Status**

<b>Data Link Layer Diagnostic Counters (Modbus Master RTU)</b>		
<b>Status Field</b>	<b>Diagnostic File Location</b>	<b>Definition</b>
DTR	Word 0; Bit 4	DTR (Data Terminal Ready)
DCD	Word 0; Bit 3	DCD (Data Carrier Detect)
DSR	Word 0; Bit 2	DSR (Data Set Ready)
RTS	Word 0; Bit 1	RTS (Request to Send)
CTS	Word 0; Bit 0	CTS (Clear to Send)
Messages Sent	Word 1	Total Message Packets Sent
Messages Received	Word 2	Total Message Packets Received
Link Layer Error Count	Word 3	Link Layer Error Count
Link Layer Error Code	Word 4	Link Layer Error Code

Click the Channel 0 - Ext tab to display data for the PL diagnostic counters. See Table 13.28 for information regarding the diagnostic counter data displayed.



**Table 13.28 SLC 5/03 and Higher Channel 0 Modbus RTU Master Channel Status**

<b>PL Diagnostic Counters (Modbus Master RTU)</b>	
<b>Status Field/Description</b>	<b>Diagnostic File Location</b>
Error Code 1 Counter	Word 7
Last Device Reporting Error Code 1	Word 8
Error Code 2 Counter	Word 9
Last Device Reporting Error Code 2	Word 10
Error Code 3 Counter	Word 11

**Table 13.28 SLC 5/03 and Higher Channel 0 Modbus RTU Master Channel Status**

<b>PL Diagnostic Counters (Modbus Master RTU)</b>	
<b>Status Field/Description</b>	<b>Diagnostic File Location</b>
Last Device Reporting Error Code 3	Word 12
Error Code 4 Counter	Word 13
Error Code 5 Counter	Word 14
Error Code 6 Counter	Word 15
Error Code 7 Counter	Word 16
Error Code 8 Counter	Word 17
Non-Standard Response Counter	Word 18
Last Device Reporting Error Code 4-8 or Non-Standard Response	Word 19

If you click the Clear button while monitoring Channel Status online, it will reset all the channel status diagnostic counters to zero.

## Modbus Commands

The controller configured for Modbus RTU Master responds to the Modbus command function codes listed in the following table:

**Table 13.29 Supported Modbus Commands as a Modbus RTU Master**

<b>Command</b>	<b>Function Code (decimal)</b>	<b>Subfunction Code (decimal)</b>
Read Coil Status	1	-
Read Input Status	2	-
Read Holding Registers	3	-
Read Input Registers	4	-
Write Single Coil <sup>(1)</sup>	5	-
Write Single Holding Register <sup>(1)</sup>	6	-
Write Multiple Coils <sup>(1)</sup>	15	-
Write Multiple Holding Registers <sup>(1)</sup>	16	-

<sup>(1)</sup> Broadcast is supported for this command.

## Modbus Error Codes

Upon receiving a Modbus command that is not supported or improperly formatted, the controller configured for Modbus RTU Master will respond with one of the exception codes listed in the following table:

**Table 13.30 Modbus Error Codes in Modbus RTU Master MSG Instruction**

Error Code	Error	Description	Received Exception Code
81	Illegal Function	The function code sent by the Master is not supported by the slave or has an incorrect parameter.	1
82	Illegal Data Address	The data address referenced in the Master command does not exist in the slave, or access to that address is not allowed.	2
83	Illegal Data Value	The data value being written is not allowed, either because it is out of range, or it is being written to a read-only address.	3
84	Slave Device Failure	An unrecoverable error occurred while the slave was attempting to perform the requested action.	4
85	Acknowledge	The slave has accepted the request, but a long duration of time will be required to process the request.	5
86	Slave Device Busy	The slave is currently processing a long-duration command.	6
87	Negative Acknowledge	The slave cannot perform the program function received in the command.	7
88	Memory Parity Error	The slave attempted to read extended memory, but detected a parity error in the memory.	8
89	Non-standard Error Code	An error code greater than 8 was returned by the slave.	>8

## ASCII Communications

The SLC 5/03 (OS301 and higher), SLC 5/04, and SLC 5/05 processors support user-defined ASCII protocol by configuring channel 0 for User mode. In User mode, all received data is placed in a buffer. To access the data, use the ASCII instructions in your ladder program. You can also send ASCII string data to most attached devices that accept ASCII protocol.

**TIP**

Only ASCII instructions can be used when User mode is configured. If you use a Message (MSG) instruction that references channel 0, a 14H error occurs.

## Configuring Channel 0 for ASCII Communications

To configure an SLC 5/03, SLC 5/04 or SLC 5/05 processor channel 0 for ASCII communications, do the following using your programming software.

To bring up the Channel Configuration interface, double-click on the Channel Configuration icon.

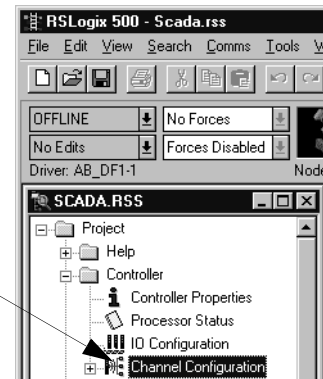

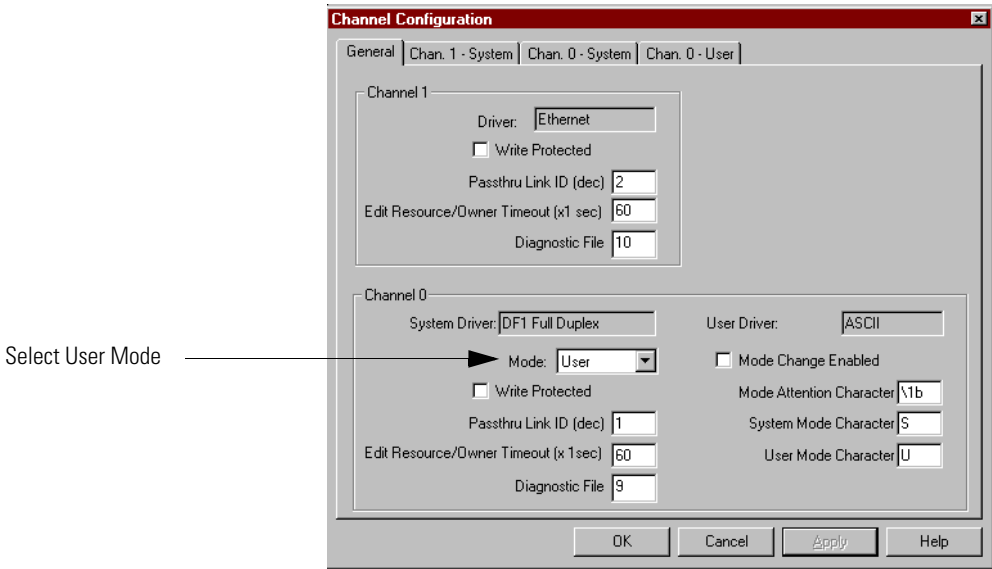

- 1. On the Channel 0 user tab, choose ASCII for your Driver.
- 2. Configure the communication driver characteristics according to Table 13.31.

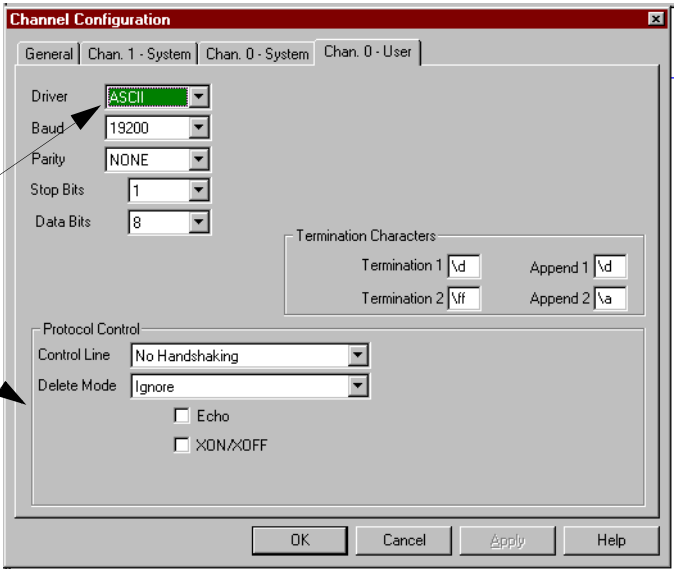

**Table 13.31 Define these communication parameters when configuring an SLC 5/03, SLC 5/04, or SLC 5/05 processor for ASCII communication.**

Tab	Parameter	Default	Selections
Channel 0 User	Baud Rate	19200	Toggles between the communication rate of 110, 300, 600, 1.2K, 2.4K, 4.8K, 9.6K and 19.2K (additional rate of 38.4K for SLC 5/04 and SLC 5/05 only).
	Parity	None	Toggles between None, Odd, and Even.
	Stop Bits	1	Toggles between 1, 1.5, and 2.
	Data Bits	8	Toggles between 7 and 8.
	Delete Mode	Ignore	Toggles between Ignore, CRT, and printer. This parameter is dependent on the Echo parameter being Enabled.
	Echo	Disabled	Toggles between Disabled and Enabled.
	RTS Off Delay	0	Allows you to select the RTS off delay value in increments of 20 ms. Valid range is 0 to 65535 (in 20 ms increment). Only valid for Half-duplex Control Line settings.
	RTS Send Delay	0	Allows you to select the RTS send delay value in increments of 20 ms. Valid range is 0 to 65535 (in 20 ms increment). Only valid for Half-duplex Control Line settings.
	Control Line	No Handshaking	Toggles between No Handshaking, Half-duplex With Continuous Carrier, Half-duplex Without Continuous Carrier, and Full-duplex Modem.
	XON/XOFF	Disabled	Toggles between Disabled and Enabled.
	Termination 1 Termination 2	\d \ff	Specify \ff for no termination character.
	Append 1 Append 2	\d \a	Specify \ff for no append character.

## SLC Passthru Communications

There are three types of communications passthru (or bridging) supported by SLC 5/03, SLC 5/04 and SLC 5/05 processors.

- Remote I/O passthru via the 1747-SN and 1747-BSN remote I/O scanner modules
- DeviceNet passthru via the 1747-SDN DeviceNet scanner module
- Channel-to-channel passthru

The following table summarizes the processor OS firmware/passthru capability.

**Table 14.1 Operating System (OS) Processor Firmware Required for Passthru Capability**

Passthru Capability	Channel 0 DH-485	Channel 0 DF1 Full-duplex	Channel 0 DF1-Half Duplex Master	Channel 0 DF1 Radio Modem	Remote I/O (1747-SN/BSN)	DeviceNet (1747-SDN <sup>(1)</sup> )
<b>Channel 1 EtherNet</b>	OS500 A FRN 1	OS500 A FRN 1	OS501 C FRN 6	OS501 C FRN 6	OS500 A FRN 1	OS500 A FRN 1
<b>Channel 1 DH+</b>	OS400 A FRN 1	OS401 A FRN 5	OS401 C FRN 6	OS401 C FRN 6	OS401 A FRN 5	OS400 A FRN 1
<b>Channel 1 DH-485</b>	OS302 C FRN 7	OS302 C FRN 7	OS302 C FRN 7	OS302 C FRN 7	OS302 A FRN 9	OS300 A FRN 1
<b>Remote I/O (1747-SN/BSN)</b>	OS302 A FRN 9	OS302 A FRN 9	OS302 A FRN 9	OS302 C FRN 6	N/A	N/A
	OS401 A FRN 5	OS401 A FRN 5	OS401 A FRN 5	OS401 C FRN 6		
	OS500 A FRN 1	OS500 A FRN 1	OS500 A FRN 1	OS501 C FRN 6		
<b>DeviceNet (1747-SDN<sup>(1)</sup>)</b>	OS300 A FRN 1	OS300 A FRN 1	OS302 A FRN 9	OS302 C FRN 6	N/A	N/A
	OS400 A FRN 1	OS400 A FRN 1	OS401 A FRN 5	OS401 C FRN 6		
	OS500 A FRN 1	OS500 A FRN 1	OS500 A FRN 1	OS501 C FRN 6		

<sup>(1)</sup> Requires FRN 4.015 or higher firmware.

### Remote I/O Passthru

This type of passthru allows the SLC processor system to act as a bridge between the channel 0 or channel 1 network, and the remote I/O network supported by the 1747-SN and 1747-BSN remote I/O scanner modules. This allows personal computers on Ethernet, DH+, DH-485 or DF1 networks to upload or download applications to devices such as PanelView operator terminals and power monitors on the remote I/O network.

Refer to the remote I/O device software documentation to get details on how to upload and download that device via remote I/O passthru

**IMPORTANT**

Remote I/O passthru uses buffer number 32 in the M0 and M1 files of the remote I/O scanner module. Avoid using these buffers for block transfer read/write instructions if you intend to use the remote I/O passthru capability.

---

## DeviceNet Passthru

DeviceNet passthru allows the SLC processor system to act as a bridge between the channel 0 or channel 1 network, and the DeviceNet network supported by the 1747-SDN DeviceNet scanner module. This allows personal computers on Ethernet, DH+, DH-485 or DF1 networks to upload or download applications to devices such as PanelView operator terminals and power monitors on the DeviceNet network.

The minimum firmware revision level of the 1747-SDN that supports passthru is 4.015, and the minimum RSLinx revision with a 1747-SDN passthru driver (1747-SDNPT) is version 2.00. For 1747-SDN firmware revisions from 4.015 to 5.001, the module M0/M1 file size must be configured offline by RSLogix 500 to be a length of 361 (words) in order for passthru to work. For 1747-SDN firmware revisions 6.002 and higher, the module M0/M1 file size must be set to a length of 395 (words) in order for passthru to work. This M-file increase accommodates larger passthru messages, which now allows DeviceNet PanelView applications to successfully download. This also requires an enhanced 1747-SDNPT passthru driver in RSLinx version 2.31, or higher, which will adjust the passthru packet size based on the SDN firmware revision level.

**TIP**

DeviceNet passthru is recommended for an occasional upload, download, or the configuration of one parameter at a time; not a complete network startup. This capability is not a replacement for a dedicated DeviceNet computer interface such as a 1770-KFD, 1784-PCD, or 1784-PCID.

## Channel-to-channel Passthru

SLC 5/03, 5/04 and 5/05 processors have two communication channels, 0 and 1, allowing the processor to be connected to two separate networks. Channel-to-channel passthru allows devices connected on one of the networks to communicate with devices on the other network using the SLC processor as a communications bridge. When passthru is enabled, this communications bridging occurs whether the processor is in Program mode or Run mode. In Run mode, the processor services passthru communications along with other



processor communications during end-of-scan. In program mode, the processor continuously services communications including passthru.

**TIP**

Channel-to-channel passthru only works for single hop bridging. One end node must be connected to the channel 0 network and the other end node must be connected to the channel 1 network. The channel 1 passthru link ID must match the network link ID of the end node connected on the channel 1 network. If channel 0 is configured for DH-485, then channel 0 passthru link ID must match the network link ID of the end node connected on the channel 0 DH-485 network.

The Passthru Link IDs for channel 0 and channel 1 are configured on the General tab of the Channel Configuration screen. The default Passthru Link IDs are one for channel 0 and two for channel 1. Valid Link IDs are 1 to 65,534.

**IMPORTANT**

SLC remote message instructions can only be configured to bridge to remote networks configured with link IDs in the range of 1 to 254.

Devices on the channel 1 network can initiate remote packets through the passthru processor by setting the destination link ID equal to the passthru processor's channel 0 link ID. If channel 0 is configured for DH-485, then devices on the channel 0 DH-485 network can initiate remote packets through the passthru processor by setting the destination link ID equal to the passthru processor's channel 1 link ID.

When channel 0 is configured for DF1 Full-duplex protocol, the DF1 destination address becomes the channel 1 destination address. When channel 0 is configured for DF1 Half-duplex Master or DF1 Radio Modem protocol, the DF1 destination address is 128 plus the channel 1 destination address. This allows addresses 0 to 127 to be used within the DF1 Half-duplex or Radio Modem networks, and addresses 128 and above to be used for passthru. Valid channel 1 destination addresses are 0 to 31 for the 5/03, 0 to 63 (or 0 to 77 octal) for the 5/04 and 1 through up to 126 for the 5/05 depending on how many valid IP addresses are entered into the Passthru Routing Table. DF1 Full-duplex packets received with a destination address equal to the passthru processor's channel 1 network address or outside of the valid channel 1 address range are kept and executed by the passthru processor. DF1 Half-duplex Master and DF1 Radio Modem packets received with a

destination equal to 128 plus the processor's channel 1 network address are kept and executed by the passthru processor. DF1 Half-duplex Master packets received with a destination address outside of the valid channel 1 address range are rebroadcast as slave-to-slave messages. DF1 Radio Modem packets received with a destination address outside of the valid channel 1 address range are ignored.

Channel-to-channel passthru is enabled using one of two different status file bits, depending on whether channel 0 is configured for DH-485 or DF1 protocols. Depending on firmware revision, valid DF1 protocols for passthru are Full-duplex only or Full-duplex, Half-duplex Master and Radio Modem.

If channel 0 is configured for DH-485, S:34/0 enables and disables channel-to-channel passthru as follows.

- If S:34/0 is 0 (default setting), channel-to-channel passthru is enabled.
- If S:34/0 is 1, channel-to-channel passthru is disabled.

If channel 0 is configured for DF1, S:34/5 enables and disables channel-to-channel passthru as follows.

- If S:34/5 is 0 (default setting), channel-to-channel passthru is disabled.
- If S:34/5 is 1, channel-to-channel passthru is enabled.

---

**IMPORTANT**

For the SLC 5/05, a valid passthru routing table file number must also be configured in order to enable channel-to-channel passthru.

---

## Additional SLC 5/03 Passthru Status Bits

The SLC 5/03 has two additional status file bits associated with channel-to-channel passthru. The bits are:

- DF1 Remote/Local Passthru bit (S:34/6).
- Local Passthru Queue Full bit (S:34/7).

The DF1 Remote/Local Passthru bit controls whether DF1 commands received by channel 0 are passed through to the channel 1 DH-485 network as remote DH-485 packets (S:34/6=0) or as local DH-485 packets (S:34/6=1). The DF1 Remote/Local Passthru bit only affects passthru operation when channel 0 is configured for DF1 and channel-to-channel passthru is enabled (S:34/5=1)

**TIP**

The SLC 500 Fixed, SLC 5/01, SLC 502, ControlLogix, FlexLogix, and CompactLogix controllers can only respond to local DH-485 packets. Set S34/6=1 when using SLC 5/03 channel-to-channel passthru to communicate with the SLC 500 Fixed, SLC 5/01, SLC 502, ControlLogix, FlexLogix, and CompactLogix controllers via DH-485 on channel 1.

The Local Passthru Queue Full bit is a monitor only bit that is set to a one anytime this 30-slot local passthru queue becomes full. The local passthru queue can be flushed at anytime by executing the ACL instruction with the Receive Buffer set to No and the Transmit Buffer set to Yes.

When the DF1 Remote/Local Passthru bit is set to Local, any DF1 commands received at channel 0 and passed through to channel 1 DH-485 are stored in a 30-slot local passthru queue until a reply is received from the channel 1 DH-485 network. This is done so that the processor can determine whether local replies received on the channel 1 DH-485 are for MSG instructions initiated by the processor or for passthru back to the channel 0 DF1 network. If a DH-485 device that is actively passing the token does not reply to the DF1 command, one slot in the 30-slot local passthru queue will be lost until the next power cycle.

**TIP**

As the Local Passthru Queue approaches capacity, S34/7 may toggle between 0 and 1. To verify that the Local Passthru Queue is completely full, use the Local Passthru Queue Full bit as a pre-condition to a timer (TON) with a preset of ten seconds or longer. Then use the timer done bit as a pre-condition for executing the ACL instruction.

## Using RSLinx Classic, version 2.50 and higher, with SLC 5/03 Passthru

RSLinx Classic, version 2.42 and below, only supports channel 0 to channel 1 passthru, when channel 0 is configured for DF1 Full-duplex or DF1 Half-duplex Master. RSLinx Classic, version 2.43 supports all modes of channel-to-channel passthru described below, except when channel 0 control line handshaking is enabled. RSLinx Classic, version 2.50 and higher supports all modes of channel-to-channel passthru as described below.

When channel 0 is configured for DF1 Full-duplex and S:34/5=1, the SLC 5/03 passthru processor can be used by RSLinx to go online through channel 0 to the channel 1 DH-485 network. The RSLinx RS-232 DF1 driver is used, with Device configured for 1770-KF3/1747-KE. Remember to set S:34/6=1 if attempting to browse or go online with SLC 500 fixed, SLC 5/01, SLC 5/02, ControlLogix, FlexLogix, and/or CompactLogix controllers on DH-485. The passthru processor will show up on the RSWho browse at its DH-485 node address.

---

**IMPORTANT**

In order to download a DH-485 PanelView standard terminal using RSLinx in this passthru setup, the DF1 remote/local passthru bit must be cleared (S:34/6=0).

---

When channel 0 is configured for DF1 Half-duplex Master and S:34/5=1, the SLC 5/03 passthru processor can be used by RSLinx to go online through channel 0 to the channel 1 DH-485 network. The RSLinx DF1 Slave driver is used. The SLC 5/03 passthru processor channel 0 configuration must be set up in Standard Polling Mode, and the slave address of RSLinx must be included in the polling range. The DF1 Slave driver properties in RSWho must be modified to poll for the valid 5/03 DF1 Half-duplex Master passthru range of addresses, which is 128 to 159 (for DH-485 nodes 0 to 31). The S:34/6=1 should be set if attempting to browse or go online with SLC 500 fixed, SLC 5/01, SLC 5/02, ControlLogix, FlexLogix, or CompactLogix controllers on DH-485. The passthru processor will show up on the RSWho browse at 128 plus its DH-485 node address.

When channel 0 is configured for DH-485 and S:34/0=0, the SLC 5/03 passthru processor can be used by RSLinx to go online through channel 0 to the channel 1 DH-485 network, when the PC running RSLinx is directly connected to the channel 0 DH-485 network through a 1784-KTX(D), 1784-PKTX(D), or 1784-PCMK card. When RSWho is browsing the SLC 5/03 on DH-485 with S:34/0=0, then a '+' sign will appear to the left of the SLC 5/03 icon. Clicking on the '+' sign will expose a DH-485 network underneath the SLC 5/03 icon. Clicking on the '+' sign to the left of the DH-485 network will result in RSWho browsing for nodes 0 to 31 on the DH-485 network. You should configure the properties of the DH-485 network within RSWho to browse the specific range of the addresses that are being used on the DH-485 network.

When channel 0 is configured for either DF1 Full-duplex, DF1 Half-duplex Master, DF1 Radio Modem (with S:34/5=1), or DH-485 (with S:34/0=0), the SLC 5/03 passthru processor can be used by RSLinx to go online through channel 1 to the channel 0 DF1 or DH-485 network, as long as the PC running RSLinx is directly connected to the DH-485 network through a 1784-KTX(D), 1784-PKTX(D), or 1784-PCMK card. When RSWho is browsing the SLC 5/03 on DH-485, and channel 0 is either configured for

DH-485 with S:34/0=0 or for DF1 Full-duplex with S:34/5=1, then a '+' sign will appear to the left of the SLC 5/03 icon. Clicking on the '+' sign will expose a DH-485 or DF1 network underneath the SLC 5/03 icon. Clicking on the '+' sign to the left of the DH-485 or DF1 network will result in RSWho browsing for nodes 0 to 31 on the DH-485 network or for node 1 on the DF1 network.

Refer to the steps on page 14-13 for browsing multiple nodes when channel 0 is configured for DF1 Half-duplex Master or DF1 Radio Modem.

## **SLC 5/03 Passthru Error Codes**

A SLC 5/03 passthru processor may respond to a MSG instruction or RSLinx with error codes of 20H or 30H, under the following conditions.

- A packet is received in either channel to be passed through to the other channel's DH-485 network, but the DH-485 node at the remote station address is not currently present in the other channel's DH-485 active node table (30H).
- A remote packet is received in either channel where the remote link ID doesn't equal either channel's link ID (20H).
- A remote packet is received in either channel to be passed through to the other channel's DH-485 network, with a remote station address that is equal to the other channel's DH-485 address (20H).
- A remote packet is received in either channel to be passed through to the other channel's DH-485 network, with a remote station address that is greater than 31 (20H).
- A DF1 packet is received in channel 0 to a valid DH-485 destination address with S:34/6=1 and the Local Passthru Queue is full (20H).

## Using RSLinx Classic, version 2.50 and higher, with SLC 5/04 Passthru

RSLinx Classic, version 2.42 and below, only supports DF1 Full-duplex to DH+, DF1 Half-duplex Master to DH+, DH-485 to DH+, DH+ to DF1 Full-duplex, and DH+ to DH-485 passthru. RSLinx Classic, version 2.43 supports all modes of channel-to-channel passthru described below, except when channel 0 control line handshaking is enabled. RSLinx Classic, version 2.50 and higher supports all modes of channel-to-channel passthru as described below.

When channel 0 is configured for DF1 Full-duplex and S:34/5=1, the SLC 5/04 passthru processor can be used by RSLinx to go online through channel 0 to the channel 1 DH+ network. The RSLinx RS-232 DF1 driver is used, with the device configured for 1770-KF2/1785-KE. The passthru processor will appear on the RSWho browse at its DH+ node address. You should configure the properties of the DH+ network within RSWho to only browse the specific range of addresses that are being utilized on the DH+ network.

When channel 0 is configured for DF1 Half-duplex Master and S:34/5=1, the SLC 5/04 passthru processor can be used by RSLinx to go online through channel 0 to the channel 1 DH+ network. The RSLinx DF1 Slave driver is used. The SLC 5/04 passthru processor channel 0 configuration must be set up in Standard Polling Mode, and the slave address of RSLinx must be included in the polling range. The DF1 Slave driver properties in RSWho must be modified to poll for the valid 5/04 DF1 Half-duplex Master passthru range of addresses, which is 128 to 191 (for DH+ nodes 0 to 77 octal or 0 to 63 decimal). The passthru processor will appear on the RSWho browse at 128 plus its decimal DH+ node address. You should configure the properties of the DH+ network within RSWho to only browse the specific range of addresses that are being utilized on the DH+ network.

When channel 0 is configured for DH-485 and S:34/0=0, the SLC 5/04 passthru processor can be used by RSLinx to go online through channel 0 to the channel 1 DH+ network, when the PC running RSLinx is directly connected to the DH-485 network through a 1784-KTX(D), -PKTX(D), or -PCMK card. When RSWho is browsing the SLC 5/04 on DH-485 with S:34/0=0, then a '+' sign will appear to the left of the SLC 5/04 icon. Clicking on the '+' sign will expose a DH+ network underneath the SLC 5/04 icon. Clicking on the '+' sign to the left of the DH+ network will result in RSWho browsing for nodes 0 to 77 (octal) on the DH+ network. You should configure the properties of the DH+ network within RSWho to browse the specific range of addresses that are being utilized on the DH+ network.

When channel 0 is configured for either DF1 Full-duplex, DF1 Half-Duplex Master, DF1 Radio Modem (with S:34/5=1), or DH-485 (with S:34/0=0), the SLC 5/04 passthru processor can be used by RSLinx to go online through channel 1 to the channel 0 DF1 or DH-485 network, as long as the PC running RSLinx is directly connected to the DH+ network through a

1784-KT, -KTX(D), -PKTX(D), or -PCMK card. When RSWho is browsing the SLC 5/04 on DH+, and channel 0 is either configured for DH-485 with S:34/0=0 or for DF1 with S:34/5=1, then a '+' sign will appear to the left of the SLC 5/04 icon. Clicking on the '+' sign will expose a DH-485 or DF1 network underneath the SLC 5/04 icon. Clicking on the '+' sign to the left of the DH-485 or DF1 network will result in RSWho browsing for nodes 0-31 on the DH-485 network or for node 1 on the DF1 network.

Refer to the steps on page 14-13 for browsing multiple nodes when channel 0 is configured for DF1 Half-duplex Master or DF1 Radio Modem.

## Creating and Filling out the Passthru Routing Table File

The SLC 5/05 processor uses a routing table to cross-reference the one-byte addressing used by DF1 and DH-485 protocols with the four-byte IP address needed to support Ethernet communication. The routing table is stored in a user-selectable integer Data File and uses two word elements of the integer file to store one IP address.

The Routing Table data file is defined in the Chan. 1 – System menu under Channel Configurations.

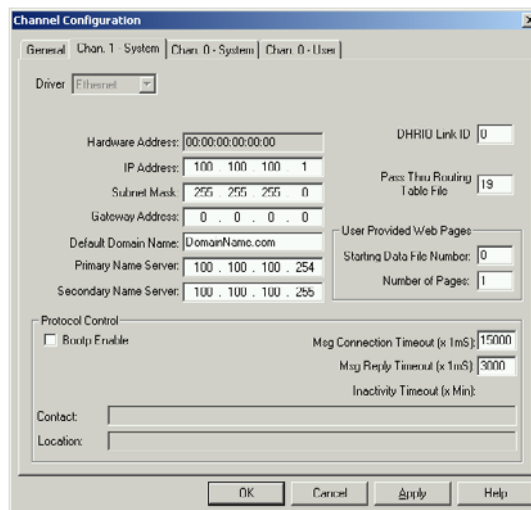

The routing table file number must be between 9 and 255 (a valid data table address). A value of zero will disable the routing table and disable passthru functionality. The routing table file must be at least two words in length.

Access to the passthru routing table is located under the channel configuration selection in RSLogix 500 Programming Software. If a Passthru Routing Table File number was entered in the General Tab in the Channel Configuration dialog box, click on the + in front of Channel Configuration to reveal the routing table selection.

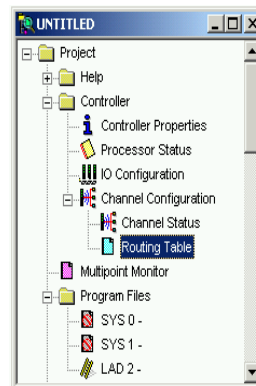

Double-click on Routing Table to view and modify the passthru routing table.

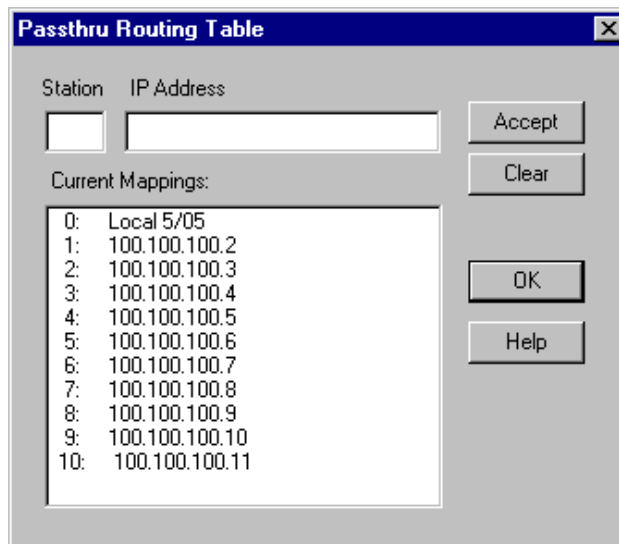

**IMPORTANT**

All Ethernet devices that information needs to be passed to or from, must have their IP Address listed in the Passthru Routing Table.



**IMPORTANT**

Only Ethernet devices that support Client Server Protocol (CSP), such as SLC 5/05 processors, PLC-5 processors, PLC-5 Ethernet sidecars (1785-ENET), and RSLinx software, can use SLC 5/05 passthru. Passthru does not work with Ethernet devices supporting only EtherNet/IP protocol.

## Using RSLinx Classic, version 2.50 and higher, with SLC 5/05 Passthru

RSLinx Classic, version 2.42 and below, only supports DF1 Full-duplex to Ethernet, DF1 Half-duplex Master to Ethernet, DH-485 to Ethernet, Ethernet to DF1 Full-duplex, and Ethernet to DH-485 passthru. RSLinx Classic, version 2.43 supports all modes of channel-to-channel passthru described below, except when channel 0 control line handshaking is enabled. RSLinx Classic, version 2.50 and higher supports all modes of channel-to-channel passthru as described below.

When channel 0 is configured for DF1 Full-duplex and S:34/5=1, the SLC 5/05 passthru processor can be used by RSLinx to go online through channel 0 to the channel 1 Ethernet network. Each Ethernet device that RSLinx browses uses up an outgoing SLC 5/05 connection. See Table 12.3 to determine how many available outgoing connections the SLC 5/05 has available. The RSLinx RS-232 DF1 driver is used, with Device configured for either 1770-KF3/1747-KE, which allows browsing of Ethernet devices from a block of entries within the range of 1 to 31 in the Passthru Routing Table, or for 1770-KF2/1785-KE, which allows browsing of Ethernet devices from a block of entries within the range of 1 to 77 octal (1 to 63 decimal). The size of the block of entries must not exceed the number of available outgoing connections. The passthru processor will show up on the RSWho browse at node 0. You should configure the properties of the DF1 network within RSWho to browse the specific range of addresses that are being used in the passthru routing table.

When channel 0 is configured for DF1 Half-duplex Master and S:34/5=1, the SLC 5/05 passthru processor can be used by RSLinx to go online through channel 0 to the channel 1 Ethernet network. The RSLinx DF1 Slave driver is used. The SLC 5/05 passthru processor channel 0 configuration must be set up in Standard Polling Mode, and the slave address of RSLinx must be included in the polling range. The DF1 Slave driver properties in RSWho must be modified to poll for a block of entries within the range of 129 to 254 (the valid 5/05 passthru range of addresses, which is 128 plus the Passthru Routing Table entry numbers of 1 to 126). The size of the block of entries must not

exceed the number of available outgoing connections. The passthru processor will show up on the RSWho browse at node 128.

When channel 0 is configured for DH-485 and S:34/0=0, the SLC 5/05 passthru processor can be used by RSLinx to go online through channel 0 to the channel 1 Ethernet network, as long as the PC running RSLinx is directly connected to the DH-485 network through a 1784-KTX(D), -PKTX(D), or –PCMK card. When RSWho is browsing the SLC 5/05 on DH-485 with S:34/0=0, then a '+' sign will appear to the left of the SLC 5/05 icon. Clicking on the '+' sign will expose an Ethernet network underneath the SLC 5/05 icon. The Ethernet network properties in RSWho must be modified to poll for a block of entries within the range of 129 to 254 (the valid 5/05 passthru range of addresses, which is 128 plus the Passthru Routing Table entry numbers of 1 to 126). The size of the block of entries must not exceed the number of available outgoing connections. Clicking on the '+' sign to the left of the Ethernet network will result in RSWho browsing for those nodes on the Ethernet network.

When channel 0 is configured for either DF1 Full-duplex, DF1 Half-Duplex Master, DF1 Radio Modem (with S:34/5=1) or DH-485 (with S:34/0=0), the SLC 5/05 passthru processor can be used by RSLinx to go online through channel 1 to the channel 0 DF1 or DH-485 network, as long as the PC running RSLinx is directly connected to the Ethernet network. The PC's IP address must be present in the Passthru Routing Table for RSLinx Ethernet to channel 0 passthru to work. When RSWho is browsing the SLC 5/05 on Ethernet with the AB\_ETH driver, and channel 0 is either configured for DH-485 with S:34/0=0 or for DF1 with S:34/5=1, then a '+' sign will appear to the left of the SLC 5/05 icon. Clicking on the '+' sign will expose a DH-485 or DF1 network underneath the SLC 5/05 icon. Clicking on the '+' sign to the left of the DH-485 or DF1 network will result in RSWho browsing for nodes 0 to 31 on the DH-485 network or for node 1 on the DF1 network.

Refer to the steps on page 14-13 for browsing multiple nodes when channel 0 is configured for DF1 Half-duplex Master or DF1 Radio Modem.

## SLC 5/05 Passthru Error Codes

A SLC 5/05 passthru processor may respond to a MSG instruction or RSLinx with an error code of 20H under the following conditions.

- The routing table integer file number is out of range (9 to 255).
- The routing table file does not exist in the user program directory or is less than 2 word elements in length.
- The IP address entry in the routing table does not exist.
- Lack of available connections.

## Optimizing RSLinx Channel 1 to DF1 Half-duplex Master/DF1 Radio Modem Passthru

Use the following procedure to get RSWho to browse from channel 1 through the SLC 5/03, 5/04, and 5/05 processors when either the DF1 Half-duplex Master or DF1 Radio Modem channel 0 driver is configured.

1. If using a SLC 5/05 as the passthru processor, be sure to configure the IP address of the PC running RSLinx/RSWho into the SLC 5/05 Passthru Routing Table.
2. Make sure that the DF1 passthru enable bit (S:34/5) is set in the passthru processor.
3. Configure the appropriate RSLinx driver to communicate via DH-485 with an SLC 5/03 passthru processor, via DH+ with an SLC 5/04 passthru processor or via Ethernet with an SLC 5/05 passthru processor.

**TIP**

RSLinx must be directly connected on the same network (DH-485, DH+, or Ethernet) as the passthru processor for passthru to work.

- When you run RSWho on that passthru processor network, the SLC 5/03, 5/04, or 5/05 passthru processor should appear with a '+' sign to the left of its icon as shown below:

**Figure 14.1 SLC 5/04 Passthru Processor on RSWho**

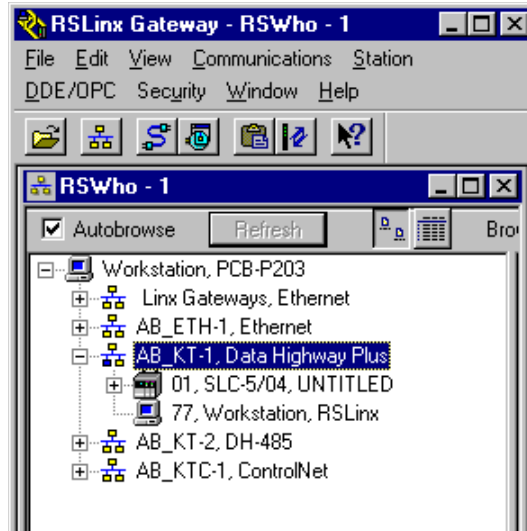

- Click on the '+' sign and verify that a Channel 0, DF1 network appears below the SLC 5/04 (or SLC 5/03 or 5/05), as shown below:

**Figure 14.2 Channel 0, DF1 Network**

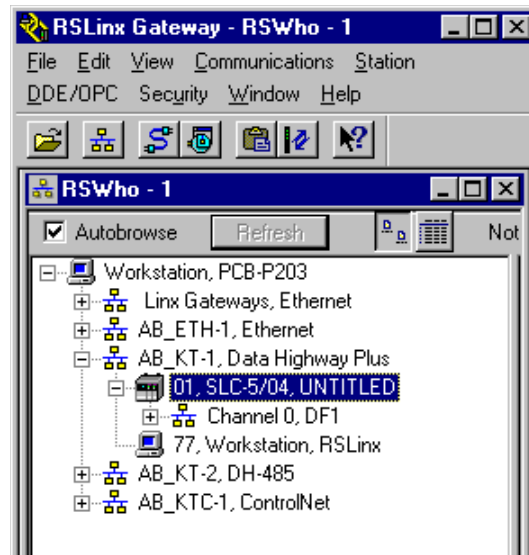

Before browsing this Channel 0 DF1 network, you should configure RSWho to only browse the range of remote node addresses that you expect to find. You should also limit RSWho to browse only one node at a time. To accomplish this, right click on the Shortcut DF1 network and select properties.

6. Check Browse only the specified addresses: and specify the low and high addresses of the range to be browsed:

**Figure 14.3 Configuring RSWho Browse Addresses**

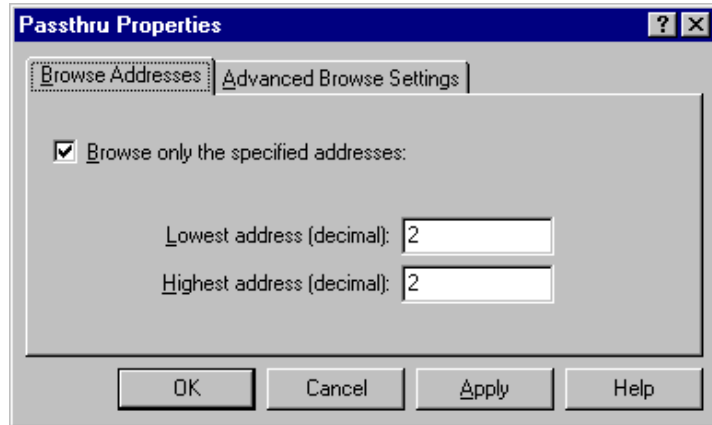

7. Click on the Advanced Browse Settings tab, check the Use custom browse settings box and enter 1 for the Maximum concurrent packets to this network:

**Figure 14.4 Advanced RSWho Browse Settings**

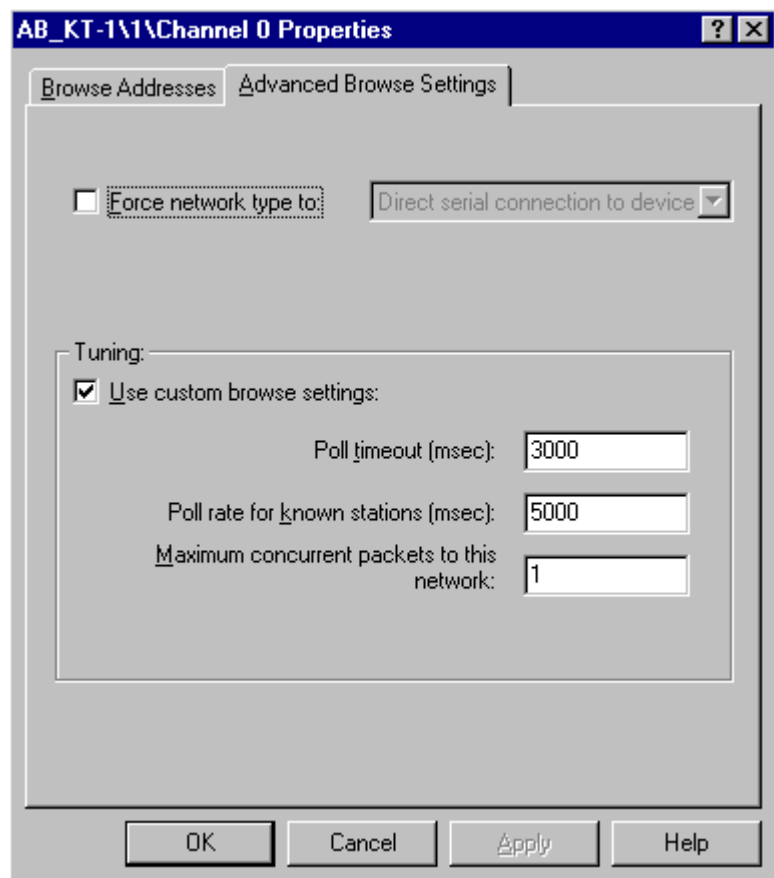

If channel 0 is configured for DF1 Half-duplex Master, then the RSWho Poll Timeout should be set to:

$$\text{Channel 0 ACK Timeout} * [1 + (2 * \text{channel 0 message retries})]$$

If channel 0 of an SLC 5/05 is configured for DF1 Radio Modem, then the RSWho Poll Timeout should be set the same as the Ethernet channel 1 MSG Reply Timeout.

The RSWho Poll Timeout for known stations should be set to the time it takes to poll the entire range of addresses.

Click OK and close RSWho (but you can leave RSLinx running). Start RSWho again and now you should be able to browse through the passthru processor to any remote nodes in the configured address range that are able to respond on the half-duplex or radio modem network.

**TIP**

Your passthru processor will show up as remote node 0 when using RSWho, as shown below. Therefore, it is a good idea to configure the channel 0 node address of the passthru processor as zero.

**Figure 14.5 Passthru Processor in RSWho**

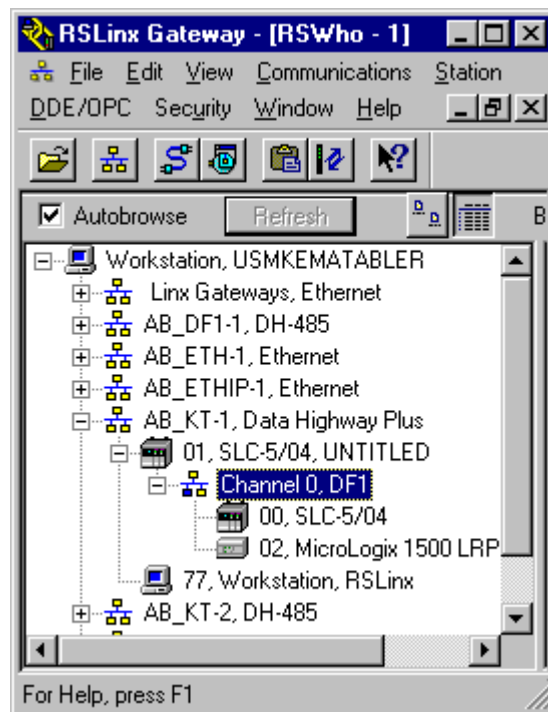

## Messaging Examples

The purpose of this chapter is to illustrate some of the more common but elaborate messaging examples using the SLC 500 processors.

Not all examples will appear with a full detailed step by step procedure necessary.

Step by Step procedures are available for all of the examples in KnowledgeBase Documents at the following website:

<http://support.rockwellautomation.com/knowledgebase>

Search for the associated Knowledge Base Document Number referenced after the associated example.

It may be necessary to register and obtain a username and password if accessing the website for the first time or if your web browser does not have cookies enabled.

---

**IMPORTANT**

Refer to the SLC 500 Modular Hardware Style User Manual, publication 1747-UM011, for the setup of DH-485, DH+, and Ethernet networks, as well as DF1 communication.

---

### Local versus Remote type Message

#### Local Message

A Local MSG is used to transmit data from one processor to another on the same network. If two processors are connected together a Local type message is used to transfer information from one to the other.

#### Remote Message

A Remote MSG is used to exchange information to a device that is not connected on the local network. A device (another processor or an actual bridging device) on the local network will act as a bridge or gateway to the destination network.

---

**IMPORTANT**

In a multi-network environment, each network must have a unique Link ID (Pass Thru Link ID) for help in obtaining acceptable results.

---

## Remote Terminology

### Remote Bridge Address

Remote Bridge Address is the remote node address of the bridge device used to connect two networks together.

**TIP**

SLC Fixed Processors, SLC 5/01 and SLC 5/02 are all non-remote MSG capable processors. When issuing a remote message and the target device is non-remote capable, a remote bridge address is needed.

### Remote Station Address

Remote Station Address is the final destination address of a remote MSG instruction.

### Remote Bridge Link ID

Remote Bridge Link ID is a user assigned address that differentiates same type networks from each other when multiple networks are connected together. Passthru Link ID's are required when initiating a Remote MSG.

All processors on a particular network need to have all the Passthru Link ID's set to the same address. Valid Link ID addresses are from 1 to 65,534. Note: SLC processors can only initiate to remote networks with Link IDs in the range of 1 to 254.

**TIP**

Make sure that all processors on the same network share the same Link ID.



**TIP**

Link ID's are modified in each processor's Channel Configuration properties.

The default Passthru Link ID for the SLC 5/03, 5/04 and 5/05 processors channel 0 port is 1.

The default Passthru Link ID for the SLC 5/03, 5/04 and 5/05 processors channel 1 port is 2.

Refer to Chapter 14 for more information regarding passthru.

## SLC 5/03 Passthru Examples

### Passthru Example: DF1 to DH-485

The following illustrates a SLC 5/03 processor as a passthru processor. The SLC 5/03 processor will forward messages received on the DF1 network (channel 0) to the DH-485 network (channel 1). For this example, the SLC 5/03's configuration bits are set to the following values.

- DF1 Pass-Thru Enable bit (S2:34/5) is set
- DH-485 Pass-Thru Disable bit (S2:34/0) is set
- DF1 Remote/Local Pass-Thru (S2:34/6) is clear

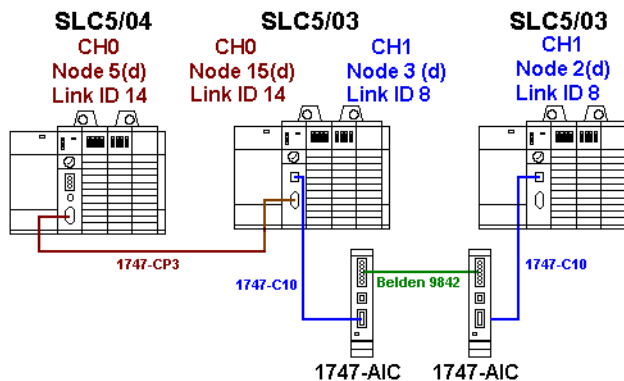

The DF1 Pass-Thru Enable Bit (S2:34/5) enables messages to be passed to and from the channel 0 DF1 network from and to the channel 1 DH-485 network. This bit must be set to enable DH-485-to-DF1 passthru.

The DF1 Remote/Local Pass-Thru bit (S2:34/6) is cleared in order to send messages to the channel 1 DH-485 network as remote DH-485 packets. This is the default setting for this bit. The DF1 Remote/Local Pass-Thru bit (S2:34/6) is needed when non-remote capable devices exist on the channel 1 DH-485 network, such as SLC 500 Fixed, SLC 5/01, SLC 5/02, ControlLogix, FlexLogix, and CompactLogix controllers. The DF1 Remote/Local Pass-Thru bit (S2:34/6) should be set for passthru messaging to these controllers.

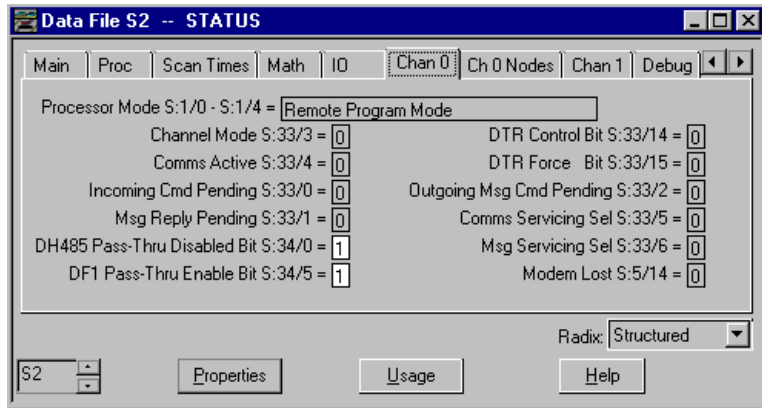

RSLogix500 V 6.10.10 and earlier do not reference S2:34/6 in structured display formats. In order to alter this bit, change the RADIX from structured to binary.

**TIP**

No programming logic is necessary in the passthru processor.

The following is the ladder logic necessary for the SLC 5/04 processor.

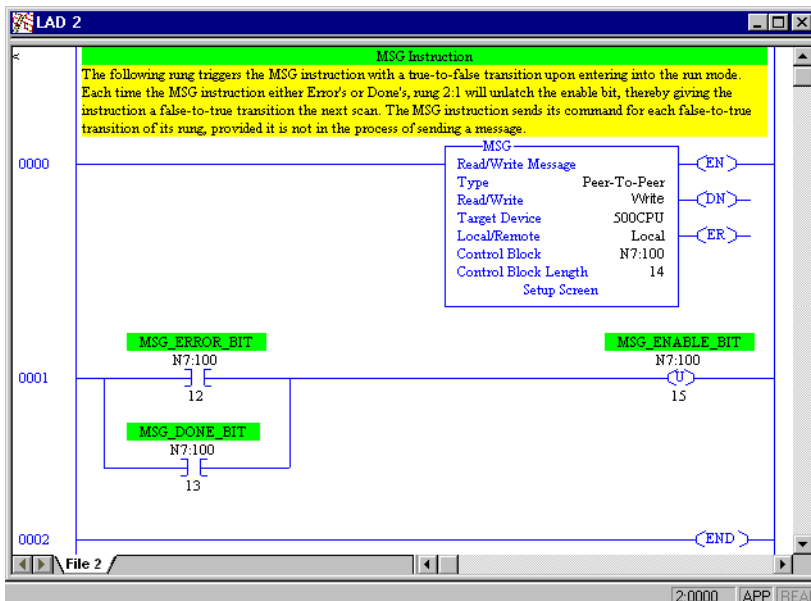

The following is the MSG setup for the SLC 5/04 processor.

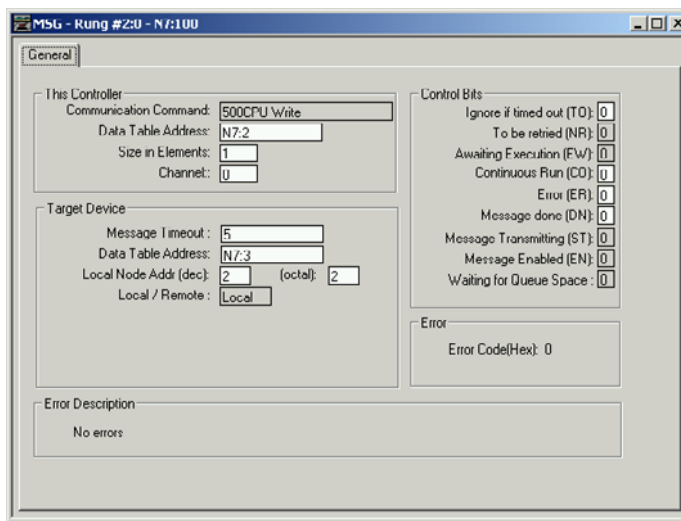

The type of MSG instruction is Local. The local node address is the node number of the destination DH-485 address.

For the step by step procedure for this example, refer to Knowledgebase Document Number: G63635969.

### Passthru Example: DH-485 to DF1

The following illustrates a SLC 5/03 processor as a passthru processor that receives remote messages targeting the SLC 5/04 on the DF1 network. The SLC 5/03 processor will forward remote messages received on the DH-485 network (channel 1) to the DF1 network (channel 0) as local messages. For this example, the SLC 5/03's configuration bits are set to the following values.

- DF1 Pass-Thru Enable bit (S2:34/5) is set
- DH-485 Pass-Thru Disable bit (S2:34/0) is set

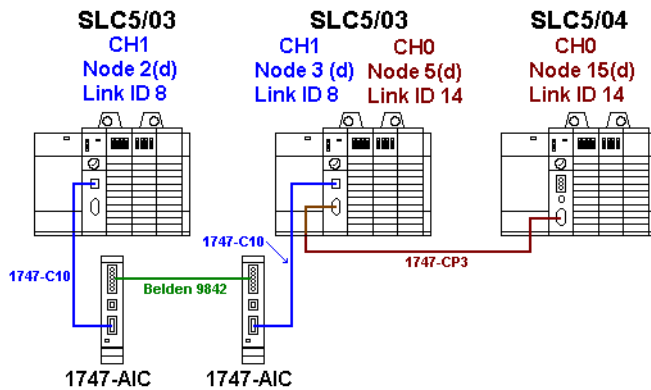

The DF1 Pass-Thru Enable Bit (S2:34/5) enables messages to be passed to and from the channel 0 DF1 network from and to the channel 1 DH-485 network. This bit must be set to enable DH-485-to-DF1 passthru.

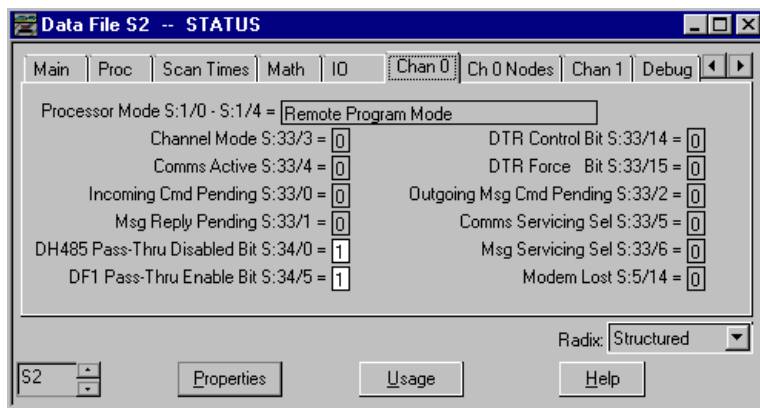

**TIP**

No programming logic is necessary in the passthru processor.

The following is the ladder logic necessary for the SLC 5/03 processor (node 2).

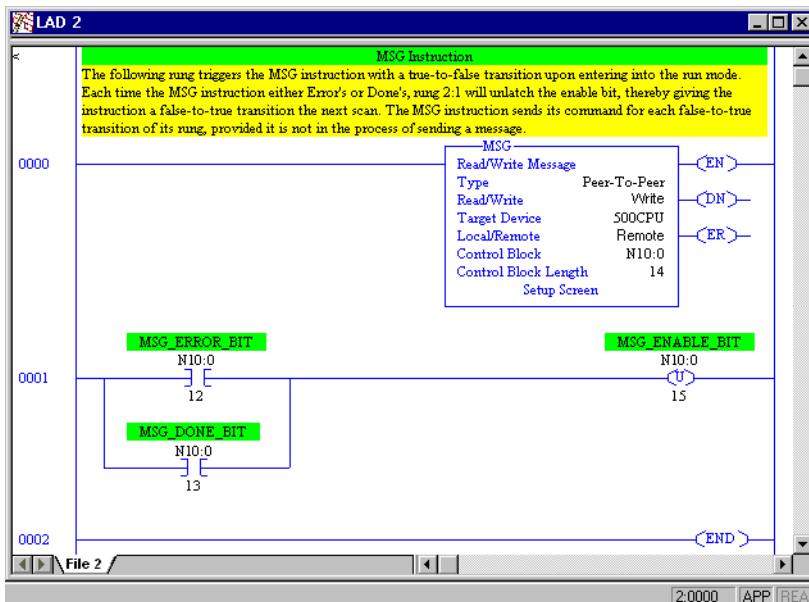

The following is the MSG Setup for the SLC 5/03 processor (node 2).

The screenshot shows the 'MSG - N10:0 : (14 Elements)' configuration dialog box. The 'General' tab is selected. Under 'This Controller', the Communication Command is '500CPU Write', Data Table Address is 'N7:0', Size in Elements is '10', and Channel is '1'. Under 'Target Device', the Message Timeout is '5', Data Table Address is 'N7:100', Local Bridge Addr (dec) is '3' (octal: '3'), Local / Remote is 'Remote', Remote Bridge Addr (dec) is '0', Remote Station Address (dec) is '0', and Remote Bridge Link ID is '14'. The 'Control Bits' section includes: Ignore if timed out (TO): 0, To be retried (NR): 0, Awaiting Execution (EW): 0, Continuous Run (CD): 0, Error (ER): 0, Message done (DN): 0, Message Transmitting (ST): 1, Message Enabled (EN): 1, and Waiting for Queue Space: 0. The 'Error' section shows Error Code(Hex): 0. The 'Error Description' field contains 'No errors'.

The type of MSG instruction is Remote.

Local Bridge Address is the node number of the passthru DH-485 processor.

Remote Bridge Address is not required.

Remote Station Address is the node number of the target processor. A DF1 Full-duplex target device does not require a Remote Station Address.

Remote Bridge Link ID is the Link ID number of the DF1 destination network.

For the step by step procedure for this example, refer to Knowledgebase Document Number: G63059559.

### Passthru Example: DH-485 to DH-485

The following illustrates a SLC 5/03 processor as a passthru processor when both channel's networks are configured for DH-485. The SLC 5/03 processor will forward remote messages received on the DH-485 network (channel 1) to the DH-485 network (channel 0) as remote messages. For this example, the SLC 5/03's configuration bits are set to the following values.

- DF1 Pass-Thru Enable bit (S2:34/5) is clear
- DH-485 Pass-Thru Disable bit (S2:34/0) is clear

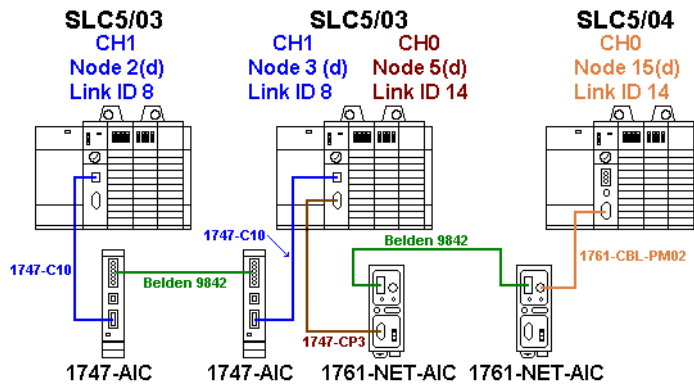

The DH-485 Pass-Thru Disabled Bit (S2:34/0) enables messages to be passed to and from the channel 1 DH-485 network from and to the channel 1 DH-485 network. This bit must be cleared to enable DH-485-to-DH-485 passthru.

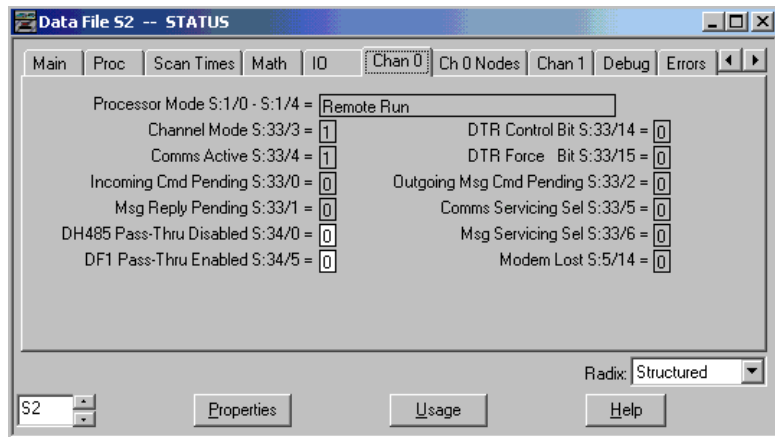

**TIP**

No programming logic is necessary in the passthru processor.

The following is the ladder logic necessary for the SLC 5/03 processor (node 2).

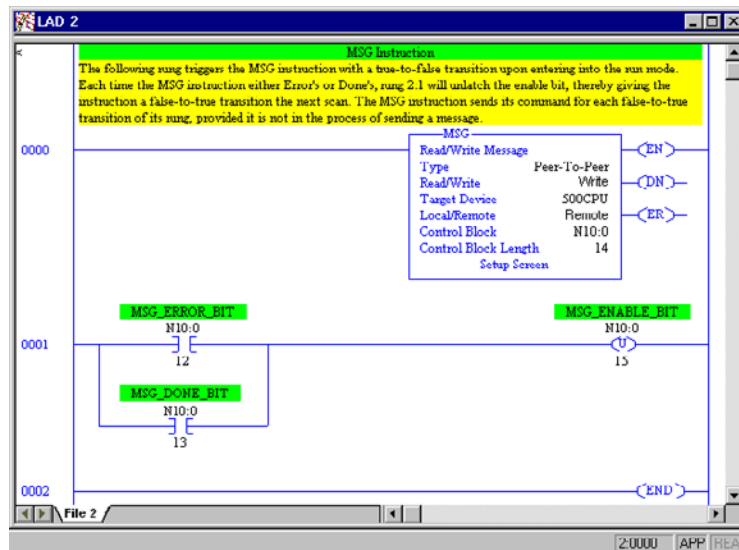

The following is the MSG Setup for the SLC 5/03 processor (node 2).

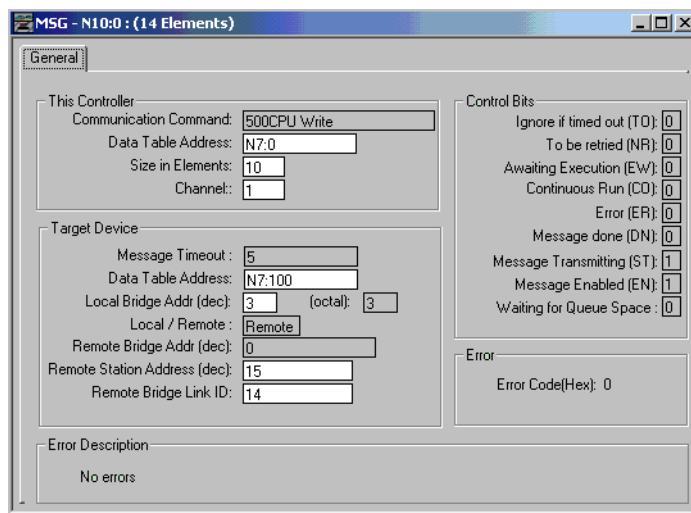

The type of MSG instruction is Remote.



Local Bridge Address is the node number of the passthru DH-485 processor.

Remote Bridge Address is not required if the target device is remote capable.

Remote Station Address is the node number of the target processor.

Remote Bridge Link ID is the Link ID number of the destination network.

The SLC 5/04 processor (node 15) is also capable of messaging to the SLC 5/03 (node 2). The following MSG setup information would be required in the SLC 5/04 MSG instruction.

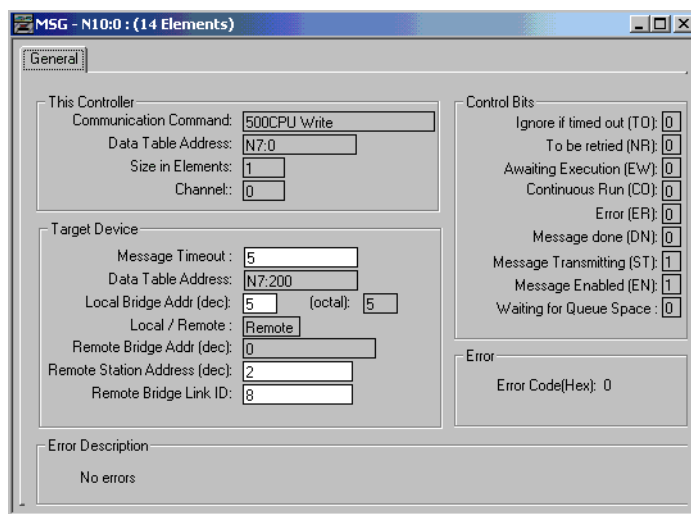

For the step by step procedure for this example, refer to Knowledgebase Document Number: G62931042.

## SLC 5/04 Passthru Examples

### Passthru Example: DF1 to DH+

The following illustrates a SLC5/03 sending a local message via DF1 (CH0) to a SLC5/04 processor. The SLC5/04 processor that receives the initial message will send the message out DH+ to the SLC5/04 processor whose address matches the Local Bridge Address on the DH+ network as long as DF1 Passthru is enabled.

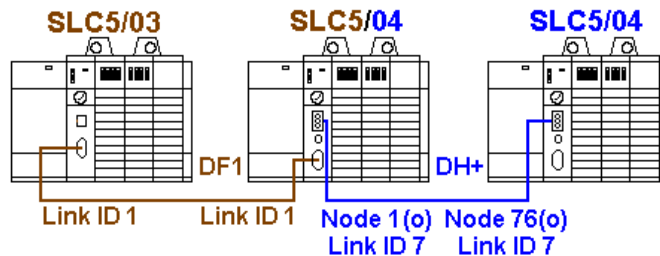

1747-CP3 cable is used to connect the SLC5/03 CH0 port to the SLC5/04 CH0 port.

Status File Bit (S:34/5) must be set in the passthru processor in order to enable the DF1-to-DH+ Passthru.

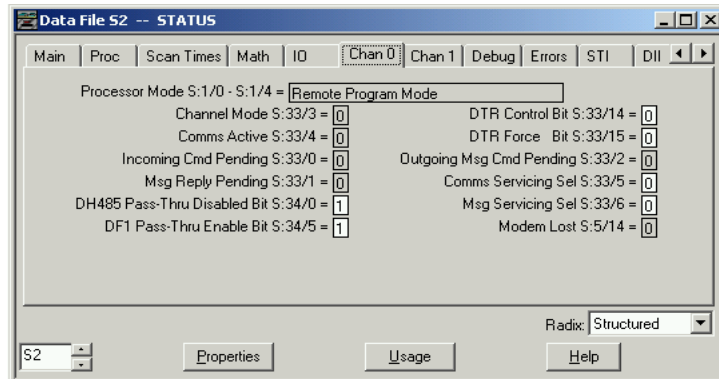

**TIP**

No programming logic is necessary in the passthru processor.

The following is the ladder logic necessary for the SLC5/03 processor.

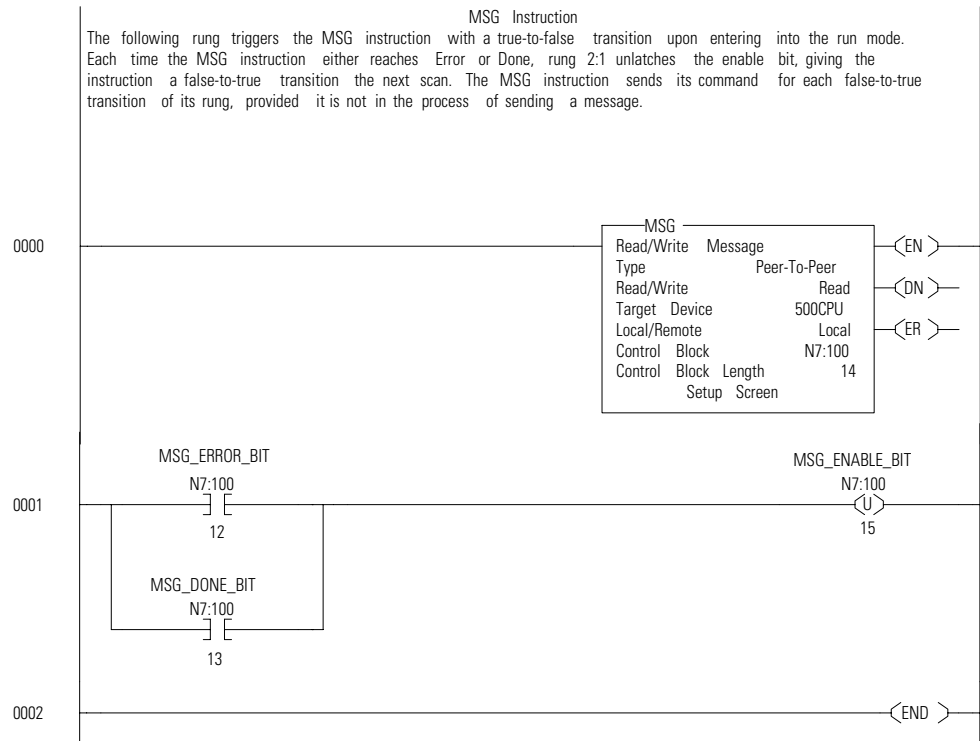

The following is the MSG Setup for the SLC5/03 processor.

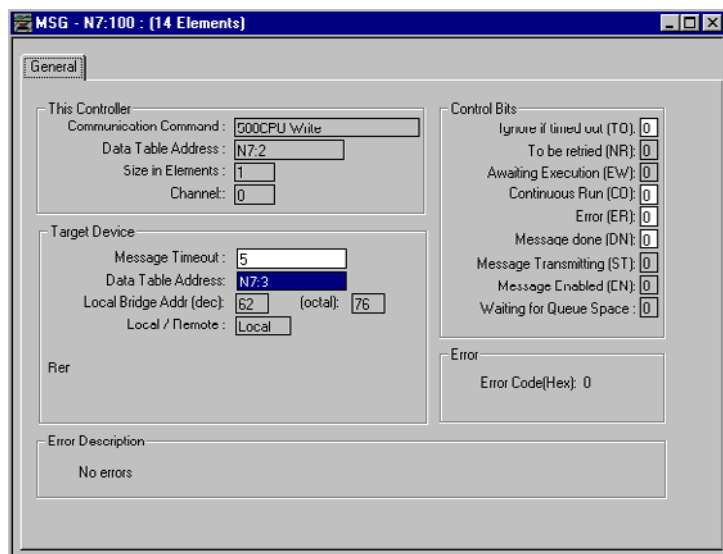

Local Bridge Address is the node number of the destination DH+ address.

The type of MSG instruction is Local.

The following is the Channel Configuration MSG Setup for the SLC5/03 processor.

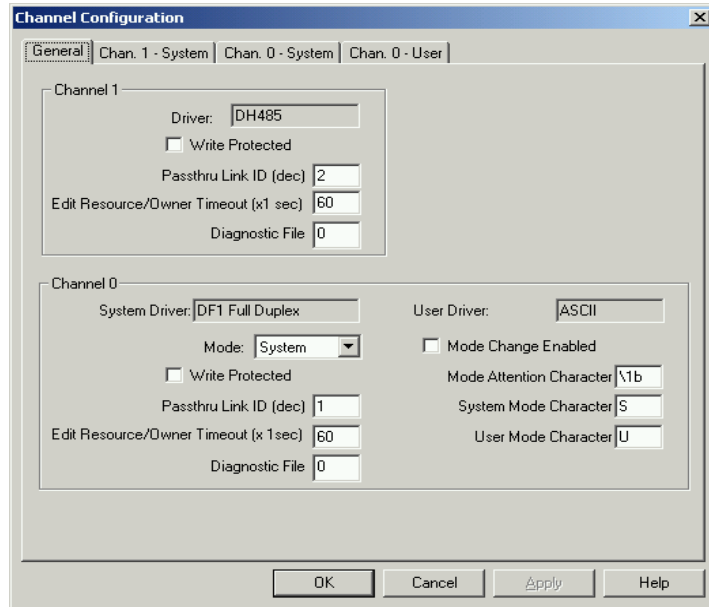

Channel 0 Mode is set for System.

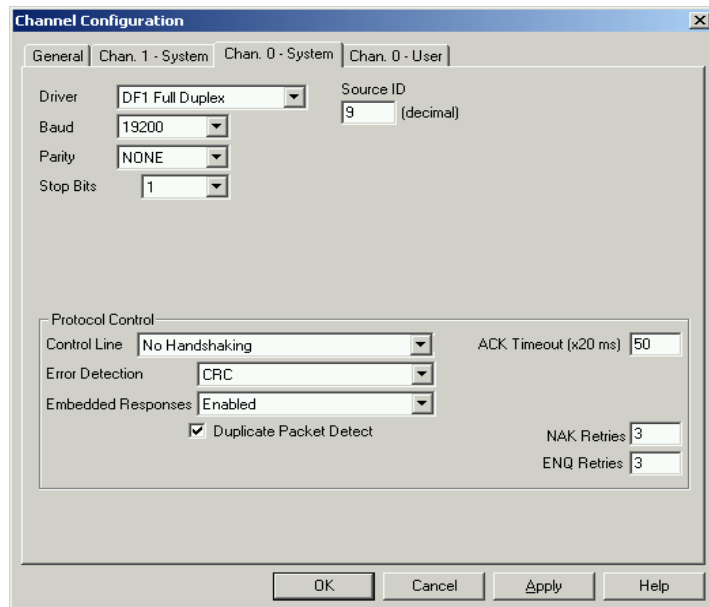

Chan. 0 - System driver is set for DF1 Full Duplex.

For the step by step procedure for this example, refer to Knowledgebase Document Number: G20023.

## Passthru Example: DH+ to DF1

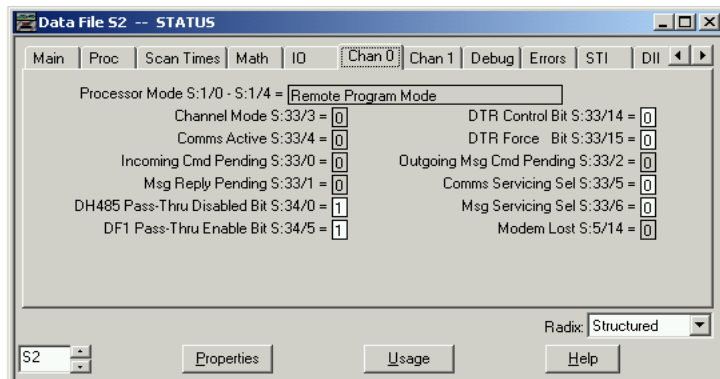
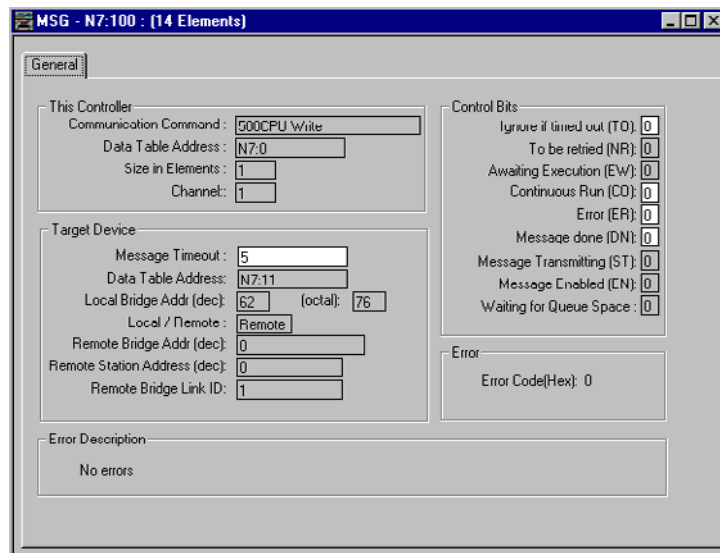
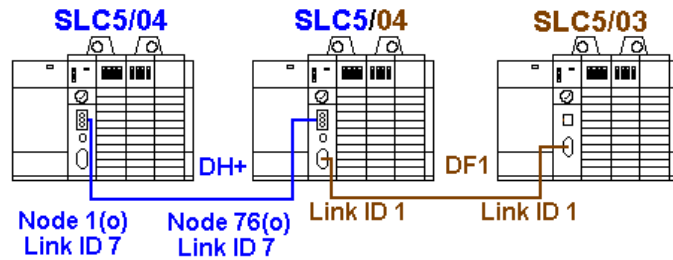

For the Step by Step procedure for this example refer to Knowledgebase Document Number: G20024.

### Passthru Example: DH-485 to DH+

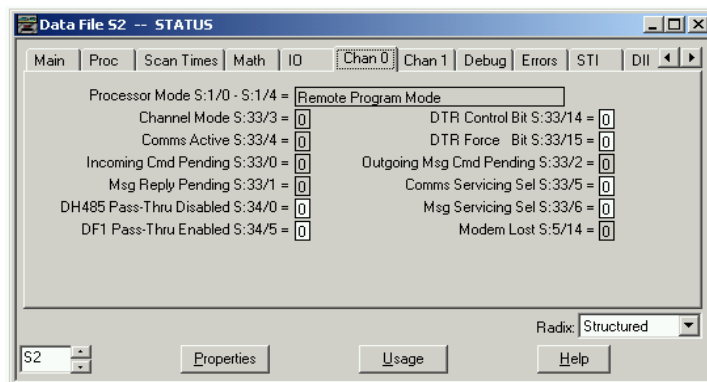
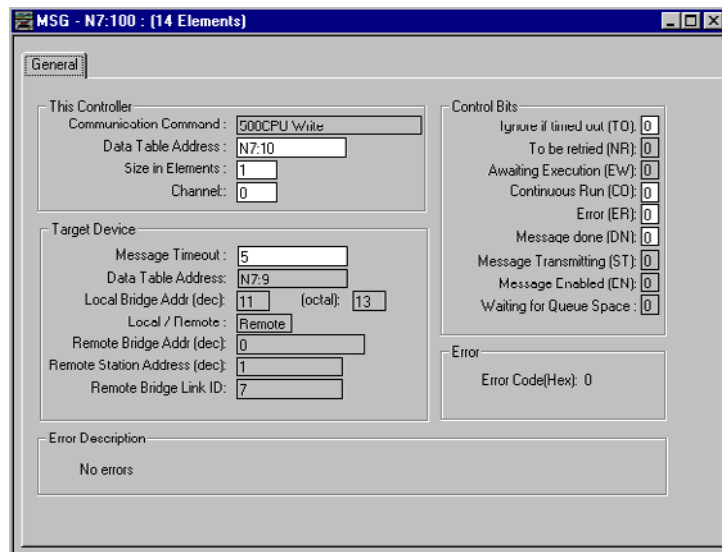
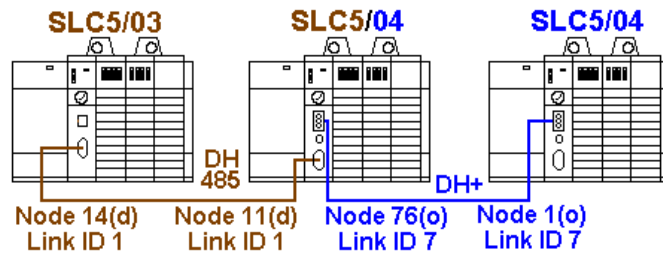

For the Step by Step procedure for this example refer to Knowledgebase Document Number: G20025.

### Passthru Example: DH+ to DH-485

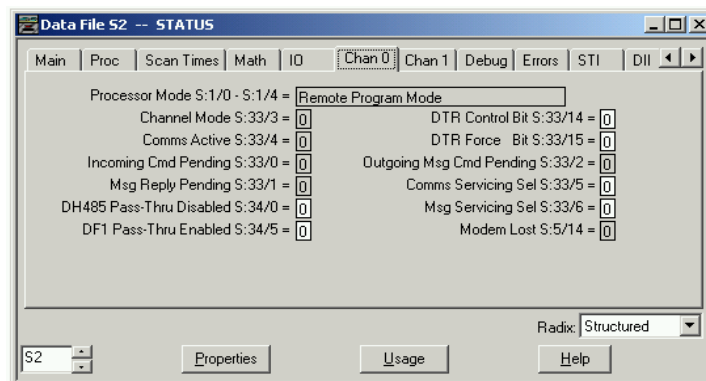
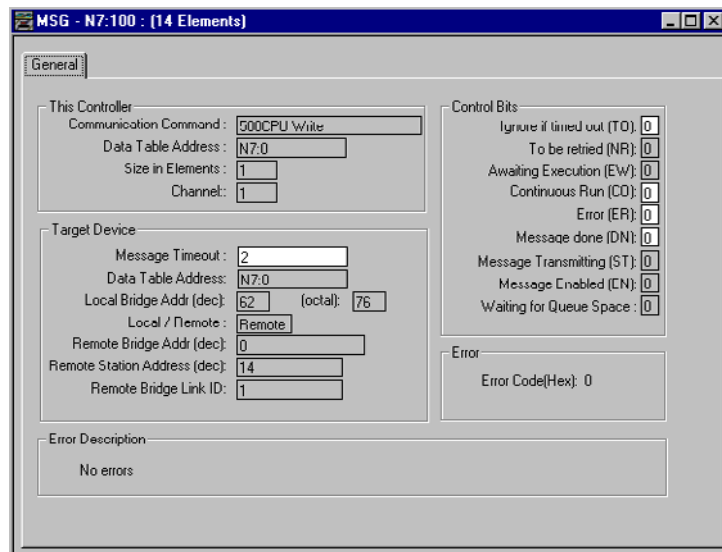
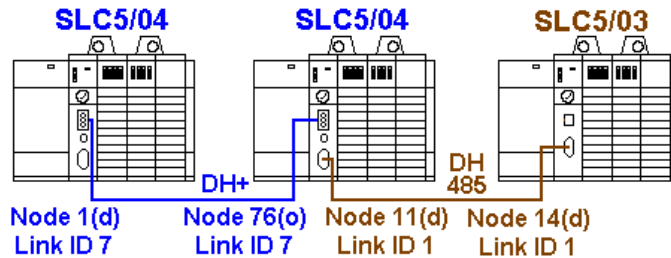

For the Step by Step procedure for this example refer to Knowledgebase Document Number: G20026.

## SLC 5/05 Passthru Examples

### Passthru Example: DF1 to Ethernet

The IP Addresses used in the following illustration are for example purposes only. Contact your system administrator for IP addresses unique to your network.

In the following diagram, a SLC 5/03 will send a local message via DF1 to the SLC 5/05 (IP Address 100.100.115.9). The SLC 5/05 acts as a bridge, sending the message out via Ethernet to the SLC 5/05 (IP Address 100.100.115.1), whose address is stored in the routing table.

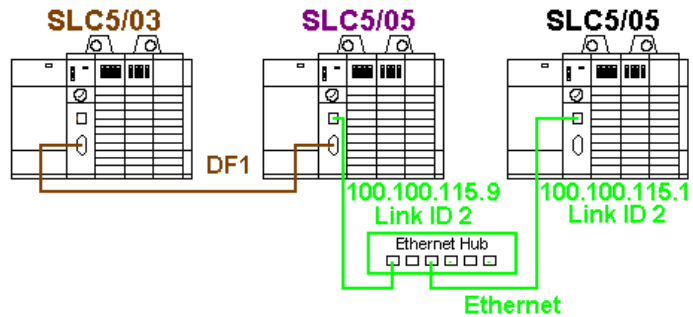

#### IMPORTANT

In the SLC 5/05 (IP Address 100.100.115.9) bridge, Status File Bit S:34/5 must be set to 1 to enable DF1-to-Ethernet passthru.

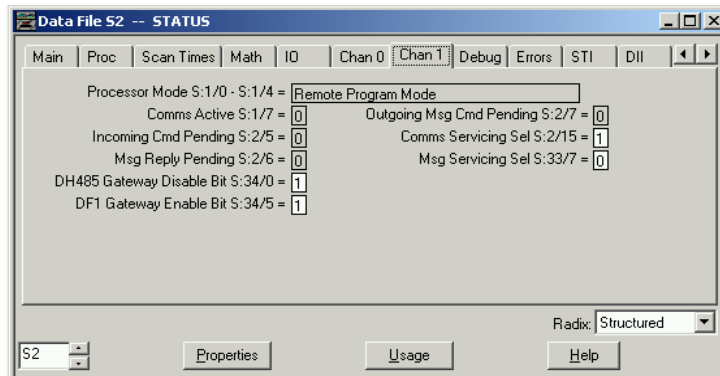



The following is the logic necessary for the SLC5/03 processor.

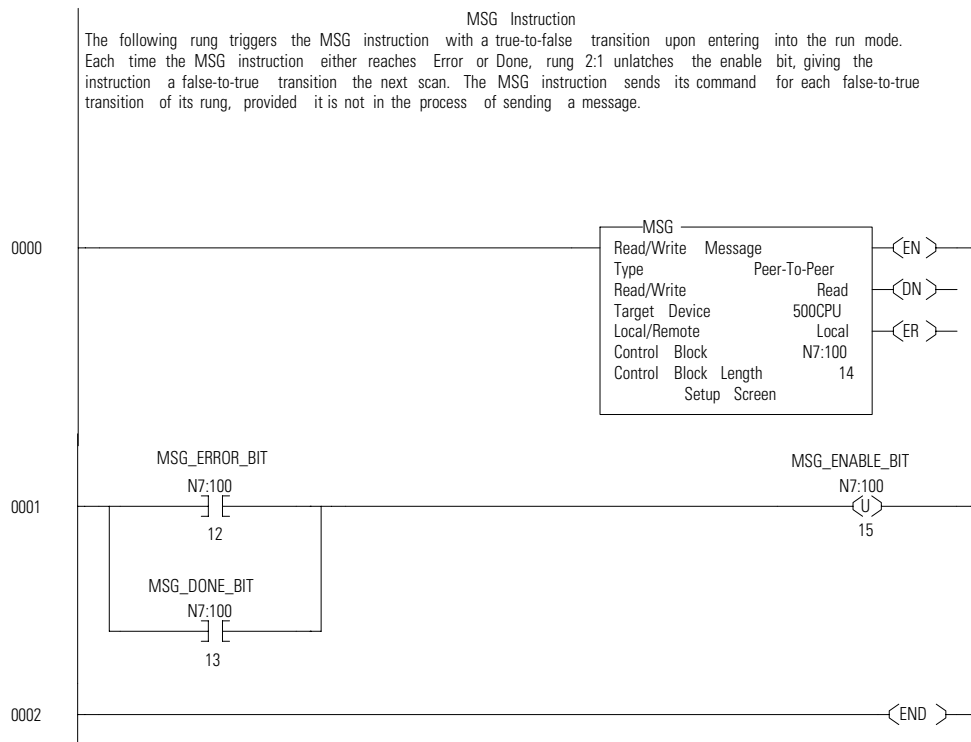

The following is the MSG Setup for the SLC5/03 processor.

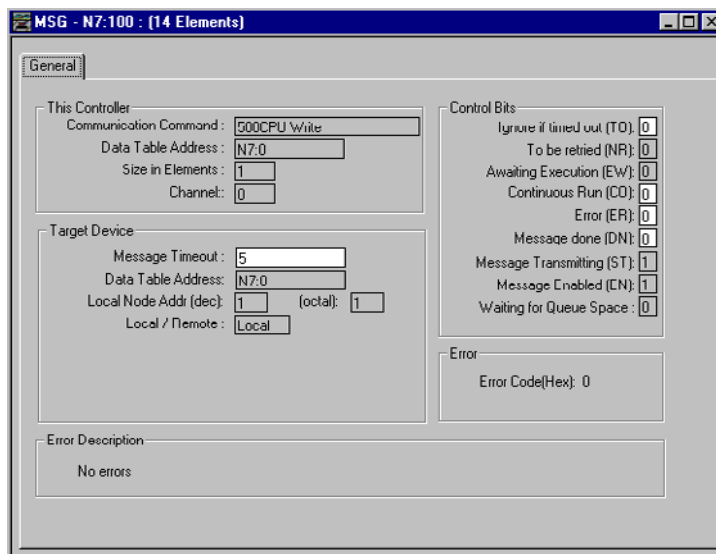

Local node address is the station address in the SLC 5/05 (IP Address 100.100.115.9) routing table where the target IP address for SLC 5/05 (IP Address 100.100.115.1) is stored.

### SLC 5/05 (IP Address 100.100.115.9) Bridge

Ladder logic is not required for the SLC 5/05 which acts as the bridge from DF1-to-Ethernet. However, you must set up a passthru routing table when configuring the bridge. The General channel configuration page is shown below, followed by the Channel 1 System configuration page with the Pass Thru Routing Table File entry.

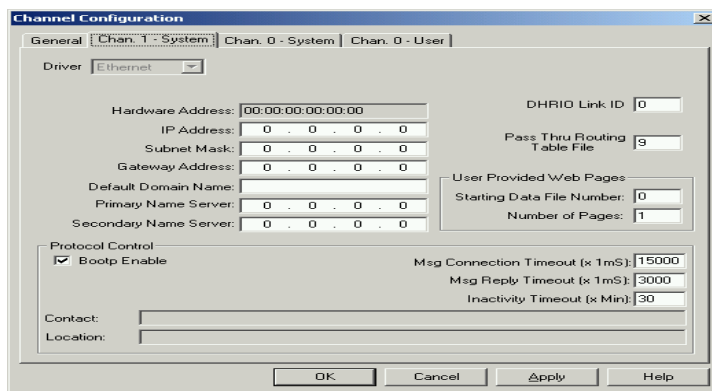
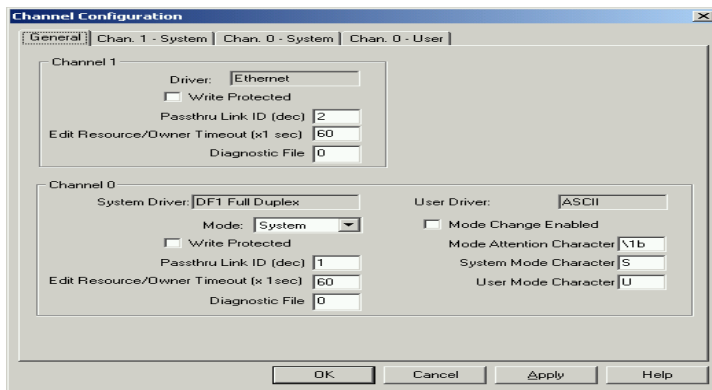

Passthru Link IDs are used by other processors to send remote MSG packets through the SLC 5/05 (IP Address 100.100.115.9) when channel-to-channel passthru is used. Passthru Link IDs must be properly specified in the remote MSG instructions to enable channel-to-channel passthru. The default Passthru Link ID for Channel 0 is one. The default Passthru Link ID for Channel 1 is two.

The Passthru Routing Table File is the integer file used by the processor to store routing table IP addresses and link them to unique node addresses.

**IMPORTANT** Channel 0 Source ID must be set to 0 when SLC 5/05 (IP Address 100.100.115.9) is used as the bridge between DF1 full-duplex and Ethernet.

### Passthru Routing Table

The passthru routing table is located under the channel configuration selection in RSLogix 500 Programming Software. If a Passthru Routing Table File number was entered in the Chan. 1 - System tab in the Channel Configuration dialog box, click on the + in front of Channel Configuration to reveal the routing table selection.

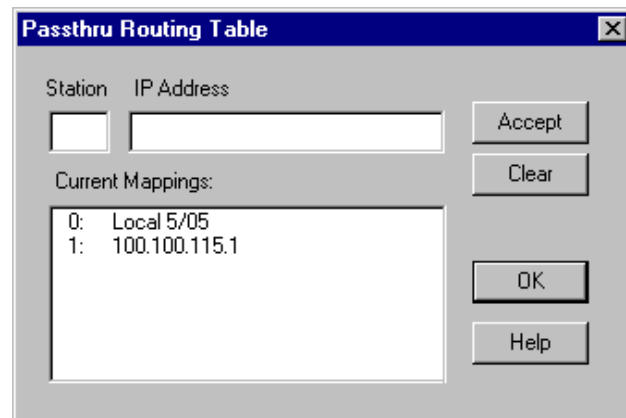

**IMPORTANT** The routing table must contain the IP address of SLC 5/05 (IP Address 100.100.115.1) at station target node one, as shown in the routing table above. Target node one was identified as the target node in the SLC 5/03 Message Setup dialog box.

For the Step by Step procedure for this example refer to Knowledgebase Document Number: G20027.

## Passthru Example: Ethernet to DF1

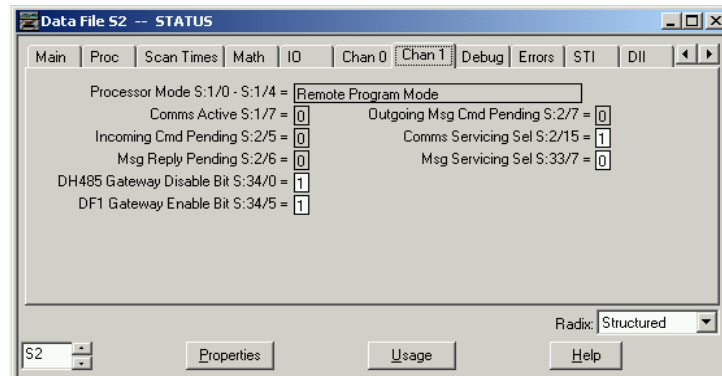
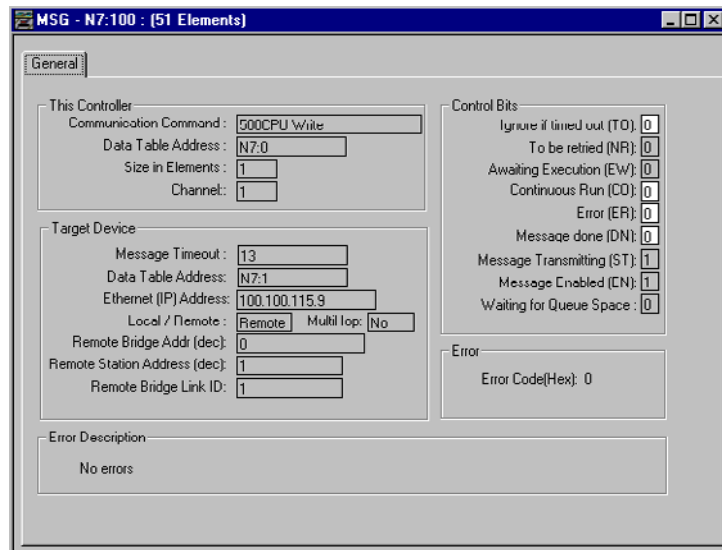
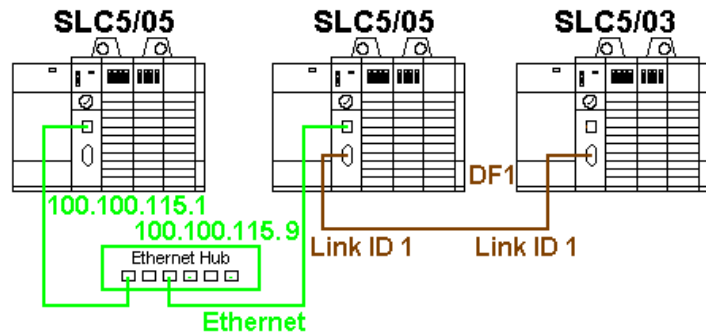

For the Step by Step procedure for this example refer to Knowledgebase Document Number: G20028.

## Passthru Example: DH-485 to Ethernet

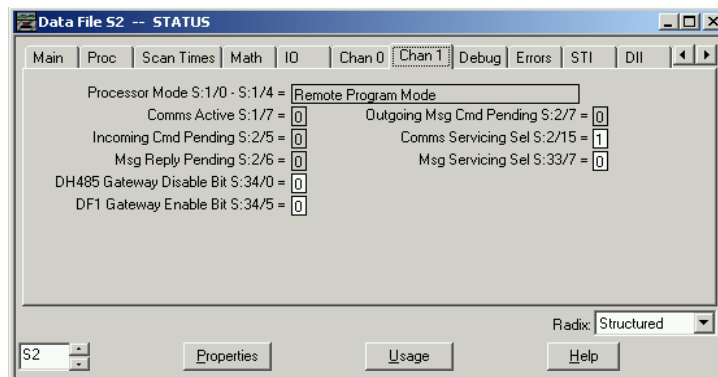
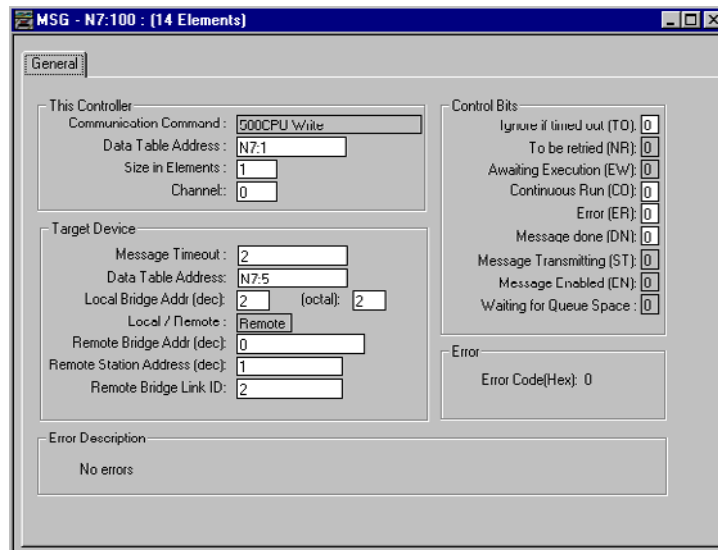
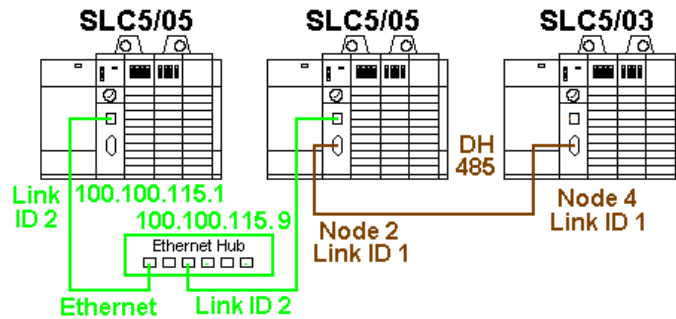

For the Step by Step procedure for this example refer to Knowledgebase Document Number: G20029.

### Passthru Example: Ethernet to DH-485

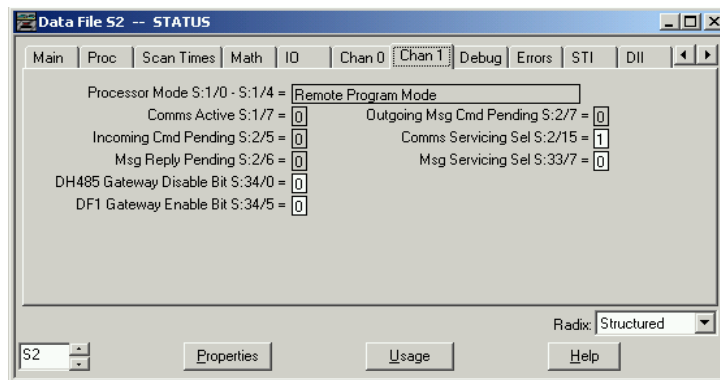
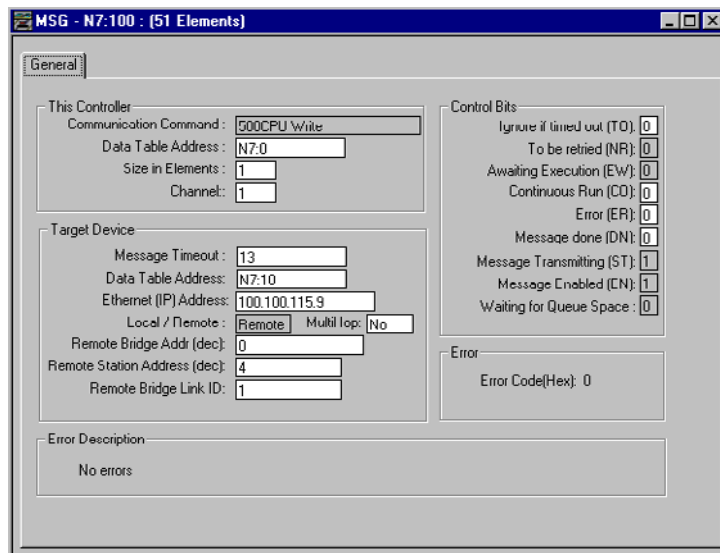
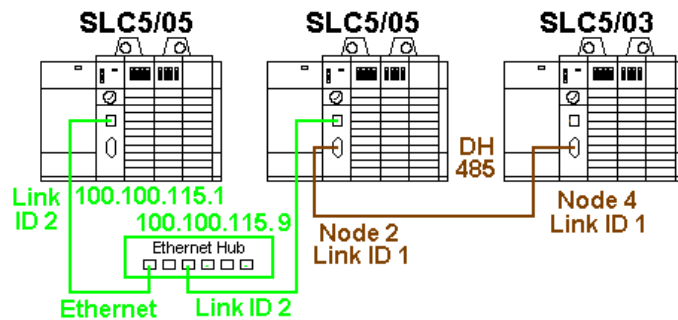

For the Step by Step procedure for this example refer to Knowledgebase Document Number: G20030.

## Remote Examples

All of the following remote examples were constructed for the following network.

### Remote Example: Network Overview

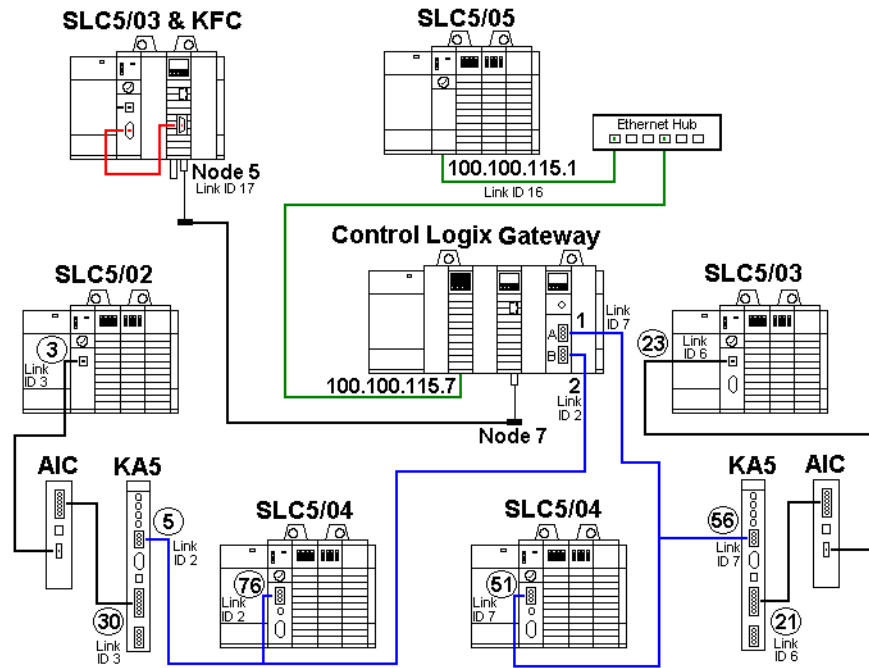

## Network Message Example: SLC 5/04 to SLC 5/02 via DHRIO and KA5

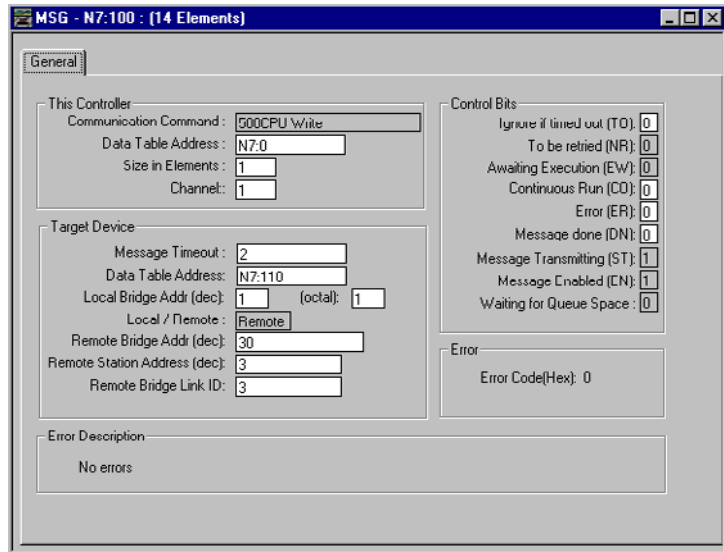
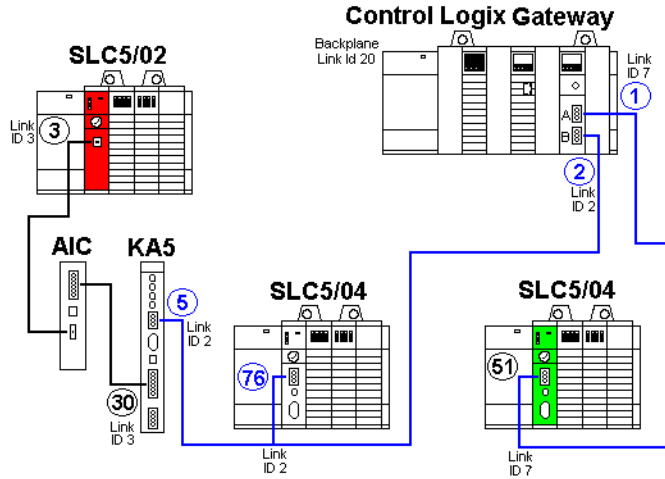

For the Step by Step procedure for this example refer to Knowledgebase Document Number: G20031.



## Network Message Example: SLC 5/04 to SLC 5/03 via DHRIO and KA5

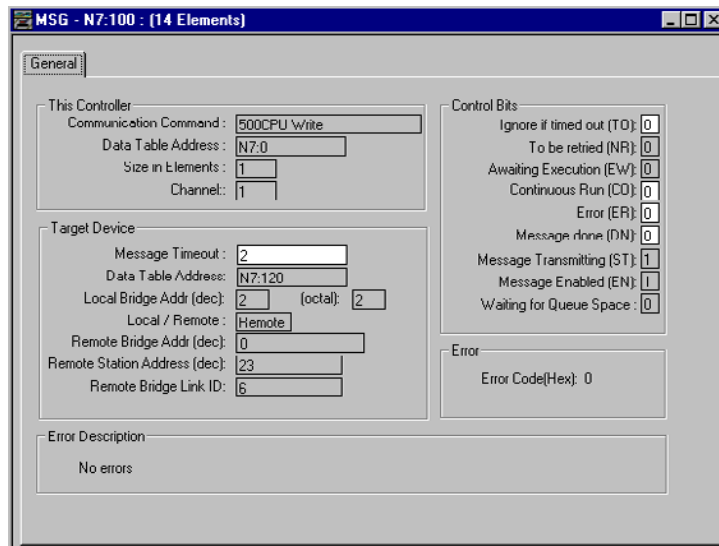
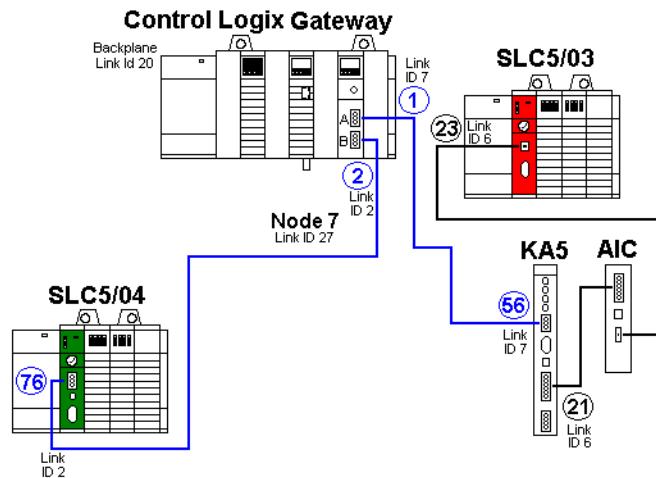

For the Step by Step procedure for this example refer to Knowledgebase Document Number: G20032.

## Network Message Example: SLC 5/04 to SLC 5/04 via DHRIO

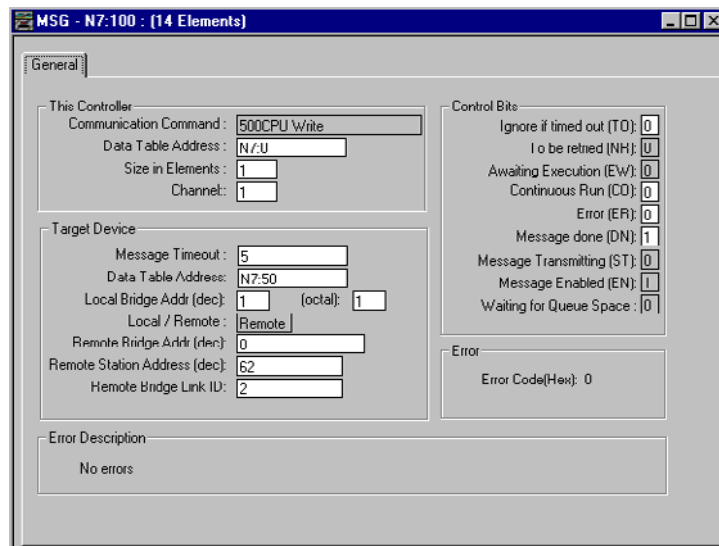
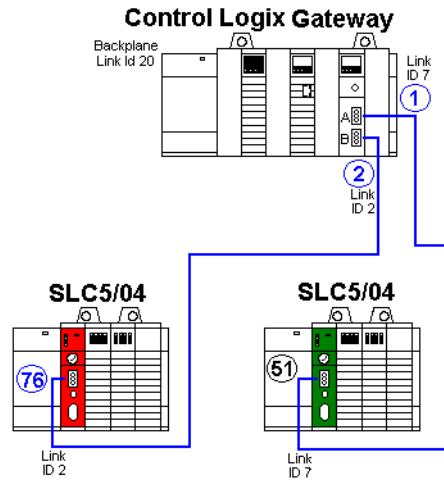

For the Step by Step procedure for this example refer to Knowledgebase Document Number: G20033.

## Network Message Example: SLC 5/04 to SLC 5/02 via KA5

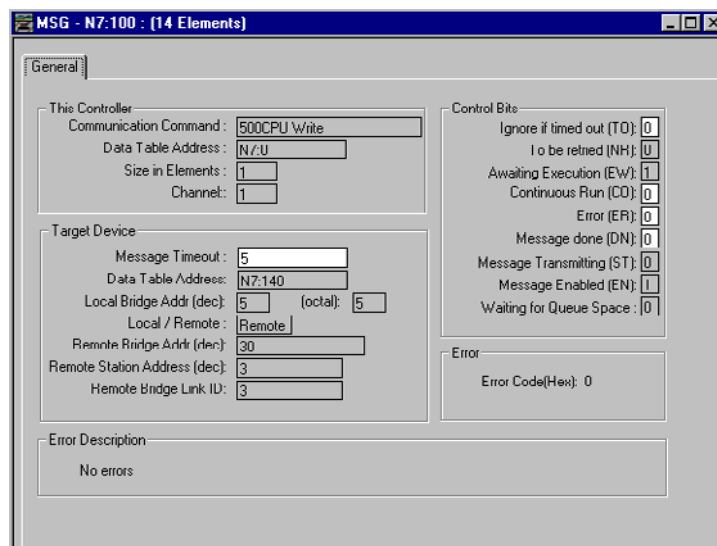
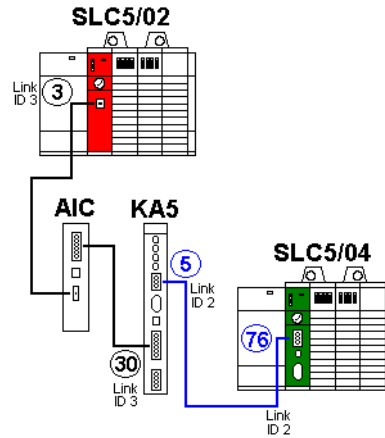

For the Step by Step procedure for this example refer to Knowledgebase Document Number: G20034.

## Network Message Example: SLC 5/04 to SLC 5/03 via KA5

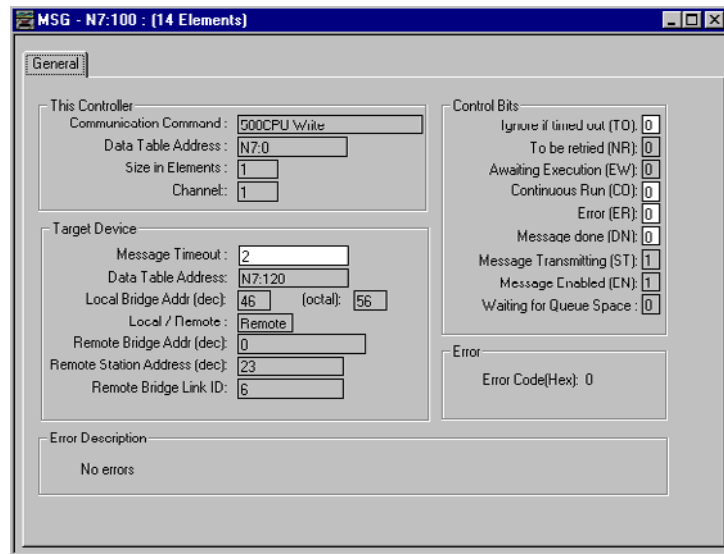
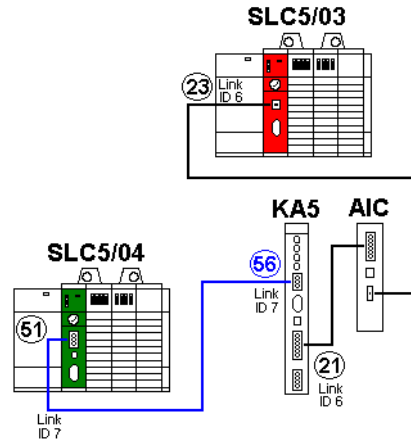

For the Step by Step procedure for this example refer to Knowledgebase Document Number: G20035.

## Network Message Example: SLC 5/04 to SLC 5/05 via DHRIO and ENET

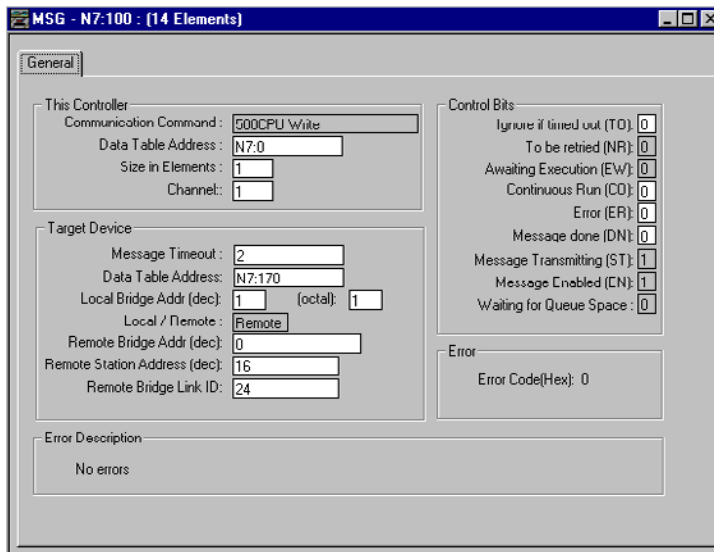
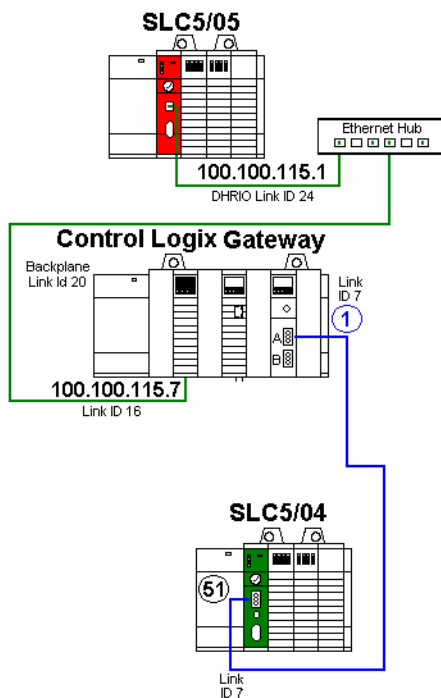

For the Step by Step procedure for this example refer to Knowledgebase Document Number: G20036.

## Network Message Example: SLC 5/05 to SLC 5/04 via ENET and DHRIO

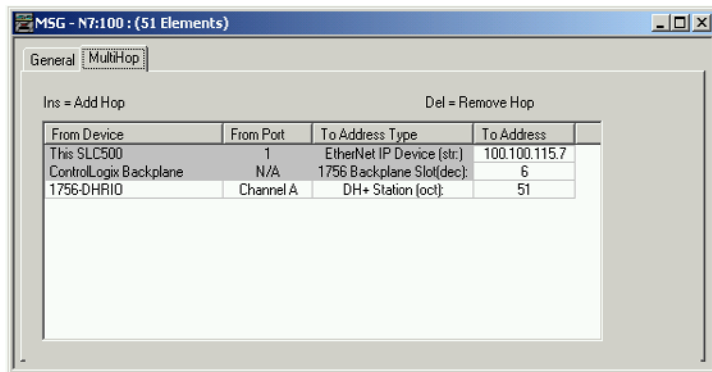
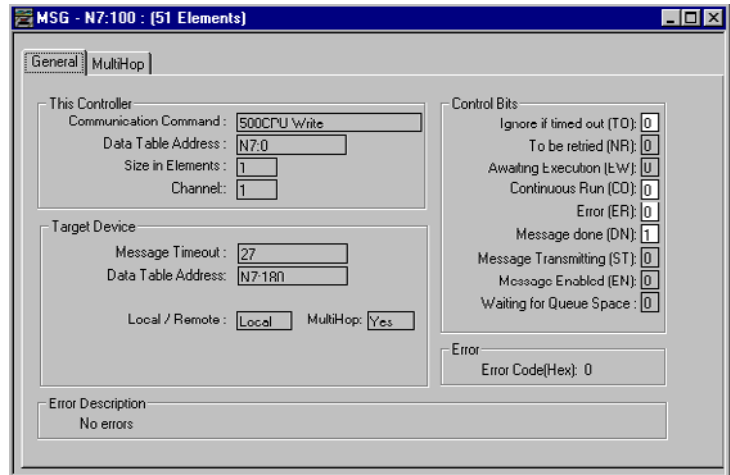
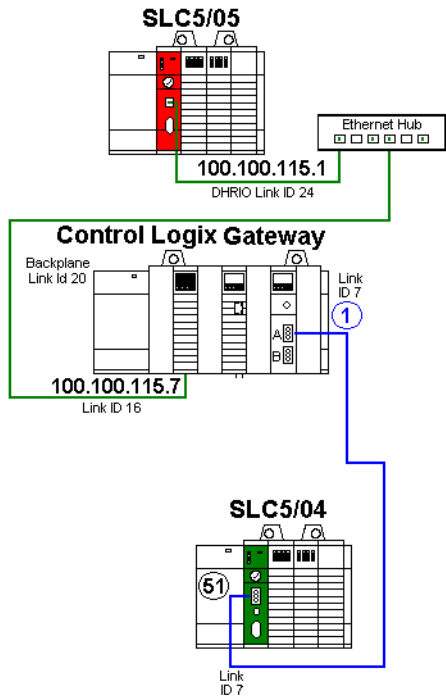

For the Step by Step procedure for this example refer to Knowledgebase Document Number: G20037.

## Network Message Example: SLC 5/05 to SLC 5/03 via ENET, CNB and KFC

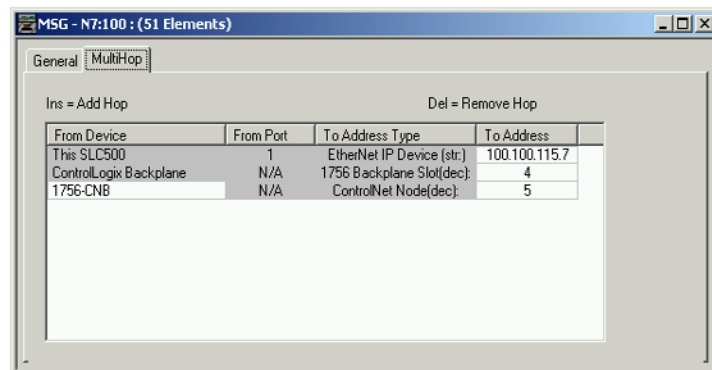
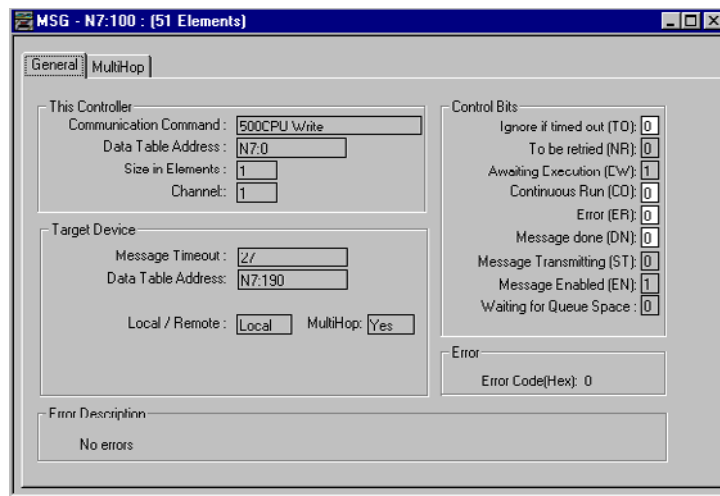
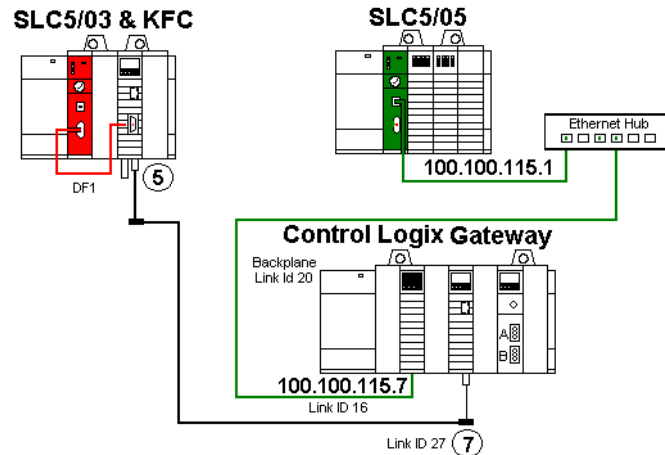

For the Step by Step procedure for this example refer to Knowledgebase Document Number: G20038.

## Network Message Example: SLC 5/05 to SLC 5/03 via ENET, DHRIO and KA5

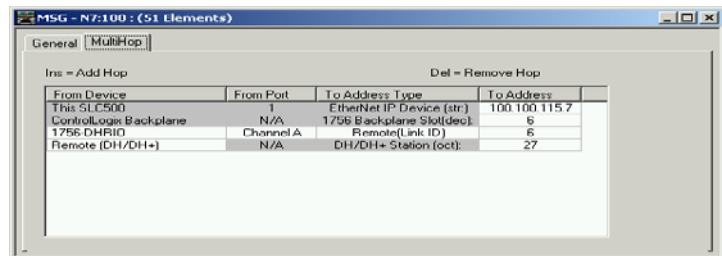
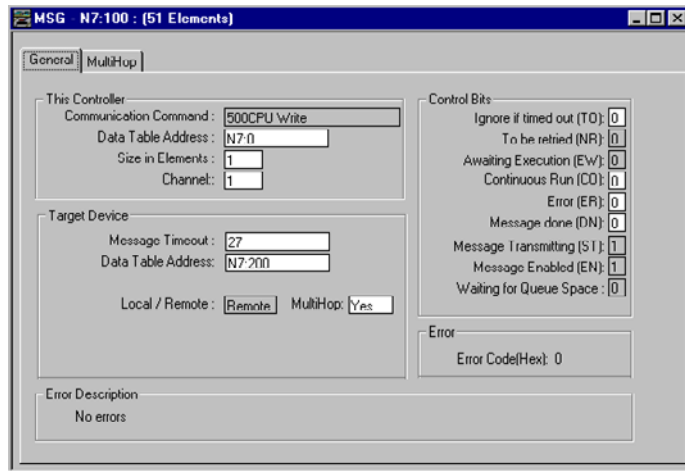
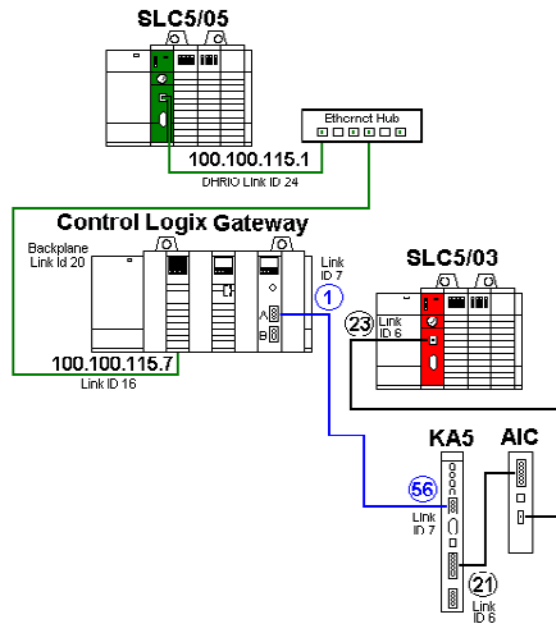

For the Step by Step procedure for this example refer to Knowledgebase Document Number: G20039.



## Network Message Example: PLC 5/20E to SLC 500 CH0 via ENI

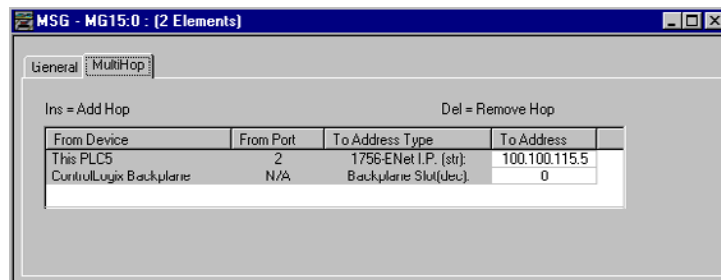
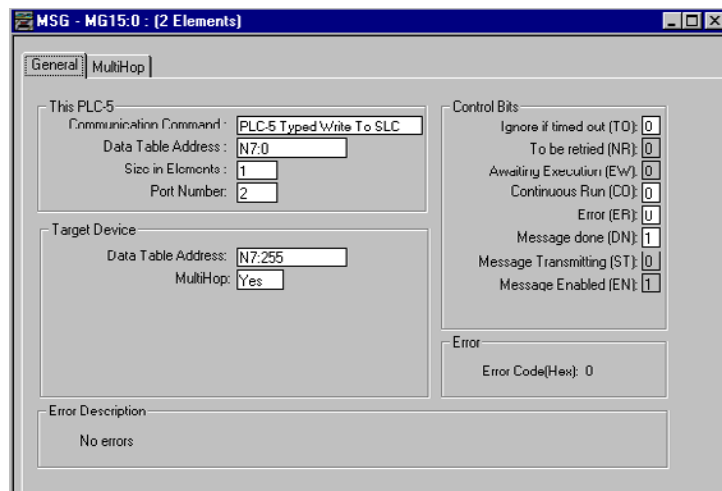
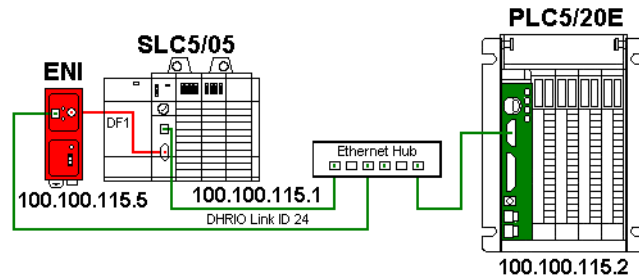

For the Step by Step procedure for this example refer to Knowledgebase Document Number: G20040.

**Notes:**

## Troubleshooting Faults

This chapter lists the major error fault codes, indicates the probable causes of faults, and recommends corrective action. This chapter also explains the operating system download faults for the SLC 5/03 (and higher) processors.

### Automatically Clear Faults

The following section describes the different ways to automatically clear a fault using your programming software.

#### SLC Processors

- Set the Fault Override at Powerup Bit S:1/8 in the status file to clear the fault when power is cycled, assuming the user program is not corrupt.
- Designate a User Fault Routine Number in S:29 and program that ladder subroutine file to attempt to correct the fault and clear S:1/13.
- Set the Startup Protection Fault Bit, S:1/9 which executes the user fault routine prior to the execution of the first scan of the ladder program when a fault condition exists.
- Set one of the autoload bits S:1/10, S:1/11, or S:1/12 in the status file of the program in an EEPROM to automatically transfer a new non-faulted program from the memory module to RAM when power is cycled.

#### TIP

You can declare your own application-specific major fault by writing your own unique value to S:6 and then setting bit S:1/13.

## Manually Clear Faults

The following section describes the different ways to manually clear a fault when using an SLC processor.

- Manually clear the major fault bit S:1/13, and the minor and major error bits S:5/0-7 in the status file, using a programming device or a Data Table Access Module. Place the processor in the REM Program mode. Correct the condition causing the fault, then return the processor to either REM Run or any of the REM Test modes.
- *SLC 5/03 and higher processors:* Toggle the keyswitch from RUN to PROGRAM and then back to RUN.

---

**ATTENTION**

SLC 5/03 and higher processors: Clearing these bits with the keyswitch in the RUN position causes the processor to immediately enter the Run mode.

---

---

**ATTENTION**

If you are online with an SLC 5/03 (or higher) processor with the keyswitch position in RUN and you press the clear major fault function key, you are warned that the processor will enter the Run mode once you clear the fault.

---

## Use the Fault Routine

When designating a subroutine file, the occurrence of recoverable or non-recoverable user faults causes the designated subroutine to be executed for one scan. If the fault is recoverable, the subroutine can be used to correct the problem and clear the fault bit S:1/13. The processor then continues in the RUN mode. If the fault is non-recoverable, the subroutine can send a message via a Message instruction to another node with error code information and/or can do an orderly shutdown of the process.

The subroutine does not execute for non-user faults.

## SLC Processor Faults

The processor faults are divided into the following types.

- Powerup errors
- Going-to-run errors
- Run errors
- User program instruction errors

### Powerup Errors

**Table 16.1 Powerup Errors**

Error Code (Hex)	Description	Probable Cause	Recommended Action
0001	NVRAM error.	<ul style="list-style-type: none"> <li>• Either noise,</li> <li>• lightning,</li> <li>• improper grounding,</li> <li>• lack of surge suppression on outputs with inductive loads, or</li> <li>• poor power source.</li> <li>• Loss of battery or capacitor backup.</li> </ul>	Correct the problem, reload the program, and run. You can use the autoload feature with a memory module to automatically reload the program and enter the Run mode.
0002	Unexpected hardware watchdog timeout.	<ul style="list-style-type: none"> <li>• Either noise,</li> <li>• lightning,</li> <li>• improper grounding,</li> <li>• lack of surge suppression on outputs with inductive loads, or</li> <li>• poor power source.</li> </ul>	Correct the problem, reload the program, and run. You can use the autoload feature with a memory module to automatically reload the program and enter the Run mode.
0003	Memory module memory error. This error can also occur when going to the REM Run mode.	Memory module is corrupted.	Re-program the memory module. If the error persists, replace the memory module.
0007	Failure during memory module transfer.	Memory module is corrupted.	Re-program the memory module. If the error persists, replace the memory module.

**Table 16.1 Powerup Errors**

<b>Error Code (Hex)</b>	<b>Description</b>	<b>Probable Cause</b>	<b>Recommended Action</b>
<b>0008</b>	Internal software error.	An unexpected software error occurred due to: <ul style="list-style-type: none"> <li>• Either noise,</li> <li>• lightning,</li> <li>• improper grounding,</li> <li>• lack of surge suppression on output with inductive loads, or</li> <li>• poor power source.</li> </ul>	Correct the problem, reload the program, and run. You can use the autoloader feature with a memory module to automatically reload the program and enter the Run mode. If the problem re-occurs, contact your RSI representative.
<b>0009</b>	Internal hardware error.	An unexpected hardware error occurred due to: <ul style="list-style-type: none"> <li>• Either noise,</li> <li>• lightning</li> <li>• improper grounding,</li> <li>• lack of surge suppression on output with inductive loads, or</li> <li>• poor power source.</li> </ul>	Correct the problem, reload the program, and run. You can use the autoloader feature with a memory module to automatically reload the program and enter the Run mode. If the problem re-occurs, contact your local Rockwell Automation representative.
—	With the keyswitch in the RUN position, the SLC processor powers up in a non-RUN state.	The keyswitch may be damaged.	Connect RS Logix 500 to the SLC processor. If the processor status shows "Remote Download in Progress" and status bits S:1/0-4 are all cleared, please contact your local Rockwell Automation representative.

## Going-to-run Errors

**Table 16.2 Going-to-Run Errors**

<b>Error Code (Hex)</b>	<b>Description</b>	<b>Probable Cause</b>	<b>Recommended Action</b>
<b>0010</b>	The processor does not meet the required revision level.	The revision level of the processor is not compatible with the revision level for which the program was developed.	Consult your local Rockwell Automation representative to purchase an upgrade kit for your processor.
<b>0011</b>	The executable program file number 2 is absent.	Incompatible or corrupt program is present.	Reload the program or reprogram with RSI programming software.

**Table 16.2 Going-to-Run Errors (Continued)**

<b>Error Code (Hex)</b>	<b>Description</b>	<b>Probable Cause</b>	<b>Recommended Action</b>
<b>0012</b>	The ladder program has a memory error.	<ul style="list-style-type: none"> <li>• Either noise,</li> <li>• lightning,</li> <li>• improper grounding,</li> <li>• lack of surge suppression on outputs with inductive loads, or</li> <li>• poor power source.</li> </ul>	Correct the problem, reload the program, and run. If the error persists, be sure to use current RSI programming software to develop and load the program.
<b>0013</b>	<ul style="list-style-type: none"> <li>• The required memory module is absent, or</li> <li>• S:1/10 or S:1/11 is not set as required by the program.</li> </ul>	<ul style="list-style-type: none"> <li>• Either one of the status bits is set in the program but the required memory module is absent, or</li> <li>• status bit S:1/10 or S:1/11 is not set in the program stored in the memory module, but it is set in the program in the processor memory.</li> </ul>	<ul style="list-style-type: none"> <li>• Either install a memory module in the processor, or</li> <li>• upload the program from the processor to the memory module.</li> </ul>
<b>0014</b>	Internal file error.	<ul style="list-style-type: none"> <li>• Either noise,</li> <li>• lightning,</li> <li>• improper grounding,</li> <li>• lack of surge suppression on outputs with inductive loads, or</li> <li>• poor power source.</li> </ul>	Correct the problem, reload the program, and run. If the error persists, be sure to use current RSI programming software to develop and load the program.
<b>0015</b>	Configuration file error.	<ul style="list-style-type: none"> <li>• Either noise,</li> <li>• lightning,</li> <li>• improper grounding,</li> <li>• lack of surge suppression on outputs with inductive loads, or</li> <li>• poor power source.</li> </ul>	Correct the problem, reload the program, and run. If the error persists, be sure to use current RSI programming software to develop and load the program.
<b>0016</b>	Startup protection after power loss. Error condition exists at powerup when bit S:1/9 is set and powerdown occurred while running.	Status bit S:1/9 has been set by the user program.	<ul style="list-style-type: none"> <li>• Either reset bit S:1/9 if this is consistent with the application requirements, and change the mode back to run, or</li> <li>• clear S:1/13, the major fault bit, before the end of the first program scan is reached.</li> </ul>
<b>0017</b>	NVRAM/memory module user program mismatch.	Bit S:2/9 is set and the memory module user program does not match the NVRAM user program.	Transfer the memory module program to NVRAM then change to Run mode.

**Table 16.2 Going-to-Run Errors (Continued)**

<b>Error Code (Hex)</b>	<b>Description</b>	<b>Probable Cause</b>	<b>Recommended Action</b>
<b>0018</b>	Incompatible user program. Operating system type mismatch. This error can also occur during powerup.	The user program is too advanced to be executed in the current operating system.	Contact your your local Rockwell Automation representative to purchase an upgrade kit for your processor.
<b>0019</b>	A duplicate label number was detected.	A duplicate or missing label instruction was found in a subroutine.	<ul style="list-style-type: none"> <li>• Either remove the duplicate label, or</li> <li>• add a label.</li> </ul>

## Run Errors

**Table 16.3 Run Errors**

<b>Error Code (Hex)</b>	<b>Description</b>	<b>Probable Cause</b>	<b>Recommended Action</b>
<b>001F</b>	A program integrity problem occurred during an online editing session.	Either noise, communication loss, or a power cycle occurred during an online edit session.	Reload the program and re-enter your changes.
<b>0004</b>	Memory error occurred while in the Run mode.	<ul style="list-style-type: none"> <li>• Either noise,</li> <li>• lightning,</li> <li>• improper grounding,</li> <li>• lack of surge suppression on outputs with inductive loads, or</li> <li>• poor power source.</li> </ul>	Correct the problem, reload the program, and run. You can use the autoloading feature with a memory module to automatically reload the program and enter the Run mode.
<b>0020</b>	A minor error bit is set at the end of the scan. Refer to S:5 minor error bits (lower byte only).	<ul style="list-style-type: none"> <li>• Either a math or FRD instruction overflow has occurred,</li> <li>• sequencer or shift register instruction error was detected,</li> <li>• a major error was detected while executing a user fault routine, or</li> <li>• M0-M1 file addresses were referenced in the user program for a disabled slot.</li> </ul>	Correct the programming problem, reload the program and enter the run mode.



**Table 16.3 Run Errors (Continued)**





Error Code (Hex)	Description	Probable Cause	Recommended Action		
<p><b>0021</b></p>	<p>A remote power failure of an expansion I/O chassis has occurred.</p> <p>Note: A modular system that encounters an over-voltage or over-current condition in any of its power supplies can produce any of the I/O error codes listed on pages page 16-12 through page 16-14 (instead of code 002). The over-voltage or over-current condition is indicated by the power supply LED being off.</p>	<p>Fixed in FRN 1 to 4 SLC 5/01 processors: Power was removed or the power dipped below specification for an expansion chassis.</p> <p>SLC 5/02 processors and above and FRN 5 SLC 5/01 processors: This error code is present only while power is not applied to an expansion chassis. This is the only self-clearing error code. When power is re-applied to the expansion chassis, the fault will be cleared.</p>	<p>Fixed and FRN 1 to 4 SLC 5/01 processors: Cycle power on the local chassis.</p> <p>SLC 5/02 processors and above and FRN 5 SLC 5/01 processors: Re-apply power to the expansion chassis.</p>		
<table border="0" style="width: 100%;"> <tr> <td style="width: 15%; vertical-align: top;"> <div style="background-color: black; color: white; padding: 2px; text-align: center; font-weight: bold;">ATTENTION</div>  </td> <td style="vertical-align: top;"> <p>Fixed and FRN 1 through 4 SLC 5/01 processors: If the remote power failure occurred while the processor was in the REM Run mode, error 0021 will cause the major error halted bit (S:1/13) to be cleared at the next powerup of the local chassis.</p> <p>SLC 5/02 and above processors and FRN 5 SLC 5/01 processors: Power to the local chassis does not need to be cycled to resume the REM Run mode. Once the remote chassis is re-powered, the CPU will restart the system.</p> </td> </tr> </table>				<div style="background-color: black; color: white; padding: 2px; text-align: center; font-weight: bold;">ATTENTION</div> 	<p>Fixed and FRN 1 through 4 SLC 5/01 processors: If the remote power failure occurred while the processor was in the REM Run mode, error 0021 will cause the major error halted bit (S:1/13) to be cleared at the next powerup of the local chassis.</p> <p>SLC 5/02 and above processors and FRN 5 SLC 5/01 processors: Power to the local chassis does not need to be cycled to resume the REM Run mode. Once the remote chassis is re-powered, the CPU will restart the system.</p>
<div style="background-color: black; color: white; padding: 2px; text-align: center; font-weight: bold;">ATTENTION</div> 	<p>Fixed and FRN 1 through 4 SLC 5/01 processors: If the remote power failure occurred while the processor was in the REM Run mode, error 0021 will cause the major error halted bit (S:1/13) to be cleared at the next powerup of the local chassis.</p> <p>SLC 5/02 and above processors and FRN 5 SLC 5/01 processors: Power to the local chassis does not need to be cycled to resume the REM Run mode. Once the remote chassis is re-powered, the CPU will restart the system.</p>				
<p><b>0022</b></p>	<p>The user watchdog scan time has been exceeded.</p>	<ul style="list-style-type: none"> <li>• Either Watchdog time is set too low for the user program, or</li> <li>• user program caught in a loop.</li> </ul>	<ul style="list-style-type: none"> <li>• Either increase the watchdog timeout in the status file (S:3H), or</li> <li>• correct the user program problem.</li> </ul>		
<p><b>0023</b></p>	<p>Invalid or non-existent STI interrupt file.</p>	<ul style="list-style-type: none"> <li>• Either an STI interrupt file number was assigned in the status file, but the subroutine file was not created, or</li> <li>• the STI interrupt file number assigned was 0, 1, or 2.</li> </ul>	<ul style="list-style-type: none"> <li>• Either disable the STI interrupt setpoint (S:30) and file number (S:31) in the status file, or</li> <li>• create an STI interrupt subroutine file for the file number assigned in the status file (S:31). The file number must not be 0, 1, or 2.</li> </ul>		
<p><b>0024</b></p>	<p>Invalid STI interrupt interval (greater than 2550 ms or negative).</p>	<p>The STI setpoint is out of range (greater than 2550 ms or negative).</p>	<ul style="list-style-type: none"> <li>• Either disable the STI interrupt setpoint (S:30) and file number (S:31) in the status file, or</li> <li>• create an STI interrupt routine for the file number referenced in the status file (S:31). The file number must not be 0, 1, or 2.</li> </ul>		

Table 16.3 Run Errors (Continued)

Error Code (Hex)	Description	Probable Cause	Recommended Action
0025	Excessive stack depth/JSR calls for the STI routine.	A JSR instruction is calling for a file number assigned to an STI routine.	Correct the user program to meet the requirements and restrictions for the JSR instruction, then reload the program and run.
0026	Excessive stack depth/JSR calls for an I/O interrupt routine.	A JSR instruction is calling for a file number assigned to an I/O interrupt routine.	Correct the user program to meet the requirements and restrictions for the JSR instruction, then reload the program and run.
0027	Excessive stack depth/JSR calls for the user fault routine.	A JSR instruction is calling for a file number assigned to the user fault routine.	Correct the user program to meet the requirements and restrictions for the JSR instruction, then reload the program and run.
0028	Invalid or non-existent "startup protection" fault routine file value.	<ul style="list-style-type: none"> <li>• Either a fault routine file number was created in the status file, but the fault routine file was not physically created, or</li> <li>• the file number created was 0, 1, or 2.</li> </ul>	<ul style="list-style-type: none"> <li>• Either disable the fault routine file number (S:29) in the status file, or</li> <li>• create a fault routine for the file number referenced in the status file (S:29). The file number must not be 0, 1, or 2.</li> </ul>
0029	Indexed address reference is outside of the entire data file space (range of B3:0 through the last file).	The program is referencing through indexed addressing an element beyond the allowed range. The range is from B3:0 to the last element of the last data file created by the user.	Correct and reload the user program. This problem cannot be corrected by writing to the index register word (S:24).
<div style="display: flex; align-items: center;"> <div style="background-color: black; color: white; padding: 2px 5px; margin-right: 10px;"><b>ATTENTION</b></div> <div> <p>The SLC processor uses an index value of zero for the faulted instruction following error recovery.</p>  </div> </div>			
002A	Indexed address reference is beyond the specific referenced data file.	The program is referencing through indexed addressing an element beyond a file boundary.	Correct the user program, allocate more data space using the memory map, or re-save the program allowing crossing of file boundaries. Reload the user program. This problem cannot be corrected by writing to the index register word (S:24).
002B	An invalid file number for an indirect address exists.	The file number exists, but it is not the correct file type or the file number does not exist.	Check the file type or create the file number.
002C	The referenced indirect address element is outside data file limits.	The indirectly referenced element does not exist, but the file type is correct and it exists.	Create the indirectly referenced element.

**Table 16.3 Run Errors (Continued)**

<b>Error Code (Hex)</b>	<b>Description</b>	<b>Probable Cause</b>	<b>Recommended Action</b>
<b>002D</b>	An invalid referenced indirect address subelement exists.	Either a subelement is referenced incorrectly or an indirect reference has been made to an M-file.	Correct the references and try again.
<b>002E</b>	Invalid DII Input slot.	The referenced slot is empty or a non-discrete I/O card is present.	Change the input slot to a discrete I/O card.
<b>002F</b>	Invalid or non-existent DII interrupt file.	<ul style="list-style-type: none"> <li>• Either an DII interrupt file number was assigned in the status file, but the subroutine file was not created, or</li> <li>• the DII interrupt file number assigned was 0, 1, or 2.</li> </ul>	Either disable the DII function by writing a zero to this location, or change the value to a valid ladder file (3-255).

## User Program Instruction Errors

**Table 16.4 User Program Instruction Errors**

<b>Error Code (Hex)</b>	<b>Description</b>	<b>Probable Cause</b>	<b>Recommended Action</b>
<b>0030</b>	An attempt was made to jump to one too many nested subroutine files. This code can also mean that a program has potential recursive routines.	<ul style="list-style-type: none"> <li>• Either more than the maximum of 4 (8 if you are using a 5/02 or 5/03 processor) levels of nested subroutines are called for in the user program, or</li> <li>• nested subroutine(s) are calling for subroutine(s) of a previous level.</li> </ul>	Correct the user program to meet the requirements and restrictions for the JSR instruction, then reload the program and run.
<b>0031</b>	An unsupported instruction reference was detected.	The type or series level of the processor does not support an instruction residing in the user program, or you have programmed a constant as the first operand of a compare instruction.	<ul style="list-style-type: none"> <li>• Either replace the processor with one that supports the user program, or</li> <li>• modify the user program so that all instructions are supported by the processor, then reload the program and run.</li> </ul>
<b>0032</b>	A sequencer instruction length/position parameter points past the end of a data file.	The program is referencing an element beyond a file boundary set up by the sequencer instruction.	Correct the user program or allocate more data file space using the memory map, then reload and run.
<b>0033</b>	The length parameter of an LFU, LFL, FFU, FFL, BSL, or BSR instruction points past the end of a data file.	The program is referencing an element beyond a file boundary set up by the instruction.	Correct the user program or allocate more data file space using the memory map, then reload and run.

**Table 16.4 User Program Instruction Errors (Continued)**

<b>Error Code (Hex)</b>	<b>Description</b>	<b>Probable Cause</b>	<b>Recommended Action</b>
<b>0034</b>	A negative value for a timer accumulator or preset value was detected. Fixed processors with 24 VDC input only: A negative or zero HSC preset was detected in a HSC instruction.	The accumulated or preset value of a timer in the user program was detected as being negative.	If the user program is moving values to the accumulated or preset word of a timer, make certain these values cannot be negative. Correct the user program, reload, and run.
<b>0034 (related to fixed 5/01 HSC instruction)</b>	A negative or zero HSC preset was detected in an HSC instruction.	The preset value for the HSC instruction is out of the valid range. Valid range is 1 to 32767.	If the user program is moving values to the preset word of the HSC instruction, make certain the values are within the valid range. Correct the user program, reload, and run.
<b>0035</b>	TND, SVC, or REF instruction is called within an interrupting or user fault routine.	A TND, SVC, or REF instruction is being used in an interrupt or user-fault routine. This is illegal.	Correct the user program, reload, and run.
<b>0036</b>	An invalid value is being used for a PID instruction parameter.	An invalid value was loaded into a PID instruction by the user program or by the user via the data monitor function for this instruction.	Code 0036 is discussed on page 9-21.
<b>0038</b>	A RET instruction was detected in a non-subroutine file.	A RET instruction resides in the main program.	Correct the user program, reload, and run.
<b>xx39</b>	An invalid string length was detected in a string file.  (xx = data file number)	The first word of string data contains a negative, zero, or value greater than 82.	Check the first word of the string data elements for invalid values and correct the user data.
<b>003A</b>	An attempt to write to a protected data file occurred.	An attempt was made to write to an indirect address located in a file that has constant data file protection.	Remove the protection and retry the function.
<b>003B</b>	Motherboard and Daughter Card firmware do not match.	Motherboard and Daughter Card were not flash upgraded as a pair.	Flash upgrade both Motherboard and Daughter Card to latest version.
<b>003C</b>	STI Watchdog timer time-out	STI setpoint set too low. The processor was not able to service the STI interrupt before its watchdog timer timeout. See page B-31.	Increase the value of the STI setpoint (S:30).
<b>005F</b>	Invalid Rack ID	Invalid rack setup or problem with rack.	For a multi-rack system, make sure no more than three racks are configured. For a single-rack system, replace the rack, the rack may be bad.

## I/O Errors

**ERROR CODES:** The characters xx in the following codes represent the slot number, in hexadecimal. If the exact slot cannot be determined, the characters xx become 03 for fixed controllers and 1F for modular controllers. Refer to the table below.

**Table 16.5 Slot Numbers**

Slot	xx (1)	Slot	xx	Slot	xx	Slot	xx
0	00	8	08	16	10	24	18
1	01	9	09	17	11	25	19
2	02	10	0A	18	12	26	1A
**3	03	11	0B	19	13	27	1B
4	04	12	0C	20	14	28	1C
5	05	13	0D	21	15	29	1D
6	06	14	0E	22	16	30	1E
7	07	15	0F	23	17	*	1F

<sup>(1)</sup> Slot numbers (xx) in hexadecimal.

**RECOVERABLE I/O FAULTS** (SLC 5/02 and higher processors only): Many I/O faults are recoverable. To recover, you must disable the specified slot, xx, in the user fault routine. If you do not disable slot xx, the processor will fault at the end of the scan.

**TIP**

An I/O card that is severely damaged may cause the processor to indicate that an error exists in slot 1.

Table 16.6 I/O Errors

Error Code (Hex)	Description	Probable Cause	Recommended Action
<b>xx50</b>	A chassis data error is detected.	<ul style="list-style-type: none"> <li>• Either noise,</li> <li>• lightning,</li> <li>• improper grounding,</li> <li>• lack of surge suppression on outputs with inductive loads, or</li> <li>• poor power source.</li> </ul>	Correct the problem, clear the fault, and re-enter Run mode.
<b>xx51</b>	A "stuck" runtime error is detected on an I/O module.	If this is a discrete I/O module, this is a noise problem. If this is a specialty I/O module, refer to the applicable user manual for the probable cause.	Cycle power to the system. If this does not correct the problem, replace the module.
<b>xx52</b>	A module required for the user program is detected as missing or removed.	An I/O module configured for a particular slot is missing or has been removed.	<ul style="list-style-type: none"> <li>• Either disable the slot in the status file (S:11 and S:12), or</li> <li>• insert the required module in the slot.</li> </ul>
<b>xx53</b>	<p>When going-to-run, a user program declares a slot as unused, and that slot is detected as having an I/O module inserted.</p> <p>This code can also mean that an I/O module has reset itself.</p>	<ul style="list-style-type: none"> <li>• Either the I/O slot is not configured for a module, but a module is present, or</li> <li>• the I/O module has reset itself.</li> </ul>	<ul style="list-style-type: none"> <li>• Either disable the slot in the status file (S:11 and S:12), clear the fault and run,</li> <li>• remove the module, clear the fault and run, or</li> <li>• modify the I/O configuration to include the module, then reload the program and run.</li> <li>• If you suspect that the module has reset itself, clear the major fault and run.</li> </ul>
	SLC 5/03 specific - An attempt was made to enter the run or test mode with an empty chassis.	A chassis is void of all I/O modules.	Disable all slots in the empty chassis (see S:11 and S:12).
<b>xx54</b>	A module required for the user program is detected as being the wrong type.	An I/O module in a particular slot is a different type than was configured for that slot by the user.	<ul style="list-style-type: none"> <li>• Either replace the module with the correct module, clear the fault, and run, or</li> <li>• change the I/O configuration for the slot, reload the program, and run.</li> </ul>
<b>xx55</b>	<p>A discrete I/O module required for the user program is detected as having the wrong I/O count.</p> <p>This code can also mean that a specialty card driver is incorrect.</p>	<ul style="list-style-type: none"> <li>• If this is a discrete I/O module, the I/O count is different from that selected in the I/O configuration.</li> <li>• If this is a specialty I/O module, the card driver is incorrect.</li> </ul>	<ul style="list-style-type: none"> <li>• If this is a discrete I/O module, replace it with a module having the I/O count selected in the I/O configuration. Then, clear the fault and run, or</li> <li>• change the I/O configuration to match the existing module, then reload the program and run.</li> <li>• If this is a specialty I/O module, refer to the user manual for that module.</li> </ul>

**Table 16.6 I/O Errors (Continued)**

<b>Error Code (Hex)</b>	<b>Description</b>	<b>Probable Cause</b>	<b>Recommended Action</b>
<b>xx56</b>	The chassis configuration specified in the user program is detected as being incorrect.	The chassis configuration specified by the user does not match the hardware.	Correct the chassis configuration, reload the program and run.
<b>xx57</b>	A specialty I/O module has not responded to a Lock Shared Memory command within the required time limit.	The specialty I/O module is not responding to the processor in the time allowed.	Cycle chassis power. If this does not correct the problem, refer to the user manual for the specialty I/O module. You may have to replace the module.
<b>xx58</b>	A specialty I/O module has generated a generic fault. The card fault bit is set (1) in the module's status byte.	Refer to the user manual of the specialty I/O module.	Cycle chassis power. If this does not correct the problem, refer to the user manual for the specialty I/O module. You may have to replace the module.
<b>xx59</b>	A specialty I/O module has not responded to a command as being completed within the required time limit.	A specialty I/O module did not complete a command from the processor in the time allowed.	Refer to the user manual for the specialty I/O module. You may have to replace the module.
<b>xx5A</b>	Hardware interrupt problem.	If this is a discrete I/O module, this is a noise problem. If this is a specialty I/O module, refer to the user manual for the module.	Cycle chassis power. Check for a noise problem and be sure proper grounding practices are used. If this is a specialty I/O module, refer to the user manual for the module. You may have to replace the module.
<b>xx5B</b>	G file configuration error - user program G file size exceeds the capacity of the module.	G file is incorrect for the module in this slot.	Refer to the user manual for the specialty I/O module. Reconfigure the G file as directed in the manual, then reload and run.
<b>xx5C</b>	M0-M1 file configuration error - user program M0-M1 file size exceeds capacity of the module.	M0-M1 files are incorrect for the module in this slot.	Refer to the user manual for the specialty I/O module. Reconfigure the M0-M1 files as directed in the manual, then reload and run.
<b>xx5D</b>	Interrupt service requested is not supported by the processor.	The specialty I/O module has requested service and the processor does not support it.	Refer to the user manual for the specialty I/O module to determine which processors support use of the module. Change processor to one that supports the module.
<b>xx5E</b>	Processor I/O driver (software) error.	Corrupt processor I/O driver software.	Reload program using RSLogix software.
<b>xx60 through xx6F</b>	Identifies an I/O module specific recoverable major error.	-	-
<b>xx70 through xx7F</b>	Identifies an I/O module specific non-recoverable major error.	-	-
<b>xx80 through xx8F</b>	Identifies a specialty I/O module specific non-recoverable major error.	-	-

Table 16.6 I/O Errors (Continued)

Error Code (Hex)	Description	Probable Cause	Recommended Action
<b>xx90</b>	Interrupt problem on a disabled slot.	A specialty I/O module requested service while a slot was disabled.	Refer to the user manual for the specialty I/O module. You may have to replace the module.
<b>xx91</b>	A disabled slot has faulted.	A specialty I/O module in a disabled slot has faulted.	Cycle chassis power. If this does not correct the problem, refer to the user manual for the specialty I/O module. You may have to replace the module.
<b>xx92</b>	Invalid or non-existent module interrupt subroutine (ISR) file.	The I/O configuration/ISR file information for a specialty I/O module is incorrect.	Correct the I/O configuration/ISR file information for the specialty I/O module. Refer to the user manual for the module for the correct ISR file information. Then reload the program and run.
<b>xx93</b>	Unsupported I/O module specific major error.	The processor does not recognize the error code from a specialty I/O module.	Refer to the user manual for the specialty I/O module.
<b>xx94</b>	A module has been detected as being inserted under power in the run or test mode. This can also mean that an I/O module has reset itself.	The module was inserted in the chassis under power, or the module has reset itself.	No module should ever be inserted in a chassis under power. If this occurs and the module is not damaged, <ul style="list-style-type: none"> <li>• Either remove the module, clear the fault and run, or</li> <li>• add the module to the I/O configuration, reference the module in the user program where required, reload the program, and run.</li> </ul>
<b>0x00A0</b> <b>0x00A1</b> <b>0x00A2</b>	A major fault unique to the SLC 5/04 or SLC 5/05. The error code indicates communication channel hardware fault has occurred.	Ethernet communication fault. or DH+ communication fault.	The fault may be cleared via a write to the System Status File, but Ethernet/DH+/RS-232 communications will be disabled until a power cycle is performed. For the SLC 5/05 only, word 15 of the System Status File provides a specific fault code for the Ethernet daughterboard when user fault code 0x00A1 is generated.



## Troubleshoot SLC 5/03 and Higher Processors

Between the time you apply power to the processor, and it has a chance to establish communication with a connected programming device, the only form of communication between you and the processor is through the LED display.

### Powerup LED Display

When power is applied, all the LEDs flash on momentarily and then off. This is part of the normal power-up sequence. Following the self test by the processor, all of the LEDs flash on again momentarily. If a user program is in a running state, the RUN LED is illuminated. If a fault exists within the processor, the FLT LED is illuminated.

### Identify Processor Errors while Downloading an Operating System

The download process takes up to 90 seconds. During this time, watch the LED display for status information. While the download is in progress, the RUN and FLT LEDs remain off. The RS232, DH-485 or DH $\pm$  Ethernet, FORCE, and BATT LEDs illuminate in a pre-defined sequence. If the download is successful, the above LEDs are illuminated.

If during the download process of an operating system type memory module or during the normal power-up self test process an error occurs, the FLT LED is illuminated and the four LEDs flash on and off at a rate of 2 seconds.

The following table describes the possible LED combinations that are displayed every other time the LEDs flash on.

**Table 16.7 LED Combinations**

<b>ON LED Display</b>	<b>Description</b>
FAULT, FORCE, DH-485, DH+ or Ethernet	Fatal hardware error exists.
FAULT, FORCE, RS232, DH-485 or DH+	A hardware watchdog timeout exists.
FAULT, BATT	NVRAM error exists.
FAULT, BATT, RS232	The contents of the operating system memory module are corrupt.
FAULT, BATT, DH-485 or DH+	The downloadable operating system is not compatible with the hardware.
FAULT, BATT, RS232, DH-485, DH+ or Ethernet	An attempt was made to download the operating system onto write-protected memory.
FAULT, BATT, FORCE	Flash EEPROM failure.
FAULT, BATT, FORCE, RS232	Failure during transmission of downloadable operating system.
FAULT, BATT, FORCE, DH-485, DH+ or Ethernet	The operating system is missing or has been corrupted.

## SLC 5/03 (OS30x), SLC 5/04 (OS40x) and SLC 5/05 (OS50x) Firmware History

**OS300, Series A, FRN 1  
released: June 1993**

**Original Release**

**OS300, Series A, FRN 2  
released: July 1993**

**Enhancements**

None

**OS300, Series A, FRN 3  
released: March 1994**

**Enhancements**

- On-Line Editing

Several changes were made to the On-Line Editing sub-system to decrease the impact to scan time.

- Instruction Performance

The IOM, JMP, JSR and OSR instructions have been modified to enhance performance.

- DII accumulator update during an STI

The STI instruction has been modified to include copying of the DII accumulator during an STI.

**OS300, Series A, FRN 4  
released: May 1994**

**Enhancements**

None

## OS301, Series A, FRN 5 released: August 1994

### Enhancements

- ASCII Instructions

The ASCII instructions ABL, ACB, ACI, ACL, ACN, AEX, AHL, AIC, ARD, ARL, ASC, ASR, AWA, and AWT are supported in this release. The STRING and ASCII data types are also supported.

- Floating Point Instructions

The instructions EQU, NEQ, LES, LEQ, GRT, GEQ, ADD, SUB, MUL, DIV, NEG, CLR, SQR, MOV, FLL, COP, LIM support floating point data in this release.

- 10usec User Interrupt Timer

The lower 16 bits of the processor's 20-bit 10usec internal free running clock is copied to either S:43 (STI), S:44(IOI), or S:45(DII) prior to executing the user interrupt ladder file. This allows a user to determine the amount of time that has elapsed between consecutive interrupt subroutines.

- PLC-5 Read/Write Capability

PLC-5 typed read and write commands can now be initiated and received.

- Average Scan Time Calculation

The average scan time calculation has been changed to more accurately calculate the average scan time.

- DTR Control

The controlling of the DTR signal has been changed so that it is turned back ON only if the forcing control bit is enabled when the processor goes from a RUN to non-RUN mode.

- Dual Message Buffering

The dual message buffering capabilities has been increased from 4 buffers for both channels to 4 buffers per channel.

- Remote Messaging

Remote messaging is now allowed beyond the maximum node address.

**OS400, Series A, FRN 1  
released: August 1994**

### **Original Release**

**OS301, Series A, FRN 6  
OS400, Series A, FRN 2  
released: November 1994**

### **Enhancements**

None

**OS301, Series A, FRN 7  
OS400, Series A, FRN 3  
released: March 1995**

### **Enhancements**

- Selection of number of data bits and stop bits with generic ASCII communications added

The Generic ASCII protocol has been expanded to allow 7 or 8 data bits and 1, 1.5, or 2 stop bits. Generic ASCII communications is selected when Channel 0 is placed into User Mode.

- Poll Time-out with DF1 Half-duplex Slave Communication

The Poll Time-out feature associated with DF1 Half-duplex Slave communications on Channel 0 has been changed so that reply data packets queued to be transmitted when a Poll Time-out occurs will no longer be purged from the queue. The only event which will now purge the reply packets is reception of a NAK from the DF1 Master. This ensures that no matter how much time elapses between when a DF1 Master sends a command packet to the 5/03 and when the master polls that same 5/03, the reply to that command will be returned by that 5/03. Command data packets generated by MSG Instructions and which are queued and waiting for transmission will still be purged with their associated MSG Instruction being errored with the type 0005 code.

- Read of Initialized Data Files during download

The 5/03 processor uses hardware to CRC data files. As a data byte is written, a CRC is generated in the next byte. When the data is read back from the processor, the CRC is automatically checked. If it fails, then a hardware error occurs and the processor resets. Therefore, by the way the CRC works, data cannot be read from the processor until it has been written. In one application, the user was continuously polling all of the processors for information by reading various data files. Since this polling could happen anytime, they were often colliding with a download procedure and causing processors to reset. A change was made in the firmware to not make use of the automatic CRC checking of data files during a download, thereby preventing this from happening.

**OS301, Series A, FRN 8  
OS400, Series A, FRN 4  
released: April 1995**

**Enhancements**

None

**OS302, Series A, FRN 9  
OS401, Series A, FRN 5  
released: December 1995**

**Enhancements**

- Indirect Addressing

Allows for simplified programming.

- Trigonometric and Exponential Math Functions

Includes SIN, COS, TAN, ASN, ACS, ATN, LN, LOG, ABS, DEG, RAD, and XPY.

- Compute (CPT) Instruction

Allows for complex math computations.

- Swap (SWP) Instruction

Allows for the exchange of the high and low bytes of a 16-bit word, providing easier manipulation of ASCII data within the SLC processors.

- Scale with Parameters (SCP) Instruction

Simplifies scaling of analog parameters.

- DF1 Half-duplex Master Protocol

Allows the processor to support SCADA master RTU applications.

- Multi-Point List

Allows for monitoring of any 32 bits from one screen.

- Global Status Flags on DH+ (OS401 only)

Provides for high-speed broadcast to all processors.

- DF1 to DH+ Passthru (OS401 only)

Allows user to connect to the SLC 5/04 processor's serial port with a computer and then access any node on the DH+ network, regardless of the baud rate of the DH+ network.

- Remote I/O (RIO) Passthru via a 1747-SN Scanner Module (OS401 only)

Allows an SLC 5/04 processor to act as a bridge between DH+ and RIO. Remote I/O passthru also supports uploads/downloads of applications to RIO devices.

- Program Memory of 12K, 28K, or 60K words and 4K of additional data words (OS401 only)

Offers a variety of modular processors that fit a variety of memory requirements.

Catalog # Memory

Previous: 1747-L542 20k words + 4k

New: 1747-L541

1747-L542

1747-L543

12k words + 4k

28k words + 4k

60k words + 4k

## **OS401, Series A, FRN 6 released: May 1996**

### **Enhancements**

None

## **OS302, Series B, FRN 10 OS401, Series B, FRN 7 released: July 1997**

### **Enhancements**

- Day of the Week

System Status File word S:53 = 0 for Sunday, 1 for Monday, up to 6 for Saturday. It will contain a random value until a legal date is entered into the System Status File. A download of a user program with a valid date or manual entry of a valid date will work. Once a value is entered, it will be non-volatile.

### **Special Note**

This is the first firmware release for the 8k SLC 5/03.

**OS500, Series A, FRN 1  
released: October 1997**

### **Original Release**

**OS302, Series B, FRN 11  
OS401, Series B, FRN 8  
OS500, Series A, FRN 2  
released: November 1997**

### **Enhancements**

19200 DF1 FD Default Baud Rate (OS302 and OS401 only)

The default baud rate of channel 0 has been modified from 1200 to 19200.

**OS302, Series B, FRN 12  
released: November 1998  
OS401, Series B, FRN 9  
released: July, 1999  
OS501, Series A, FRN 3  
released: July 1998**

### **Enhancements (OS501 only)**

- Channel 0 (DF1 FD & DH-485) to Channel 1 (Ethernet) Passthru
- Channel 1 (Ethernet) Remote Messaging

**OS302, Series B, FRN 12  
released: November 1998  
OS401, Series B, FRN 9  
released: July 1999  
OS501, Series A, FRN 4  
released: February 1999**

### **Enhancements**

None

**OS302, Series B, FRN 14  
OS401, Series B, FRN 9  
released: July 1999  
OS501, Series A, FRN 4  
released: February, 1999**

### **Enhancements**

- Daughtercard Fault Signal (OS302 and OS401 only)

When the daughtercard sends a fault signal to the motherboard, the motherboard will stop the communication of the processor and set error code 0xA1. Communications will be restored after power is cycled to the processor.

- Improve Interrupt Performance



In the previous release, it took 60  $\mu$ sec when saving interrupt information at the end of scan. This has been improved to 40  $\mu$ sec.

- Improve Accuracy of Last Scan Time
- Autoload Memory Module Program

In the previous release, when the bit S2:1/10 (Load Memory Module on Memory Error bit) is set, if the processor has a hardware error of 0x01 at power up, the program in a memory module can be automatically transferred from memory to the processor. In the current release, when the bit S2:1/10 (Load Memory Module on Memory Error bit) is set, if the processor has a hardware error of 0x01 to 0x0F at power up, the program in a memory module can be automatically transferred from memory to the processor.

## **OS501, Series A, FRN 5 released: April 1999**

### **Enhancements**

Multi-hop Messaging

Support was added for sending messages to and receiving messages from ControlLogix Ethernet cards.

## **OS302, Series C, FRN 3 OS401, Series C, FRN 3 OS501, Series C, FRN 3 released: September 2000**

### **Enhancements**

- Added Block Transfer Instructions (BTR and BTW)

With block-transfer instructions, you can transfer up to 64 words to or from a remote device over an Allen-Bradley RIO link. A Block Transfer Read (BTR) is used when a remote device transfers data to the SLC. A Block Transfer Write (BTW) is used when an SLC processor writes data to a remote device. The RIO scanners (1747-SN and 1747-BSN) perform block transfer through M0 and M1 files buffers.

A BTR or BTW instruction writes information into its control structure address (a three-word control file) when the instruction is entered. The processor uses these values to execute the transfer.

- Read High Speed Clock Instruction (RHC)

The SLC processor maintains a 10 $\mu$ S long integer free running clock/counter. This 20-bit value increments every 10 $\mu$ S. It is accessed using the RHC instruction. When the RHC is evaluated with a false rung state, during prescan, or inside of a false MCR zone, no operation is performed. When the RHC is evaluated with a true rungstate, the

instruction moves the current value of the 10uS free running clock into the destination address. If it is an integer address, it only moves the least 16 bits into the address. If it is a float address, it converts the long integer value into a float and moves it to the relative address. After the free running clock reaches 0xffff value (10.4857 sec), it will wrap around to 0 and continues incrementing. The RESET signal or Power Cycle will set this free running clock to 0.

- Compute Time Difference Instruction (TDF)

The compute Time Difference Instruction (TDF) is used to calculate the elapsed time between any 2 timestamps captured using the RHC instruction. This allows the user program to time any event using a 10uS timebase.

When the TDF is evaluated with a false rungstate, during pre-scan, or inside a false MCR zone, no operation is performed. When the TDF is evaluated with a true rungstate, the instruction calculates the number of 10uS “ticks” that have elapsed from the Start value to the Stop value and places the result into the Destination. The TDF instruction with float address will accurately compute the time difference between any 2 timestamps captured within 10.48575 seconds of each other (1048575 10uS ticks). The TDF with float address will calculate an invalid result if more than 10.48575 seconds have elapsed between the start and stop timestamps. Meanwhile, the TDF instruction with integer address will compute the positive time difference between the START and END timestamps. The TDF with integer address will calculate an invalid result if more than 327.67ms have elapsed between the start and stop timestamps.

- Encode 1 of 16 to 4 Instruction (ENC)

The ENC instruction provides the ability to give the first set bit position in an integer value.

When the rung is true, this output instruction searches the source from the lowest to the highest bit, and looks for the first set bit. The corresponding bit position is written to the destination integer.

- Ramp Instruction (RMP)

The Ramp (RMP) instruction provides the ability to create linear, acceleration, deceleration, and “S” curve ramp output data wave forms. The instruction provides a means to ramp analog outputs when using them to control devices such as valves.

When the Ramp function is triggered, parameters are validated to be in range. If the parameters are valid, the ramp function places the Beginning Output Value in the Destination register. The format of the control block will be defined as part of the development process. It is

permissible for the control block to take up User Ladder Program space as well as use additional user memory for storing runtime ramp information that is not user accessible.

- File Bit Comparison Instruction (FBC) and Diagnostic Detect Instruction (DDT)

The FBC and DDT diagnostic instructions are output instructions that you can use to monitor machine or process operations to detect malfunctions. If you want to detect malfunction by comparing bits in a file of real-time inputs with a reference bit file that represents correct operation, use FBC instruction. If you want to change the reference file to match the input file, use DDT.

Both the FBC and DDT instructions compare bits in a file of real-time machine or process values (input file) with bits in a reference file, detect deviations, and record mismatched bit numbers. They record the position of each mismatch found and place this information in the result file. If no mismatches are found, the DN bit is set but the result file remains unchanged.

The difference between the FBC and DDT instructions is that each time the DDT instruction finds a mismatch, the processor changes the reference bit to match the source bit. The FBC instruction does not change the reference bit. Use the DDT instruction to update your reference file to reflect changing machine or process conditions.

- Messaging Interrupt Message Reply

Change 'Message Reply' disable/enable interrupt scheme to enhance system performance during STI execution.

- RIO Passthru Function for BSN

The passthru function is now enabled for both the 1747-SN and the 1747-BSN.

- Error Code Trapping 'Operating System'

The error code trapping is used to get the latest 8 error structures for hard faults. Error structures are retentive after power cycle, assuming the battery is connected and charged. Error code trapping only works for hard faults (0x00—0x0F).

- Updated Operating System Flash programming Algorithm to include 5V 'JEDEC'

This change is required to allow memory module hardware upgrades to 5V flash technology.

- Message Error Code (OS501 only)

After a Unix Server has defined the unsolicited “Client” IP address in SLC 5/05, the Server is removed from the network. The SLC 5/05 “Client” messages continue to be initiated since the user program re-triggers them on a message error. The “Client” messages normally error out with a 0x10 error code (invalid command parameters), probably since the Server’s IP address has been removed from the “Client” IP table. However, the messages stop re-triggering after several seconds indicating that the message was “done” with an error code 0x10.

The mother board firmware will add one feature to give more error information for the MSG instruction. Two more bits (word 12 bit 0 and word 12 bit 1) in control block are used to give the error information. When daughtercard returns error code, .ER is set, bit 1 (word 12 bit 0) in control block is set, error code, which is a non-zero value, will be put into the control block. When daughtercard returns no error code, and motherboard got an error code in the PCCC command reply, .ER is set, bit 2 (word 12 bit 1) is set, error code, which is a non-zero value, will be put into the control block. When daughtercard has no error return, and motherboard get the right PCCC reply without error, DN is set, bit 1 and bit 2 are reset error code in control block will be 0. Bits.ER, bit 1 and bit 2 will be reset once the MSG is enabled.

- Daughtercard Firmware Revision/Series Check (OS501 only)

A new feature will be added in the current release to check the daughter card firmware revision/series. This feature will be implemented in the power up. When the daughter card series is not same to a specific number, or daughter card revision is not same to a specific number, a non-user fault (0x3B) will occur. If series is 9999, no fault occurs.

- Expanded Channel 1 Diagnostic File (OS501 only)

The processor can support channel 1 diagnostic file. This diagnostic file can be any user defined integer file, which file number is in the range of 9 to 255. The existing diagnostic information structure size in firmware is 44 words. However, the new daughtercard supports 50 words information. The 45th word contains the number of network storms since the last power cycle. The 46th word to 48th word contains the Ethernet hardware address. The 49th word and 50th word contains IP address. In the new firmware release, the diagnostic information structure in firmware will be expanded to 50 words to get all the channel 1 information from daughtercard to match daughtercard requirement.

- Update NETBSD TCP/IP Stack (OS501 only)

The Berkley NETBSD TCP/IP stack was recently ported over to the 1756-ENET module to replace the Berkley Software Distribution

(BSD) that has been in use since the development of the PLC-5 Ethernet over eight years ago. This stack was also ported over to the legacy Ethernet products to let us take advantage of any bug fixes we did not pickup over the years, enhanced UDP message support and the ability to do super-netting.

- Addition of Connection Count Added to Diagnostics (OS501 only)

The diagnostic sub-segment in the dualport was modified to contain a count of the total ethernet connections, the inbound connections and the outbound connections. This data is transferred to the ethernet channel diagnostic file (if of sufficient length) during the motherboard housekeeping. The counts are available at word 50 (total), 51 (inbound) and 52 (outbound) in the diagnostic file for the ethernet channel.

- Addition of IBD (I Be Dead) Data Added to Diagnostics (OS501 only)

The diagnostic sub-segment in the dualport was modified to contain IBD data upon crash of the daughtercard. If the crash occurs after communication with the motherboard is established, this data is transferred to the ethernet channel diagnostic file (if of sufficient length) during the motherboard housekeeping. The data contains register, stack, address, traceback and error information about the crash. The data starts at word offset 5 of the diagnostic file. This will allow the IBD data to be maintained in the diagnostic file over subsequent power-cycles, allowing for support analysis.

- Memory Module Bootp problem (OS501 only)

Currently, there is a bug for the memory module. If S2:1/10 bit (Load Memory Module on Memory Error Bit) is set, when processor has hardware fault, program in memory module will be loaded into the processor, the IP address in memory module will be applied with bootp is disabled in the memory module. However, current processor applies the IP address set by bootp under above situation.

**OS302, Series C, FRN 4  
OS401, Series C, FRN 4  
OS501, Series C, FRN 4  
released: February 2001**

## **Enhancements**

None

**OS302, Series C, FRN 5  
OS401, Series C, FRN 5  
OS501, Series C, FRN 5  
released: October 2001****Enhancements**

- Additional Ethernet connections for 32k and 64k processors (OS501 only)

The total number of available Ethernet connections has increased by eight from 16 to 24 in the 32k (L552) and 64k (L553) SLC 5/05 processors. Four connections are reserved for incoming (client) messages, four connections are reserved for outgoing (peer) messages and 16 connections can be used for either incoming or outgoing messages. Therefore, the maximum number of connections in either direction is 20.

For the 16k (L551) SLC 5/05 processor, the total number of available Ethernet connections remains at 16, and the maximum number of connections in either direction remains at 12.

- Embedded web server capability for module information, TCP/IP configuration and diagnostic information (OS501 only)

The SLC 5/05 processor now includes an embedded web server which allows viewing of module information, TCP/IP configuration and diagnostic information via Ethernet using a standard web browser. In order to view the web server main menu, type in “http://www.xxx.yyy.zzz” for the web address in the web browser, where www.xxx.yyy.zzz is the IP address of the SLC 5/05 processor.

- Domain Name System (DNS) support in the Ethernet message instruction (OS501 only)

The SLC 5/05 Ethernet MSG instruction now includes DNS support, which allows entering in a device name of up to 41 characters in place of an IP addresses. Before making a connection to that device, the SLC 5/05 will query a Domain Name Server on the Ethernet network for the IP address of the device with that name. In order to successfully use the DNS capability, a “Primary Name Server” must be defined in the Channel 1 Ethernet Configuration. A “Secondary Name Server” and “Default Domain Name” may also be configured. If a “Default Domain Name” is configured, then it gets appended to every device name that is entered into an Ethernet MSG instruction.

**TIP**

RSLogix 500 version 5.20 or higher must be used to take advantage of this DNS capability.

**OS302, Series C, FRN 6**  
**OS401, Series C, FRN 6**  
**OS501, Series C, FRN 6**  
**released: November 2002**

## Enhancements

- Response support for additional PLC-5 style commands

SLC 5/03, 5/04 and 5/05 processors now can receive and respond to the following additional PLC-5 style commands received through channel 0 or channel 1.

The Bit Write and Read-Modify-Write commands are used to write one or more bits within a particular word of data in any data table integer or binary file, as well as bits within status file words.

The Word Range Read command allows a block of words (up to the maximum supported by the receiving channel) to be read from any data table file.

The Word Range Write command allows a block of words to be written (up to the maximum supported by the receiving channel) to any data table file (subject to configured file write protection, if any), except for the I/O image files.

For all four commands, the PLC-5 system address may be encoded as either a logical binary address or a logical ASCII address.

- Channel diagnostic counter reset command

When a diagnostic counter reset command is sent to the processor (RSWho, RSLogix 500 or another application), the diagnostic counters for both channel 0 and channel 1 are reset. Previously, only the counters on the channel where the command was received was reset.

- DF1/DH-485 broadcast support

Broadcast write commands received through channel 0 can be executed with the previously unsupported channel 0 system mode drivers (DF1 Full-duplex and DF1 Radio Modem).

Broadcast write commands can be initiated via the MSG instruction for all channel 0 system mode drivers and for channel 1 (DH-485) on the SLC 5/03 processor.

Previously, SLC 5/03, 5/04 and 5/05 processors supported the reception of broadcast write commands via DF1 Half-duplex and DH-485 networks. Broadcast write commands are commands sent to node 255. When a broadcast write command is received without error, the receiver attempts to execute the command, but never returns a reply to the write command. This allows a single command to synchronize all of the devices receiving that command on the local network. This can be used to simultaneously set all of the device clocks on the network or to

coordinate a timed sequence of events among multiple processors on the network.

- DF1 radio modem channel 0 driver

This driver implements a protocol, optimized for use with radio modem networks, that is a hybrid between DF1 Full-duplex protocol and DF1 Half-duplex protocol, and therefore is not compatible with either of these protocols.

Like DF1 Full-duplex protocol, DF1 Radio Modem allows any node to initiate to any other node at any time (if the radio modem network supports full-duplex data port buffering and radio transmission collision avoidance). Like DF1 Half-duplex protocol, a node ignores any packets received that have a destination address other than its own, with the exception of broadcast packets and passthru packets.

Unlike either DF1 Full-duplex or DF1 Half-duplex protocols, DF1 Radio Modem protocol does not include ACKs, NAKs, ENQs, or poll packets. Data integrity is ensured by the CRC checksum.

- DF1 channel-to-channel passthru

Channel 0 DF1-to-Channel 1 passthru on the SLC 5/04 and 5/05 processors can work with the DF1 Half-duplex Master and DF1 Radio Modem drivers, in addition to the DF1 Full-duplex driver. The S:34/5 Status File bit is used to enable DF1 passthru functionality for the channel 0 DF1 Half-duplex Master and DF1 Radio Modem drivers, as well as for the DF1 Full-duplex driver. For the SLC 5/05 processor, a Passthru Routing Table must also exist and be configured before channel-to-channel passthru can occur.

- SLC 5/05 embedded web server capability

SLC 5/05 processors with OS501, Series C, FRN 6 (or higher) includes the data table memory map, data table monitor screen, and user-provided web pages via Ethernet using a standard web browser.

In order to view the web server main menu from a standard web browser, type in `http://www.xxx.yyy.zzz` for the web address, where `www.xxx.yyy.zzz` is the IP address of the SLC 5/05 processor.



**OS302, Series C, FRN 7**  
**OS401, Series C, FRN 7**  
**OS501, Series C, FRN 7**  
**released: November 2003**

## Enhancements

- SLC 5/03 channel-to-channel passthru including the following operations:
  - Channel 0 DF1 Local to Channel 1 DH-485 Remote
  - Channel 0 DF1 Local to Channel 1 DH-485 Local
  - Channel 0 DH-485 Remote to Channel 1 DH-485 Remote
  - Channel 1 DH-485 Remote to Channel 0 DH-485 Remote
- DF1 radio modem driver

Additions of Store and Forward and several handshaking protocols to the DF1 Radio Modem driver enhance the flexibility of this driver. Store and Forward operation allows nodes to re-broadcast packets received that are not targeting the listening node. This is an important addition for messaging to out-of-range nodes using in-range nodes as repeaters.

Two handshaking protocols were added to support handshaking methods used by many radio modems. The two new handshaking protocols include:

- Half-duplex with Continuous Carrier
- Half-duplex without Continuous Carrier

Half-duplex with Continuous Carrier implies that the state of the carrier input signal DCD is ignored for transmissions.

Half-duplex without Continuous Carrier implies that the state of the carrier input signal DCD determines if the SLC processor can transmit or receive. If the DCD is high, then receptions are possible. If DCD is low, then transmissions are possible.

- Clearing DF1 communication buffers with ASCII Clear Buffer (ACL) instruction

This enhancement provides the ability to clear DF1 communication buffers using the ACL instruction. This enhancement is useful in Master/Slave applications when communication errors result in the slave buffers filling up so that it can no longer respond to the Master, and the Master is not polling the Slave because it is no longer getting any responses. In this situation the Channel 0 Incoming Command Pending bit, S:33/0 will be set.

**OS302, Series C, FRN 8  
OS401, Series C, FRN 8  
OS501, Series C, FRN 8  
released: May 2004**

**Enhancements**

None

**OS501, Series C, FRN 9  
released: November 2004**

**Enhancements**

**IMPORTANT**

Only SLC 5/05 Series C processor hardware can support 100 Mbps Ethernet and increased Ethernet connections. Updating processor hardware Series A and B to OS501, Series C, FRN 9 does not increase either the Ethernet port speed or the number of available Ethernet connections on the processors.

- Enable/Disable HTTP (Web) Server

Using RSLogix 500 V6.30 and higher, you can disable the SLC 5/05 HTTP web server functionality from within the Channel 1 Configuration by unchecking the HTTP Server Enable check box shown in Figure A.1.

**Figure A.1 Channel 1 System Configuration Defaults**

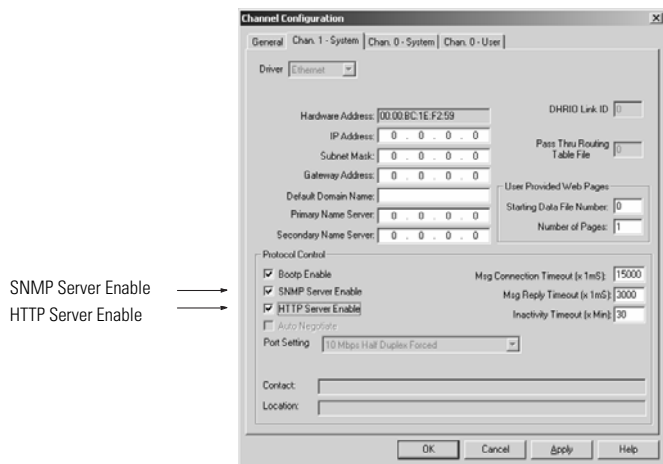

The default (checked HTTP Server Enable box shown in Figure A.1) allows you to connect to the SLC 5/05 using a web browser. Although this parameter can be downloaded to the processor as part of a program download or changed and applied while online with the processor, a processor power cycle is required in order for the change to take affect.

- Enable/Disable Simple Network Management Protocol (SNMP)

Using RSLogix 500 V6.30 and higher, you can disable the SLC 5/05 SNMP functionality from within the Channel 1 Configuration by unchecking the SNMP Server Enable check box shown in Figure A.1.

The default (checked SNMP Server Enable box shown in Figure A.1) allows you to connect to the SLC 5/05 using an SNMP client. Although this parameter can be downloaded to the processor as part of a program download or changed and applied while online with the processor, a processor power cycle is required in order for the change to take affect.

### IMPORTANT

Since SNMP is used as part of the ControlFlash firmware upgrade process, the SNMP server must be enabled prior to beginning the firmware upgrade.

- Selectively Disabling Individual Data Files from Web View

Using RSLogix 500 V6.30 and higher, you can disable individual data files from being viewed via any web browser by selecting the data file's properties page and checking the Web View Disable check box as shown in Figure A.2. Any data file property changes must be made offline and downloaded to the processor.

**Figure A.2 Web View Disable Check Box**

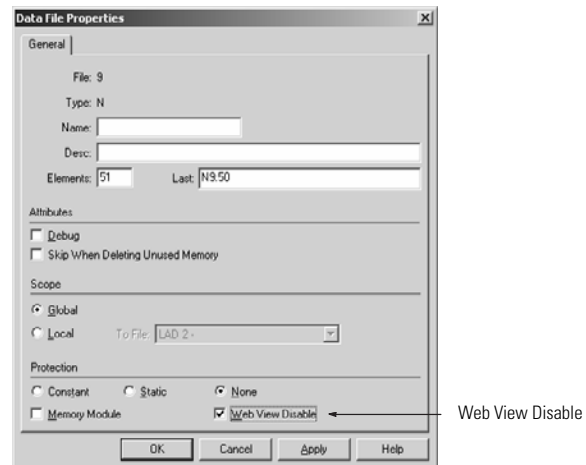

- More Secure Processor Ownership Behavior

Several RSLogix 500 online operations require obtaining the processor Edit Resource/Processor Ownership in order to ensure that one programming terminal has exclusive capability of performing any of these operations at a time. These operations include downloading, online editing, and applying channel configuration changes. An enhancement was made in FRN 9 to ensure this ownership exclusivity via EtherNet/IP, even when multiple programming terminals are routing through a single ControlLogix gateway. With FRN 9, if routing through a ControlLogix gateway or connecting to the same Ethernet

network as the SLC 5/05 using the RSLinx Ethernet/IP driver (AB\_ETHIP-x), the RSLinx CIP Options need to be configured for Messaging as shown in Figure A.3.

**Figure A.3 RSLinx CIP Options Configuration**

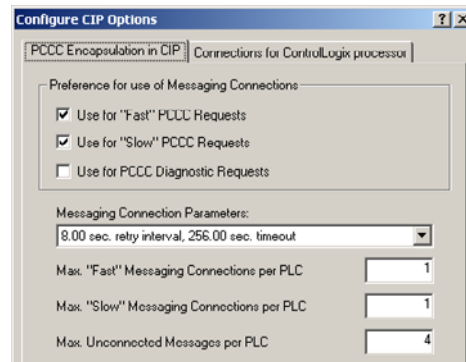

In addition to reducing the number of RSLinx Messaging Connections per PLC to one, it is also recommended that the Messaging Connection Retry Interval be increased from the default of 1.25 seconds to 8 seconds as shown in Figure A.3.

**OS302, Series C, FRN 10  
OS401, Series C, FRN 10  
OS501, Series C, FRN 10  
released: January 2006****Enhancements**

- Three new explicit message instructions:
  - CEM (ControlNet Explicit Message)
  - DEM (DeviceNet Explicit Message)
  - EEM (EtherNet/IP Explicit Message) – SLC 5/05 only

The CEM, DEM and EEM explicit message instructions allow generic Common Industrial Protocol (CIP) commands to be initiated to devices, such as drives, communicating on ControlNet, DeviceNet and EtherNet/IP networks, respectively. All three instructions require RSLogix 500 version 7.10 or higher software for programming.

The CEM instruction utilizes the explicit message capability built into the 1747-SCNR ControlNet scanner module, while the DEM instruction utilizes the explicit message capability built into the 1747-SDN DeviceNet scanner module. While not adding any additional capability over what already exists in the scanner modules, the CEM and DEM instructions greatly simplify the programming, configuration, monitoring and troubleshooting of explicit messages on ControlNet and DeviceNet.

The EEM instruction provides new explicit message capability for the SLC 5/05 processor on an EtherNet/IP network. This capability is implemented through the processor's channel one Ethernet port. It shares the same queuing and buffering scheme, as well as Ethernet connection resources, that are used by the Ethernet MSG instruction.

- New Read Program Checksum (RPC) instruction

The RPC instruction copies the checksum of the processor program from either the processor's RAM memory or from the installed memory module into the designated destination integer file location. The program checksum is a 16-bit value that is calculated for the entire ladder logic image, excluding data table values. The checksum changes any time program edits are made. Therefore, the RPC instruction can be used within the user ladder logic to determine whether online edits have changed the checksum from a known value or can verify that the program in the memory module matches the program in the processor's RAM memory.

This instruction requires RSLogix 500 version 7.10 or higher software for programming.

- Dynamic Host Configuration Protocol (DHCP) capability – SLC 5/05 only

DHCP is another option for dynamically configuring the IP address of the SLC 5/05 processor channel 1 Ethernet port (in addition to BOOTP). When the SLC 5/05 is configured for DHCP, it will broadcast a DHCP request at every power-up requesting that an IP address be assigned to it. Any DHCP server that receives the request can respond to it. The main difference between DHCP and BOOTP is that while a BOOTP server will normally assign the same IP address every time to a particular Ethernet device, based on its MAC address, a DHCP server may assign any IP address from a pool of valid addresses.

This capability requires RSLogix 500 version 7.10 or higher software for configuring.

- Secured processor capability using RSAssetSecurity

Using the RSAssetSecurity software service of the FactoryTalk Automation Platform, RSLogix 500 version 7.10 or higher programming software can configure a processor to be “permanently” secured against future unauthorized programming software access.

Once secured, only users who have been authenticated and authorized via RSAssetSecurity will be able to go online and upload/download this processor using RSLogix 500 version 7.10 or higher. The only way to unsecure a secured processor is to either disconnect the battery and clear processor memory back to factory default, or to install a memory module with an unsecured program configured to auto-load at power-up.

The Secure Processor checkbox is found on the Controller Properties General tab. A new read-only status file bit, S:34/8, reflects the secured status of the processor (0=unsecured, 1=secured).

**OS302, Series C, FRN 11  
OS401, Series C, FRN 11  
OS501, Series C, FRN 11  
released: June 2008**

## **Enhancements**

- Modbus RTU Master capability on RS232 Channel 0

Modbus RTU Master capability is added to RS232 Channel 0 communication.

Modbus Message commands supported:

- 01 Read Coil Status
  - 02 Read Input Status
  - 03 Read Holding Registers
  - 04 Read Input Registers
  - 05 Force (Write) Single Coil (Latch/Unlatch)
  - 06 Preset (Write) Single Register
  - 15 Force (Write) Multiple Coils
  - 16 Preset (Write) Multiple Registers
  - "Force" and "Preset" are presented as "Write"
- PID Rational Approximation enhancement
- Added rational approximation method for better calculation accuracy. This bit is disabled by default so as to maintain existing program behavior when upgrading from previous FRN. For the new design, enable Rational Approximation method by setting Word 0, bit 14 to '1' in the PID control block.

**Notes:**



## SLC Status File

This appendix lists the:

- SLC processor status file overview
- status file detailed word/bit descriptions

This appendix discusses the status file functions of the Fixed, SLC 500, SLC 5/01, SLC 5/02, SLC 5/03, SLC 5/04 and SLC 5/05 processors. The processors function similarly, but the higher numbered processors utilize more features. The tables in this appendix indicate which functions are supported by each processor.

The appendix starts with an overview listing of the status file. A more detailed description of each status word follows. Use the overview list to find the page number of the detailed description.

### Status File Overview

The status file lets you monitor how your operating system works and lets you direct how you want it to work. This is done by using the status file to set up interrupts, load memory module programs, and monitor both hardware and software faults.

**TIP**

Do not write to status file data unless the word or bit is listed as dynamic/static configuration in the descriptions that follow. If you intend writing to status file data, it is imperative that you first understand the function fully.

The status file contains the following words:

**Table B.1 Status File Location**

<b>Word</b>	<b>Function</b>	<b>Applies To</b>	<b>Page</b>
S:0	Arithmetic and Scan Status Flags	<b>all processors</b>	B-5
S:1	Processor Mode Status/Control		B-6
S:2	Processor Alternate Mode Status/Control		B-13
S:3L	Current Scan Time		B-19
S:3H	Watchdog Scan Time		B-20
S:4	Free Running Clock		B-21
S:5	Minor Error Bits		B-21
S:6	Major Error Fault Code		B-26
S:7, S:8	Suspend Code/Suspend File		B-35
S:9	DH-485 Active Nodes (Fixed, SLC 5/01, SLC 5/02) Channel 1 Active Nodes (SLC 5/03) Unused (SLC 5/04) Ethernet Daughterboard Firmware Series (SLC 5/05)		B-35
S:10	DH-485 Active Nodes (Fixed, SLC 5/01, SLC 5/02) Channel 1 Active Nodes (SLC 5/03) Unused (SLC 5/04) Ethernet Daughterboard Firmware Revision (SLC 5/05)		B-35
S:11, S:12	I/O Slot Enables		B-36
S:13, S:14	Math Register		B-37
S:15L	DH-485 Node Address (Fixed, SLC 5/01, SLC 5/02) Channel 1 DH-485 Node Address (SLC 5/03) Channel 1 DH+ Node Address (SLC 5/04) Ethernet Daughterboard Fault Code (SLC 5/05)		B-38
S:15H	DH-485 Baud Rate (Fixed, SLC 5/01, SLC 5/02) Channel 1 DH-485 Baud Rate (SLC 5/03) Channel 1 DH+ Baud Rate (SLC 5/04) Ethernet Daughterboard Fault Code (SLC 5/05)		B-39

**Table B.1 Status File Location (Continued)**

<b>Word</b>	<b>Function</b>	<b>Applies To</b>	<b>Page</b>
S:16, S:17	Word Single Step Rung/File	<b>SLC 5/02 and higher</b>	B-40
S:18, S:19	Single Step Breakpoint Rung/File		B-40
S:20, S:21	Word Fault Powerdown Rung/File		B-41
S:22	Maximum Observed Scan Time		B-42
S:23	Average Scan Time		B-42
S:24	Index Register		B-43
S:25, S:26	I/O Interrupt Pending		B-43
S:27, S:28	I/O Interrupt Enabled		B-44
S:29	User Fault Routine File Number		B-44
S:30	Selectable Timed Interrupt Set Point		B-45
S:31	Selectable Timed Interrupt File Number		B-45
S:32	I/O Interrupt Executing		B-46
S:33	Extended Processor Status and Control		<b>SLC 5/03 and higher</b>
S:34	Processor Extended Mode Status/Control	B-51	
S:35	Last 1 ms Scan Time	B-52	
S:36	Extended Minor Error Bits Reserved	B-52	
S:37	Clock/Calendar Year	B-53	
S:38	Clock/Calendar Month	B-53	
S:39	Clock/Calendar Day	B-54	
S:40	Clock/Calendar Hours	B-54	
S:41	Clock/Calendar Minutes	B-54	
S:42	Clock/Calendar Seconds	B-54	
S:43	Selectable Timed Interrupt Time	B-54	
S:44	I/O Event Interrupt Time	B-54	
S:45	Discrete Input Interrupt Time	B-54	
S:46	Discrete Input Interrupt File Number	B-55	
S:47	Discrete Input Interrupt Input Slot	B-55	
S:48	Discrete Input Interrupt Bit Mask	B-55	
S:49	Discrete Input Interrupt Compare Value	B-56	
S:50	Discrete Input Interrupt Down Count	B-56	
S:51	Discrete Input Interrupt Return Mask	B-56	
S:52	Discrete Input Interrupt Accumulator	B-56	
S:53L	Day-of-Week (SLC 5/03 OS302 Series B and higher, SLC 5/04 OS401 Series B and higher, and SLC 5/05)	B-57	
S:53H	Reserved	B-57	

**Table B.1 Status File Location (Continued)**

Word	Function	Applies To	Page
S:54	Last Major Error Fault Code	<b>SLC 5/03 and higher</b>	B-57
S:55	Last DII ISR Scan Time		B-57
S:56	Maximum DII ISR Scan Time		B-57
S:57	Operating System Catalog Number		B-57
S:58	Operating System Series		B-57
S:59	Operating System FRN		B-57
S:60	Processor Catalog Number		B-57
S:61	Processor Series		B-58
S:62	Processor Revision		B-58
S:63	User Program Type		B-58
S:64	User Program Functionality Index		B-58
S:65	User RAM Size		B-58
S:66	Flash EEPROM Size		B-58
S:67 to S:82	Channel 0 Active Node Table		B-58
S:83 to S:86	Channel 1 Active Node Table		<b>SLC 5/04</b>
S:87 to S:98	Reserved	B-59	
S:99	Global Status Word	B-59	
S:100 to S:163	Global Status File	B-59	

## Status File Details

## Conventions Used in the Displays

The following tables describe the status file functions, beginning at address S:0 and ending at address S:163. A bullet (•) indicates that the function applies to the specified processor.

The following classifications are used:

- **Status** - Use these words, bytes, or bits to monitor processor options or processor status information. The information is seldom written to the user program or programming device (unless you want to reset or clear a function such as a minor error bit).
- **Dynamic Configuration** - Use these words, bytes, or bits to select processor options while in the RUN mode.
- **Static Configuration** - Use these words, bytes, or bits to select processor options prior to entering the RUN mode. Note that some options must be selected while in the offline program mode, prior to restoring the user program.

**Table B.2 Status File Functions**

Address	Classification	Description	Fixed 5/01	5/02	5/03	5/04	5/05
<b>S:0</b>		<p><b>Arithmetic and Scan Status Bits</b></p> <p>The arithmetic flags are assessed by the processor following the execution of any math, logical, or move instruction. The state of these bits remains in effect until the next math, logical, or move instruction in the program is executed.</p>	•	•	•	•	•
<b>S:0/0</b>	<b>Status</b>	<p><b>Carry Bit</b></p> <p>This bit is set by the processor if a mathematical carry or borrow is generated. Otherwise the bit remains cleared. This bit is assessed as if a function of unsigned math.</p>	•	•	•	•	•
		<p>When a STI, I/O Slot, or Fault Routine interrupts normal execution of your program, the original value of S:0/0 is restored when execution resumes.</p>		•	•	•	•
		<p>When a DII interrupts normal execution of your program, the original value of S:0/0 is restored when execution resumes.</p>			•	•	•
<b>S:0/1</b>	<b>Status</b>	<p><b>Overflow Bit</b></p> <p>This bit is set by the processor when the result of a mathematical operation does not fit in its destination. Otherwise the bit remains cleared. Whenever this bit is set, the overflow trap bit S:5/0 is also set. Refer to S:5/0.</p>	•	•	•	•	•
		<p>When a STI, I/O Slot, or Fault Routine interrupts normal execution of your program, the original value of S:0/1 is restored when execution resumes.</p>		•	•	•	•
		<p>When a DII interrupts normal execution of your program, the original value of S:0/1 is restored when execution resumes.</p>			•	•	•
<b>S:0/2</b>	<b>Status</b>	<p><b>Zero Bit</b></p> <p>This bit is set by the processor when the result of a math, logical, or move instruction is zero. Otherwise the bit remains cleared.</p>	•	•	•	•	•
		<p>When a STI, I/O Slot, or Fault Routine interrupts normal execution of your program, the original value of S:0/2 is restored when execution resumes.</p>		•	•	•	•
		<p>When a DII interrupts normal execution of your program, the original value of S:0/2 is restored when execution resumes.</p>			•	•	•

**Table B.2 Status File Functions (Continued)**

Address	Classification	Description	Fixed 5/01	5/02	5/03	5/04	5/05
S:0/3	Status	<b>Sign Bit</b>  This bit is set by the processor when the result of a math, logical, or move instruction is negative. Otherwise the bit remains cleared.	•	•	•	•	•
		When a STI, I/O Slot, or Fault Routine interrupts normal execution of your program, the original value of S:0/3 is restored when execution resumes.		•	•	•	•
		When a DII interrupts normal execution of your program, the original value of S:0/3 is restored when execution resumes.			•	•	•
S:0/4 to S:0/15	NA	<b>Reserved</b>	•	•	•	•	•
S:1/0 to S:1/4	Status	<b>Processor Mode Status/Control</b>  Bits 0-4 function as follows:	•	•	•	•	•
		0 0000 = (0) Remote Download in progress.					
		0 0001 = (1) Remote Program mode (the fault mode exists when bit S:1/13 is set along with mode 0 0001)					
		0 0011 = (3) Suspend Idle (operation halted by SUS instruction execution) fault mode exists when bit S:1/13 is set along with mode 0 0011.					
		0 0110 = (6) Remote Run mode					
		0 0111 = (7) Remote Test continuous mode					
		0 1000 = (8) Remote Test single scan mode					
		0 1001 = (9) Remote Test single step (step until)					
	<b>TIP</b>	All modes in the fixed, SLC 5/01, and SLC 5/02 processors are considered as remote because they do not have a keyswitch.					
1 0001 = (17) PROGram mode - the fault mode exists when bit S:1/13 is set along with mode 1 0001.							
1 1011 = (27) Suspend Idle - the fault mode exists when bit S:1/13 is set along with mode 1 1011 (keyswitch=RUN)							
1 1110 = (30) RUN - the fault mode exists when bit S:1/13 is set along with mode 1 1110 (keyswitch=RUN).							
All other values for bits 0-4 are reserved.							
S:1/5	Status	<b>Forces Enabled Bit</b>  This bit is set by the processor if you have enabled forces in a ladder program. Otherwise, the bit remains cleared. The processor Forced I/O LED is on continuously when forces are enabled.	•	•	•	•	•

**Table B.2 Status File Functions (Continued)**

<b>Address</b>	<b>Classification</b>	<b>Description</b>	<b>Fixed 5/01</b>	<b>5/02</b>	<b>5/03</b>	<b>5/04</b>	<b>5/05</b>
<b>S:1/6</b>	<b>Status</b>	<p><b>Forces Installed Bit</b></p> <p>This bit is set by the processor if you have installed forces in a ladder program. The forces may or may not be enabled. Otherwise the bit remains cleared. The processor Forced I/O LED flashes when forces are installed, but not enabled.</p>	•	•	•	•	•
<b>S:1/7</b>	<b>Status</b>	<p><b>Communications Active Bit (Channel 1)</b></p> <p>This bit is set by the processor when at least one other node is present on the network attached to channel 1. Otherwise, the bit remains cleared. When the node is active, it is a recognized participant in a DH-485 or DH+ token-passing network. For Ethernet communications, this bit is only an indication that the Ethernet daughter board is functioning properly, not necessarily that there are any other active Ethernet nodes, or that channel 1 is connected to an Ethernet network.</p>	•	•	•	•	•
<b>S:1/8</b>	<b>Dynamic Config</b>	<p><b>Fault Override at Powerup Bit</b></p> <p>When set, this bit causes the processor to clear the Major Error Halted bit S:1/13 and Minor error bits S:5/0 to S:5/7 on power up; if the processor had previously been in the REM Run mode and had faulted. The processor then attempts to enter the REM Run mode. When this bit remains cleared (default value), the processor remains in a major fault state at power up. To program this feature, set this bit using the Data Monitor function.</p>	•	•	•	•	•
<b>S:1/9</b>	<b>Dynamic Config</b>	<p><b>Startup Protection Fault Bit</b></p> <p>When this bit is set and power is cycled while the processor is in the REM Run mode, the processor executes your fault routine prior to the execution of the first scan of your program. You then have the option of clearing the Major Error Halted bit S:1/13 to resume operation in the REM Run mode. If your fault routine does not reset bit S:1/13, the fault mode results.</p> <p>To program this feature, use the Data Monitor function, then program your fault routine logic accordingly. When executing the startup protection fault routine, S:6 (major error fault code) will contain the value 0016H.</p>		•	•	•	•

**Table B.2 Status File Functions (Continued)**

Address	Classification	Description	Fixed 5/01	5/02	5/03	5/04	5/05
S:1/10	<p><b>Static Config</b></p> <p>(See table on page B-60 for all setting combinations.)</p>	<p><b>Load Memory Module on Memory Error Bit</b></p> <p>You can use this bit to transfer a memory module program to the processor in the event that a processor memory error is detected at power-up. A memory error means the processor cannot run the program in the RAM because the program has been corrupted, as detected by a parity or checksum error. This type of error is caused by battery or capacitor drain, noise, or a power problem.</p> <p>You must set S:1/10 in the status file of the program in the memory module. When a memory module is installed that has bit S:1/10 set, a processor memory error detected at power-up causes the memory module program to be transferred to the processor, and the REM Run mode to be entered.</p> <p>When S:1/10 is cleared in the memory module, the processor remains in a major fault condition if a memory error is detected on power-up, regardless if a memory module exists.</p> <p>When S:1/10 is set in the status file of the user program in RAM memory, the memory module must be installed at all times to enter the REM Run or REM Test modes.</p> <p>To program this feature, set this bit using the Data Monitor function. Then store the program in the memory module.</p>	•	•	•	•	•



**Table B.2 Status File Functions (Continued)**

Address	Classification	Description	Fixed 5/01	5/02	5/03	5/04	5/05	
S:1/11	Static Config  (See table on page B-60 for all setting combinations.)	<b>Load Memory Always Bit</b>		•	•	•	•	
		When this bit is set, you can overwrite a processor program with a memory module program by cycling processor power. A programming device is not required. The processor mode after powerup is as follows for SLC 5/02 and higher processors:						
		<b>Mode before Powerdown</b>   <b>Mode after Powerup</b>						
		REM Test/Program REM Run Fault after REM Test/Program Fault after REM Run REM Idle REM Download	REM Program REM Run REM Program REM Run REM Program REM Program					
		<b>Mode before Powerdown</b>   <b>Mode after Powerup (same keyswitch position)</b>						
Run Program Idle Fault after Run Fault after Program	RUN PROG RUN RUN PROG			•	•	•		
<b>TIP</b>	All modes in the fixed, SLC 5/01, and SLC 5/02 processors are considered to be remote because they do not have a keyswitch.			•	•	•	•	
	The memory module you install in the processor must have status file bit S:1/11 set. Loading takes place if the master password and/or password in the processor and memory module match. Loading can also take place if the processor has neither a password nor master password.  When S:1/11 is also set in the status file of the user program in RAM, the memory module must be installed at all times to enter the REM Run or REM Test modes.							
<b>ATTENTION</b> 	The overwriting process, including data tables, is repeated each time you cycle power.							
	To program this feature, set this bit using the Data Monitor function. Then store the program in the memory module.							
	You may choose not to overwrite data files on a per file basis.				•	•	•	

**Table B.2 Status File Functions (Continued)**

Address	Classification	Description	Fixed 5/01	5/02	5/03	5/04	5/05	
S:1/12	Static Config  (See table on page B-60 for all setting combinations.)	<b>Load Memory Module and Run Bit</b>		•	•	•	•	
		With this bit, you can overwrite a processor program with a memory module program by cycling processor power. A programming device is not required. The processor will attempt to enter the REM Run mode, regardless of what mode was in effect before cycling power:			•	•	•	•
		<b>Mode before Powerdown</b>	<b>Mode after Powerup</b>					
		REM Test/Rem Program REM Run/Rem Fault REM Idle/Rem Download	REM Run REM Run REM Run					
		<b>Mode before Powerdown</b>	<b>Mode after Powerup (same keyswitch position)</b>			•	•	•
		Run Idle Program/Download Fault after Run Fault after Program	RUN Run PROGram RUN PROGram					

**Table B.2 Status File Functions (Continued)**

Address	Classification	Description	Fixed 5/01	5/02	5/03	5/04	5/05
S:1/12 continued	<b>TIP</b>	All modes in the fixed, SLC 5/01, and SLC 5/02 processors are considered to be remote because they do not have a keyswitch.		•	•	•	•
		The memory module you install in the processor must have a status file bit S:1/12 set. Loading takes place if the master password and/or password in the processor and memory module match. Loading can also take place if the processor has neither a password nor master password.  When S:1/12 is set in the status file of the user program in RAM, it does not require the presence of the memory module to enter the REM Run or REM Test mode.  <b>Application example:</b> Set both S:1/11 and S:1/12 to autoload and run every power cycle, and require the presence of the memory module to enter the REM Run or REM Test modes.					
	<b>ATTENTION</b> 	If you leave the memory module installed, the overwriting process, including data tables, is repeated each time you cycle power. The mode is changed to REM Run each and every power cycle.					
		To program this feature, use the Data Monitor function. Then store the program in the memory module. This feature is particularly useful when you are troubleshooting hardware failures with "spares" (replacement modules). Use this feature to facilitate application logic upgrades in the field without a programming device.					
		You may choose not to overwrite data files on a per file basis.			•	•	•

**Table B.2 Status File Functions (Continued)**

Address	Classification	Description	Fixed 5/01	5/02	5/03	5/04	5/05
S:1/13	Dynamic Config	<p><b>Major Error Halted Bit</b></p> <p>This bit is set by the processor any time a major error is encountered. The processor enters a fault condition. Word S:6, Fault Code will contain a code which can be used to diagnose the fault condition. Any time bit S:1/13 is set, the processor:</p> <ul style="list-style-type: none"> <li>• either places all outputs in a safe state and energizes the fault LED, or</li> </ul>	•	•	•	•	•
		<ul style="list-style-type: none"> <li>• enters the user fault routine with outputs active, allowing the fault routine ladder logic to attempt recovery from the fault condition. If your fault routine determines that recovery is required, clear S:1/13 using ladder logic prior to exiting the fault routine. If the fault routine ladder logic does not understand the fault code, or if the routine determines that it is not desirable to continue operation, exit the fault routine with bit S:1/13 set. The outputs will be placed in a safe state and the fault LED will be energized.</li> </ul>		•	•	•	•
		<p>When you clear bit S:1/13 using a programming device, the processor mode changes from fault to either Remote Program, or Remote Idle Suspend depending on the previous mode of the processor. You can move a value to S:6, then set S:1/13 in your ladder program to generate an application specific Major Error.</p>	•	•	•	•	•
	<p><b>TIP</b></p> <p>Once a major fault state exists, you must correct the condition causing the fault, and you must also clear this bit in order for the processor to accept a mode change attempt (into REM Program, REM Run, or REM Test). Also, clear S:6 to avoid the confusion of having an error code but no fault condition.</p>						
	<p><b>TIP</b></p> <p>Do not re-use error codes that are defined in the SLC error code list in chapter as application specific error codes. Instead, create your own unique codes. This prevents you from confusing application errors with system errors. We recommend using error codes FFO0 to FFOF to indicate application specific major errors.</p>						
	<p>When you clear bit S:1/13 using a programming device, the processor mode changes from fault to either Program, Run, or Idle Suspend depending on the previous mode of the processor. You can move a value to S:6, then set S:1/13 in your ladder program to generate an application specific major error.</p>			•	•	•	
	<p><b>ATTENTION</b></p> <p>If you clear this bit with the keyswitch in RUN, the processor immediately enters the RUN mode.</p> 						
	<p>You can clear faults S:1/13 and S:6 by cycling the keyswitch to PROGram and then to RUN</p>						

Table B.2 Status File Functions (Continued)

Address	Classification	Description	Fixed 5/01	5/02	5/03	5/04	5/05
S:1/14	Status	<p><b>Access Denied Bit (OEM Lock)</b></p> <p>You can allow or deny future access to a processor file. Set this bit to deny access. This indicates that a programming device must have a matching copy of the processor file in its memory in order to monitor the ladder program. A programming device that does not have a matching copy of the processor file is denied access.</p> <p>To program this feature, select "Future Access Disallow" when saving your program. To provide protection from inadvertent data monitor alteration of your selection, program an unconditional OTL instruction at address S:1/14, to deny future access. Program an unconditional OTU instruction at address S:1/14 to allow future access.</p> <p>When this bit is cleared, it indicates that any compatible programming device can access the ladder program (provided that password conditions are satisfied).</p> <p>When access is denied, the programming device (APS or HHT) may not access the ladder program. Functions such as change mode, clear memory, restore program, and transfer memory module are allowed regardless of this selection. A device such as the DTAM is not affected by this function.</p>	•	•	•	•	•
S:1/15	Status	<p><b>First Pass Bit</b></p> <p>Use this bit to initialize your program as the application requires. When this bit is set by the processor, it indicates that the first scan of the user program is in progress (following power up in the RUN mode or entry into a REM Run or REM Test mode). The processor clears this bit following the first scan.</p> <p>When this bit is cleared, it indicates that the program is not in the first scan of a REM Test or REM Run mode.</p> <p>This bit is set during execution of the startup protection fault routine. Refer to S:1/9 for more information.</p>	•	•	•	•	•
				•	•	•	•
S:2/0	Status	<p><b>STI (Selectable Timed Interrupt) Pending Bit</b></p> <p>When set, this bit indicates that the STI timer has timed out and the STI routine is waiting to be executed. This bit is cleared upon starting of the STI routine, power up, exit of the REM Run mode, or execution of a true STS instruction.</p> <p>The STI pending bit will not be set if the STI timer expires while executing the fault routine.</p> <p>This bit is set if the STI timer expires while executing the DII subroutine or fault routine.</p>		•	•	•	•
				•			
					•	•	•

**Table B.2 Status File Functions (Continued)**

Address	Classification	Description	Fixed 5/01	5/02	5/03	5/04	5/05
S:2/1	<b>Static Config</b>	<p><b>STI (Selectable Timed Interrupt) Enabled Bit</b></p> <p>This bit is set in its default condition, or when set by the STE or STS instruction. If set, it allows execution of the STI if the STI file (S:31) and STI setpoint (S:30) are non-zero. If clear, when an interrupt occurs, the STI subroutine does not execute and the STI Pending bit is set. The STI Timer continues to run when disabled. The STD instruction clears this bit.</p>		•	•	•	•
	<b>Dynamic Config</b>	<p>Use the Data Monitor function to set and clear this bit, or address this bit with your ladder logic program. This bit is set in its default condition, or when set by the STE or STS instruction. If set, it allows execution of the STI if the STI file (word 31) and STI rate (word 30) are non-zero. If clear, the STI subroutine does not execute and the STI pending bit is set. The STI timer continues to run. The STD instruction clears this bit.</p>			•	•	•
S:2/2	<b>Status</b>	<p><b>STI (Selectable Timed Interrupt) Executing Bit</b></p> <p>When set, this bit indicates that the STI timer has timed out and the STI subroutine is currently being executed. This bit is cleared upon completion of the STI routine, powerup, or REM Run mode entry.</p> <p><b>Application example:</b> You can examine this bit in your fault routine to determine if your STI was executing when the fault occurred.</p>		•	•	•	•
S:2/3	<b>Static Config</b>	<p><b>Index Addressing File Range Bit</b></p> <p>When clear, the index register can only index within the same data file of the specified base address. When set, the index register can index anywhere from data file B3:0 to the end of the last declared data file. This bit is selected at the time you save your program.</p>		•	•	•	•
		<p>The SLC 5/03 and higher processors allow you to index from 0:0 to the last data file.</p>			•	•	•
	<b>TIP</b>	<p>Change this bit while in the offline mode only. Save the program after changing the bit.</p>					
S:2/4	<b>Static Config</b>	<p><b>Saved with Single Step Test Enabled Bit</b></p> <p>When clear, the Single Step Test mode function is not available. Clear also indicates that debug registers S:16 through S:21 are inoperative. When set, the program can operate in the Single Step Test mode. See descriptions of S:16 through S:21. When set, your program requires 0.375 instruction words (3 bytes) per rung of additional memory. This bit is selected at the time you save your program.</p>		•			
	<b>TIP</b>	<p>This bit is not applicable to the SLC 5/03 and higher processors since its functionality is always available and requires no special compile time selection.</p>			•	•	•

**Table B.2 Status File Functions (Continued)**

Address	Classification	Description	Fixed 5/01	5/02	5/03	5/04	5/05
S:2/5	Status	<p><b>Incoming Command Pending Bit (Channel 1)</b></p> <p>This bit is set when the processor determines that another node on the network has requested information or supplied a command to it. This bit can be set at any time. This bit is cleared when the processor services the request (or command).</p> <p>Use this bit as a condition of an SVC instruction to enhance the communication capability of your processor.</p>		•	•	•	•
S:2/6	Status	<p><b>Message Reply Pending Bit (Channel 1)</b></p> <p>This bit is set when another node on the network has supplied the information you requested in the MSG instruction of your processor. This bit is cleared when the processor stores the information and updates your MSG instruction.</p> <p>Use this bit as a condition of an SVC instruction to enhance the communication capability of your processor.</p>		•	•	•	•
S:2/7	Status	<p><b>Outgoing Message Command Pending Bit (Channel 1)</b></p> <p>This bit is set when one or more messages in your program are enabled and waiting, but no message is being transmitted at the time. As soon as transmission of a message begins, the bit is cleared. After transmission, the bit is set again if there are further messages waiting. It remains cleared if there are no further messages waiting.</p> <p>Use this bit as a condition of an SVC instruction to enhance the communication capability of your processor.</p>		•	•	•	•
S:2/8	Dynamic Config	<p><b>CIF (Common Interface File) Addressing Mode</b></p> <p>This bit controls the mode used to address elements in the CIF file (data file 9) when processing a communication request.</p> <p>Word address mode - in effect when the bit is clear (0): This is the default setting, compatible with other SLC 500 devices on the DH-485 network.</p> <p>Byte address mode - in effect when the bit is set (1): This mode is used when the processor is receiving a message from a device on the network, possibly through a bridge or gateway. This setting is compatible with Allen-Bradley PLC inter-processor communication.</p>		•	•	•	•

**Table B.2 Status File Functions (Continued)**

Address	Classification	Description	Fixed 5/01	5/02	5/03	5/04	5/05
S:2/9	Static Config	<p><b>Memory Module Program Compare</b></p> <p>When this bit is set inside a valid program that is contained in a memory module, no modification of the NVRAM user program files is allowed. This includes online editing, program downloading, and clear memory commands. Use this feature to prevent a programming device from altering the NVRAM program from the program contained in the Memory Module. If a memory module is installed with this bit set, and a different NVRAM user program is contained in NVRAM, the processor will not enter the Run mode. You must transfer the memory module program to NVRAM in order to enter the Run mode.</p>			•	•	•
S:2/10	Static Config	<p><b>STI Resolution Selection (1 ms or 10 ms) Bit</b></p> <p>This bit is cleared by default. When clear, this bit uses a 10 ms timebase for the STI Setpoint (S:30) value. For example, the value 4 uses a 40 ms STI setpoint. When set, this bit uses a 1 ms timebase for the STI Setpoint (S:30). For example, the value 4 uses a 4 ms STI setpoint. To program this feature, use the Data Monitor function to set, clear, or address this bit with your ladder program.</p>			•	•	•
S:2/11	Status	<p><b>Discrete Input Interrupt Pending Bit</b></p> <p>When set, this bit indicates that the DII accumulator (S:52) equals the DII preset (S:50) and the ladder file number specified by the DII file number (S:46) is waiting to be executed. It is cleared when the DII file number (S:46) begins executing, or on exit of the REM Run or REM Test mode.</p>			•	•	•
S:2/12	Dynamic Config	<p><b>Discrete Input Interrupt Enabled Bit</b></p> <p>To program this feature, use the Data Monitor function to set, clear, or address this bit with your ladder program. This bit is set in its default condition. If set, it allows execution of the DII Subroutine if the DII file (S:46) is non-zero. If clear, when the interrupt occurs, the DII subroutine does not execute and the DII Pending bit is set. The DII function continues to run anytime the DII file (S:46) is non-zero. If the pending bit is set, the enable bit is examined at the next end of scan.</p>			•	•	•
S:2/13	Status	<p><b>Discrete Input Interrupt Executing Bit</b></p> <p>When set, this bit indicates that the DII interrupt has occurred and the DII subroutine is currently being executed. This bit is cleared on completion of the DII routine, power up, or REM Run mode entry.</p> <p><b>Application example:</b> You can examine this bit in your fault routine to determine if your DII was executing when the fault occurred.</p>			•	•	•



**Table B.2 Status File Functions (Continued)**

Address	Classification	Description	Fixed 5/01	5/02	5/03	5/04	5/05
S:2/14	Dynamic Config	<p><b>Math Overflow Selection Bit</b></p> <p>Set this bit when you intend to use 32-bit addition and subtraction. When S:2/14 is set, and the result of an ADD, SUB, MUL, or DIV instruction cannot be represented in the destination address (underflow or overflow),</p> <ul style="list-style-type: none"> <li>the overflow bit S:0/1 is set,</li> <li>the overflow trap bit S:5/0 is set, and</li> <li>the destination address contains the unsigned truncated least significant 16 bits of the result</li> </ul> <p>The default condition of S:2/14 is reset (0). When S:2/14 is reset, and the result of an ADD, SUB, MUL, or DIV instruction cannot be represented in the destination address (underflow or overflow),</p> <ul style="list-style-type: none"> <li>the overflow bit S:0/1 is set,</li> <li>the overflow trap bit S:5/0 is set, and</li> <li>the destination address contains 32767 if the result is positive or - 32768 if the result is negative.</li> </ul>		•	•	•	•
		<p><b>TIP</b> The status of bit S:2/14 has no effect on the DDV instruction. Also, it has no effect on the math register content when using MUL and DIV instructions.</p>					
		<p>To program this feature, use the Data Monitor function to set or clear this bit. To provide protection from inadvertent data monitor alteration of your selection, program an unconditional OTL instruction at address S:2/14 to ensure the new math overflow operation. Program an unconditional OTU instruction at address S:2/14 to ensure the original math overflow operation.</p> <p>See page 4-7 in this manual for an application example of 32-bit signed math.</p>					

**Table B.2 Status File Functions (Continued)**

Address	Classification	Description	Fixed 5/01	5/02	5/03	5/04	5/05
S:2/15	Dynamic Config	<p><b>Communications Servicing Selection Bit</b>  <b>(Ethernet Channel 1 for SLC 5/05)</b>  <b>(DH+ Channel 1 for SLC 5/04)</b>  <b>(DH-485 Channel 1 for SLC 5/03)</b></p> <p>When set, only one communication request/command can be serviced per END, TND, REF, or SVC. When clear, all serviceable incoming or outgoing communication requests/commands can be serviced per END, TND, REF, or SVC. When clear, communication throughput increases. However, your scan time will increase if several communication requests/commands are received in the same scan.</p> <p>One communication request/command consists of either an incoming command, a message reply, or an outgoing message command. See S:2/5, S:2/6, and S:2/7 and S:33/7.</p> <p>To program this feature, use the Data Monitor function to set or clear this bit. To provide protection from inadvertent data monitor alteration of your selection, program an unconditional OTL instruction at address S:2/15 to ensure one request/command operation, or program an unconditional OTU instruction at address S:2/15 to ensure multiple request/command operation. Alternately, your program may change the state of this bit using ladder logic if your application requires dynamic selection of this function.</p> <p><b>Application example:</b> Suppose you have a system consisting of an SLC 5/03 processor, programming software, and a DTAM. The program scan time for your user program is extremely long. Because of this, the programming device or DTAM takes an unusually long time to update its screen. Improve this update time by clearing S:2/15.</p> <p>In a case such as this, the additional time spent by the processor to service all communication at the end of the scan is insignificant compared to the time it takes to complete one scan. You could increase communication throughput even further by using an SVC instruction. See page 12-3 in this manual for more information.</p>		•	•	•	•

**Table B.2 Status File Functions (Continued)**

Address	Classification	Description	Fixed 5/01	5/02	5/03	5/04	5/05
S:3L	Status	<p><b>Current/Last 10 ms Scan Time</b></p> <p>The value of this byte tells you how much time elapses in a program cycle. A program cycle includes:</p> <ul style="list-style-type: none"> <li>• scanning the ladder program,</li> <li>• housekeeping,</li> <li>• scanning the I/O, and</li> <li>• servicing of the communication port.</li> </ul> <p>The byte value is zeroed by the processor each scan, immediately preceding the execution of rung 0 of program file 2 (main program file) or on return from the REF instruction. The byte is incremented every 10 ms thereafter, and indicates, in 10 ms increments, the amount of time elapsed in each program cycle. If this value ever equals the value in S:3H Watchdog, a user watchdog major error will be declared (code 0022).</p> <p>The resolution of the scan time value is +0 to -10 ms. Example: The value 9 indicates that 80-90 ms has elapsed since the start of the program cycle.</p>	•	•			
	<b>TIP</b>	When SVC or REF instructions are contained in your program, this value will appear to be erratic when you monitor it with a programming device. This is because the SVC or REF instructions allow this value to be read in mid-scan, while it is still incrementing.		•	•	•	•

**Table B.2 Status File Functions (Continued)**

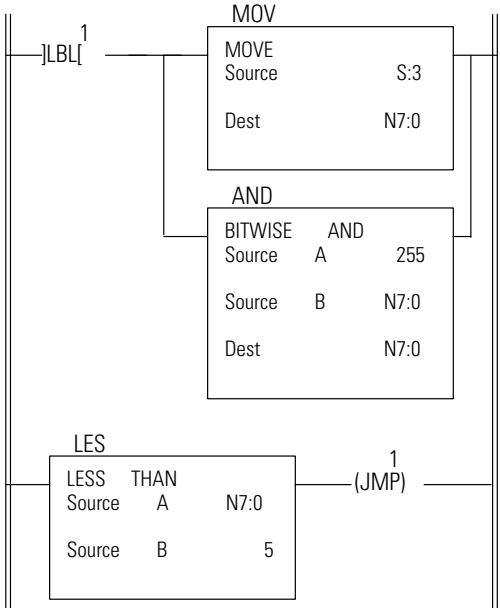
Address	Classification	Description	Fixed 5/01	5/02	5/03	5/04	5/05
S:3L continued		<p><b>Application example:</b> Your application requires that each and every program scan execute in the same length of time. You measure the maximum and minimum scan times and find them to be 40 ms and 20 ms.</p> <p>You can make every scan equal to precisely 50 ms by programming the following rungs as the last rungs of your program.</p>  <p>This example assumes that your I/O scan and communication servicing takes less than 10 ms. If it exceeds 10 ms, the resolution of +0 to -1 tick (10 ms) must be added to the scan time.</p>					
S:3H	Dynamic Config	<p><b>Watchdog Scan Time Byte</b></p> <p>This byte value contains the number of 10 ms ticks allowed to occur during a program cycle. The default value is 10 (100 ms), but you can increase this to 250 (2.5 seconds) or decrease it to 2, as your application requires. If the program scan S:3L value equals the watchdog value, a watchdog major error will be declared (code 0022). This value is applied each END, TND, or REF.</p>	•	•	•	•	•

**Table B.2 Status File Functions (Continued)**

Address	Classification	Description	Fixed 5/01	5/02	5/03	5/04	5/05
S:4	<b>Status</b>	<p><b>Free Running Clock</b></p> <p>Only the first 8 bits (byte value) of this word are assessed by the processor. This value is zeroed at powerup in the REM Run mode.</p> <p>You can use any individual bit of this byte in your user program as a 50% duty cycle clock bit. Clock rates for S:4/0 to S:4/7 are: 20, 40, 80, 160, 320, 640, 1280, and 2560 ms.</p> <p>The application using the bit must be evaluated at a rate more than two times faster than the clock rate of the bit. This is illustrated in the following example for SLC 5/02 and higher processors.</p>	•				
	<b>Dynamic Config</b>	All 16 bits of this word are assessed by the processor. The value of this word is zeroed upon power up in the REM Run mode or entry into the REM Run or REM Test mode. It is incremented every 10 ms thereafter.		•	•	•	•
	<b>TIP</b>	You can write any value to S:4. It will begin incrementing from this value.					
		<p>You can use any individual bit of this word in your user program as a 50% duty cycle clock bit. Clock rates for S:4/0 to S:4/15 are:</p> <p>20, 40, 80, 160, 320, 640, 1280, 2560, 5120, 10240, 20480, 40960, 81920, 163840, 327680, and 655360 ms</p> <p>The application using the bit must be evaluated at a rate more than two times faster than the clock rate of the bit. In the following example, bit S:4/3 toggles every 80 ms, producing a 160 ms clock rate. To maintain accuracy of this bit in your application, the instruction using bit S:4/3 (O:1/0 in this case) must be evaluated at least once every 79.999 ms.</p> <div style="text-align: center;"> <p style="text-align: center;">S:4/3 cycles in 160 ms</p> <p style="text-align: center;">Both S:4/3 and Output O:1/0 toggle every 80 ms. O:1/0 must be evaluated at least</p> </div>					
S:5		<p><b>Minor Error Bits</b></p> <p>The bits of this word are set by the processor to indicate that a minor error has occurred in your ladder program. Minor errors, bits 0 to 7, revert to major error 0020H if any bit is detected as being set at the end of the scan. HHT users: If the processor faults for error code 0020H, you must clear minor error bits S:5/0-7 along with S:1/13 to attempt error recovery.</p>	•	•	•	•	•

**Table B.2 Status File Functions (Continued)**

Address	Classification	Description	Fixed 5/01	5/02	5/03	5/04	5/05
S:5/0	Dynamic Config	<p><b>Overflow Trap Bit</b></p> <p>When this bit is set by the processor, it indicates that a mathematical overflow has occurred in the ladder program. See S:0/1 for more information.</p> <p>If this bit is ever set upon execution of the END, TND, or REF instruction, major error (0020) will be declared. To avoid this type of major error from occurring, examine the state of this bit following a math instruction (ADD, SUB, MUL, DIV, DDV, NEG, SCL, TOD, or FRD), take appropriate action, and then clear bit S:5/0 using an OTU instruction with S:5/0 or a CLR instruction with S:5.</p>	•	•	•	•	•
S:5/1	NA	<b>Reserved</b>	•	•	•	•	•
S:5/2	Dynamic Config	<p><b>Control Register Error Bit</b></p> <p>The LFU, LFL, FFU, FFL, BSL, BSR, SQO, SQC, and SQL instructions are capable of generating this error. When bit S:5/2 is set, it indicates that the error bit of the control instruction has been set.</p> <p>If this bit is ever set upon execution of the END, TND, or REF instruction, major error (0020) will be declared. To avoid this type of major error from occurring, examine the state of this bit following a control register instruction, take appropriate action, and then clear bit S:5/2 using an OTU instruction with S:5/2 or a CLR instruction with S:5.</p>	•	•	•	•	•
S:5/3	Dynamic Config	<p><b>Major Error Detected while Executing User Fault Routine Bit</b></p> <p>When set, the major error code (S:6) represents the major error that occurred while processing the fault routine due to another major error.</p> <p>If this bit is ever set upon execution of the END, TND, or REF instruction, major error (0020) will be declared. To avoid this type of major error from occurring, examine the state of this bit inside your fault routine, take appropriate action, and then clear bit S:5/3 using an OTU instruction with S:5/3 or a CLR instruction with S:5.</p> <p><b>Application example:</b> Suppose you are executing your fault routine for fault code 0016H Startup Protection. At rung 3 inside this fault routine, a TON containing a negative preset is executed. When rung 4 is executed, fault code 0016H is overwritten to indicate code 0034H, and S:5/3 is set.</p> <p>If your fault routine did not determine that S:5/3 was set, major error 0020H would be declared at the end of the first scan. To avoid this problem, examine S:5/3, followed by S:6, prior to returning from your fault routine. If S:5/3 is set, take appropriate action to remedy the fault, then clear S:5/3.</p>		•	•	•	•

**Table B.2 Status File Functions (Continued)**

Address	Classification	Description	Fixed 5/01	5/02	5/03	5/04	5/05
S:5/4	Dynamic Config	<p><b>M0-M1 Referenced on Disabled Slot Bit</b></p> <p>This bit is set whenever any instruction references an M0 or M1 module file element for a slot that is disabled (via its I/O slot enable bit). When set, the bit indicates that an instruction could not execute properly due to the unavailability of the addressed M0 or M1 data.</p> <p>If this bit is ever set upon execution of the END, TND, or REF instruction, major error (0020) is declared. To avoid this type of major error from occurring, examine the state of this bit following a M0-M1 referenced instruction, take appropriate action, and then clear bit S:5/4 using an OTU instruction with S:5/4 or a CLR instruction with S:5.</p>		•	•	•	•
S:5/5 to S:5/7	NA	<p><b>Reserved</b></p> <p>Reserved for minor errors that revert to major errors at the end of the scan.</p>	•	•	•	•	•
S:5/8	Status	<p><b>Memory Module Boot Bit</b></p> <p>When this bit is set by the processor, it indicates that a memory module program has been transferred to the processor. This bit is not cleared by the processor.</p> <p>Your program can examine the state of this bit on entry into the REM Run mode to determine if the memory module content has been transferred. Bit S:1/15 will be set to indicate REM Run mode entry. This information is useful when you have an application that contains retentive data and a memory module that has only bit S:1/10 set (Load Memory Module on Memory error). Use this bit to indicate that retentive data has been lost. This bit is also helpful when using bits S:1/11 (Load Memory Module Always) or S:1/12 (Load Memory Module Always and Run) to distinguish a power up REM Run mode entry from a REM Program (or REM Test) mode to REM Run mode entry.</p>	•	•	•	•	•
S:5/9	Status	<p><b>Memory Module Password Mismatch Bit</b></p> <p>This bit is set on REM Run mode entry, whenever loading from the memory module is specified (word 1, bits 11 or 12) and the processor user program is password protected, and the memory module program does not match that password.</p> <p>Use this bit to inform your application program that an autoloading memory module is installed but did not load due to a password mismatch.</p>	•	•	•	•	•
S:5/10	Status	<p><b>STI (Selectable Timed Interrupt) Overflow Bit</b></p> <p>This bit is set whenever the STI timer expires while the STI routine is either executing or disabled and the pending bit is already set.</p>		•	•	•	•

**Table B.2 Status File Functions (Continued)**

Address	Classification	Description	Fixed 5/01	5/02	5/03	5/04	5/05
S:5/11	Status	<p><b>Battery Low Bit</b></p> <p>This bit is set whenever the Battery Low LED is on. The bit is cleared when the Battery Low LED is off.</p>		•	•	•	•
S:5/12	Status	<p><b>Discrete Input Interrupt Overflow Bit</b></p> <p>This bit is set whenever the DII interrupt occurs while still executing the DII subroutine or whenever the DII interrupt occurs while pending or disabled.</p>			•	•	•
S:5/13	Dynamic Config	<p><b>Unsuccessful Operating System Load Was Attempted</b></p> <p>This bit is set whenever an operating system memory module load is attempted and is unsuccessful. Unsuccessful loads can occur when either the protection jumper is in the protect position or is missing, or if the operating system memory module is incompatible with the SLC 5/03, SLC 5/04, or SLC 5/05 processors' hardware platform. Examine the state of this bit with your user program to diagnose this condition.</p>			•	•	•
S:5/14	Status	<p><b>Channel 0 Modem Lost</b></p> <p>This bit indicates the status of the modem connected to Channel 0 (RS232 serial port). The state of the bit is determined by:</p> <ul style="list-style-type: none"> <li>• the protocol Channel 0 is configured for</li> <li>• the Control Line selected</li> <li>• the states of DCD (Data Carrier Detect) and DSR (Data Set Ready)</li> </ul> <p>If the bit is set, then the modem is not properly connected to Channel 0 or it is in a state where unreliable communication exchanges may take place via Channel 0. The following conditions apply:</p> <ul style="list-style-type: none"> <li>• If Channel 0 is disabled or configured for DH-485, the bit is always cleared.</li> <li>• If Channel 0 is configured for one of the DF1 protocols in System Mode or Generic ASCII in User Mode, then the Control Line selection determines how DCD and DSR affect the modem status: <ul style="list-style-type: none"> <li>- If Control Line = NO HANDSHAKING: The bit is always set.</li> <li>- If Control Line = FULL-DUPLEX or HALF-DUPLEX WITHOUT CONTINUOUS CARRIER: The bit is set if DSR goes inactive and cleared when DSR goes active. (DCD has no affect on modem status in this case.)</li> <li>- If Control Line = HALF-DUPLEX WITH CONTINUOUS CARRIER: The bit is set if either DSR goes inactive or DCD remains inactive for more than 10 seconds. This bit is cleared when both DSR and DCD go active.</li> </ul> </li> </ul>			•	•	•



**Table B.2 Status File Functions (Continued)**

<b>Address</b>	<b>Classification</b>	<b>Description</b>	<b>Fixed 5/01</b>	<b>5/02</b>	<b>5/03</b>	<b>5/04</b>	<b>5/05</b>
<b>S:5/15</b>	<b>Status</b>	<b>ASCII String Manipulation Error</b>  This bit applies to SLC 5/03 (OS301 and higher), SLC 5/04, and SLC 5/05 processors.  This bit is set to 1 when an attempt is made to process a string using an ASCII instruction that exceeds 82 characters in length.			•	•	•



**Table B.2 Status File Functions (Continued)**

Address	Classification	Description	Fixed 5/01	5/02	5/03	5/04	5/05						
S:6	Status	<p><b>Major Error Fault Code</b></p> <p>A hexadecimal code is entered in this word by the processor when a major error is declared. Refer to S:1/13. The code defines the type of fault, as indicated on the following pages. This word is not cleared by the processor. Error codes are presented, stored, and displayed in a hexadecimal format.</p>	•	•	•	•	•						
		<p>If you enter a fault code as a parameter in an instruction in your ladder program, you must convert the code to decimal. For example, if you program an EQU instruction to go true when the error 0016 occurs, enter S:6 as source A and 22, <i>the decimal equivalent of 0016H</i>, as source B:</p> <div style="text-align: center;"> <pre> graph LR     EQU[EQU]     A[Source A S:6] --- EQU     B[Source B 22] --- EQU     EQU --- L[ ]     EQU --- R[ ]     style L fill:none,stroke:none     style R fill:none,stroke:none             </pre> </div>		•	•	•	•						
		<p><b>Application example:</b> You can declare your own application specific major fault by writing a unique value to S:6 and then setting bit S:1/13. <i>SLC 5/02 processor users:</i> Interrogate the value of S:6 in your fault routine to determine the type of fault that occurred. If your program was saved with the test single step enabled, you can also interrogate S:20 and S:21 to pinpoint the exact rung that was executing when the fault occurred. Fault Classifications: Faults are classified as Non-User, Non-Recoverable, and Recoverable.</p>											
		<table border="1" style="width: 100%; border-collapse: collapse;"> <thead> <tr> <th style="width: 33%;">Non-User Fault</th> <th style="width: 33%;">Non-Recoverable User Fault</th> <th style="width: 33%;">Recoverable User Fault</th> </tr> </thead> <tbody> <tr> <td>The fault routine does not execute.</td> <td>The fault routine executes for 1 pass. (You may initiate a MSG instruction to another node to identify the fault condition of the processor.)</td> <td>The fault routine may clear the fault by clearing bit S:1/13.</td> </tr> </tbody> </table>	Non-User Fault	Non-Recoverable User Fault	Recoverable User Fault	The fault routine does not execute.	The fault routine executes for 1 pass. (You may initiate a MSG instruction to another node to identify the fault condition of the processor.)	The fault routine may clear the fault by clearing bit S:1/13.					
		Non-User Fault	Non-Recoverable User Fault	Recoverable User Fault									
The fault routine does not execute.	The fault routine executes for 1 pass. (You may initiate a MSG instruction to another node to identify the fault condition of the processor.)	The fault routine may clear the fault by clearing bit S:1/13.											
<p>Error code descriptions and classifications are listed on pages B-27 through B-34. Categories are:</p> <ul style="list-style-type: none"> <li>• powerup errors</li> <li>• going-to-run errors</li> <li>• runtime errors</li> <li>• user program instruction errors</li> <li>• I/O errors</li> </ul>													

**Table B.3 S:6 Error Codes**

Address	Error Code (Hex)	Errors	Fault Classification			Processor				
			Non-User	User Non-Recov	User Recov	Fixed 5/01	5/02	5/03	5/04	5/05
S:6 continued	0001	NVRAM error.	X			•	•	•	•	•
	0002	Unexpected hardware watchdog timeout.	X			•	•	•	•	•
	0003	Memory module memory error. This error can also occur while going into the REM Run mode.	X				•	•	•	•
	0004	Memory error occurred while in the Run mode.	X				•	•	•	•
	0005	Reserved			X			•	•	•
	0006	Reserved			X			•	•	•
	0007	Failure during memory module transfer.	X					•	•	•
	0008	Internal software error.	X					•	•	•
	0009	Internal hardware error.	X					•	•	•
	0010	The Processor does not meet the required revision level.	X			•	•	•	•	•
	0011	The executable program file number 2 is absent.	X			•	•	•	•	•
	0012	The ladder program has a memory error.	X			•	•	•	•	•
	0013	<ul style="list-style-type: none"> <li>• The required memory module is absent or</li> <li>• S:1/10 or S:1/11 is not set as required by the program.</li> </ul>			X	•	•	•	•	•
	0014	Internal file error.	X			•	•	•	•	•
	0015	Configuration file error.	X			•	•	•	•	•
	0016	Startup protection after power loss. Error condition exists at powerup when bit S:1/9 is set and powerdown occurred while running.			X		•	•	•	•
	0017	NVRAM/memory module user program mismatch.		X				•	•	•
	0018	Incompatible user program - Operating system type mismatch. This error can also occur during powerup.	X					•	•	•
0019	Missing or duplicate label was detected.		X				•	•	•	
001F	A program integrity problem occurred during an online editing session.	X					•	•	•	

**Table B.3 S:6 Error Codes (Continued)**

Address	Error Code (Hex)	Errors	Fault Classification			Processor					
			Non-User	User Non-Recov	Recov	Fixed 5/01	5/02	5/03	5/04	5/05	
S:6 continued	0020	A minor error bit is set at the end of the scan. Refer to S:5 minor error bits.			X	•	•	•	•	•	
	0021	Remote power failure of an expansion I/O chassis occurred.	X			•	•	•	•	•	
		<b>TIP</b>	A modular system that encounters an over-voltage or over-current condition in any of its power supplies can produce any of the I/O error codes listed on pages -32 and -34 (instead of code 0021). The over-voltage or over-current condition is indicated by the power supply LED being off.								
		<b>ATTENTION</b> 	Fixed and FRN 1 to 4 SLC 5/01 processors - If the remote power failure occurred while the processor was in the REM Run mode, error 0021 will cause the major error halted bit (S:1/13) to be cleared at the next powerup of the local chassis. SLC 5/02 processors and above and FRN 5 SLC 5/01 processors - Power to the local chassis does not need to be cycled to resume the REM Run mode. Once the remote chassis is re-powered, the CPU will restart the system.								
	0022	The user watchdog scan time has been exceeded.		X		•	•	•	•	•	
	0023	Invalid or non-existent STI interrupt file.		X			•	•	•	•	
	0024	Invalid STI interrupt interval (greater than 2559 ms or negative).		X			•	•	•	•	
	0025	Excessive stack depth/JSR calls for STI routine.		X			•	•	•	•	
	0026	Excessive stack depth/JSR calls for I/O interrupt routine.		X			•	•	•	•	
	0027	Excessive stack depth/JSR calls for user fault routine.		X			•	•	•	•	
0028	Invalid or non-existent "startup protection" fault routine file value.		X			•	•	•	•		
0029	Indexed address reference outside of entire data file space (range of B3:0 through the last file).				X		•				
	<b>ATTENTION</b> 	The SLC 5/02 processor uses an index value of zero for the faulted instruction following error recovery.									
002A	Indexed address reference is beyond specific referenced data file.		X			•	•	•	•		

**Table B.3 S:6 Error Codes (Continued)**

Address	Error Code (Hex)	Errors	Fault Classification			Processor				
			Non-User	User Non-Recov	User Recov	Fixed 5/01	5/02	5/03	5/04	5/05
<b>S:6</b> continued	<b>002B</b>	Either the file number exists, but it is not the correct file type, or the file number does not exist.			<b>X</b>			•	•	•
	<b>002C</b>	The indirectly referenced element does not exist, but the file type is correct and it exists. For example, T4:[N7:0] N7:0=10, but T4 only goes to T4:9.			<b>X</b>			•	•	•
	<b>002D</b>	Either a subelement is referenced incorrectly or an indirect reference has been made to an M-file.			<b>X</b>			•	•	•
	<b>002E</b>	Invalid DII Input slot.			<b>X</b>			•	•	•
	<b>002F</b>	Invalid or non-existent DII interrupt file.		<b>X</b>				•	•	•

*I/O Errors*

**ERROR CODES:** The characters xx in the following codes represent the slot number, in hexadecimal. If the exact slot cannot be determined, the characters xx become 1F.

**RECOVERABLE I/O FAULTS** (SLC 5/02, SLC 5/03, SLC 5/04, and SLC 5/05 processors only): Many I/O faults are recoverable. To recover, you must disable the specified slot, xx, in the user fault routine. If you do not disable slot xx, the processor will fault at the end of the scan.

**TIP**

An I/O card that is severely damaged may cause the processor to indicate that an error exists in slot 1 even though the damaged card is installed in a slot other than 1.

Slot	xx (2)	Slot	xx	Slot	xx	Slot	xx
0	00	8	08	16	10	24	18
1	01	9	09	17	11	25	19
2	02	10	0A	18	12	26	1A
3 <sup>(1)</sup>	03	11	0B	19	13	27	1B
4	04	12	0C	20	14	28	1C
5	05	13	0D	21	15	29	1D
6	06	14	0E	22	16	30	1E
7	07	15	0F	23	17	(3)	1F

(1) This value indicates that the slot was not found (500 fixed controller).

(2) Slot Numbers (xx) in hexadecimal

(3) This value indicates that the slot was not found (SLC 5/01, SLC 5/02, SLC 5/03, SLC 5/04, and SLC 5/05 processors).

**Table B.3 S:6 Error Codes**

Address	Error Code (Hex)	User Program Instruction Errors	Fault Classification			Processor				
			Non-User	User Non-Recov	User Recov	Fixed 5/01	5/02	5/03	5/04	5/05
S:6 continued	0030	Attempt was made to jump to one too many nested subroutine files. This code can also mean that a program has potentially recursive routines.		X		•	•	•	•	•
	0031	An unsupported instruction reference was detected.		X		•	•	•	•	•
	0032	A sequencer length/position parameter points past the end of a data file.			X	•	•	•	•	•
	0033	The length of LFU, LFL, FFU, FFL, BSL, or BSR instruction points past the end of a data file.			X	•	•	•	•	•
	0034	A negative value for a timer accumulator or preset value was detected.			X	•	•	•	•	•
		Fixed processors with 24 VDC inputs only: A negative or zero HSC preset was detected in a HSC instruction.			X	•				
	0035	TND, SVC, or REF instruction is called within an interrupting or user fault routine.		X			•	•	•	•
	0036	An invalid value is being used for a PID instruction parameter.			X		•	•	•	•
	0038	A RET instruction was detected in a non-subroutine file.	X			•	•	•	•	•
	xx39	Invalid string length was detected in a string file. (xx = data file number)			X			•	•	•
	003A	An attempted write to a constant data file.						•	•	•
	003B	Motherboard and Daughter Card firmware do not match.								•
	003C	STI watchdog time-out.						•	•	•
	003D	J4 jumper in wrong position.						•	•	
	005F	Invalid Rack ID						•	•	•
xx50	A chassis data error is detected. (xx = slot number)			X	•	•	•	•	•	

**Table B.3 S:6 Error Codes (Continued)**

Address	Error Code (Hex)	User Program Instruction Errors	Fault Classification			Processor				
			Non-User	User Non-Recov	User Recov	Fixed 5/01	5/02	5/03	5/04	5/05
S:6 continued	xx51	A "stuck" runtime error is detected on an I/O module. (xx = slot number)		X		•	•	•	•	•
	xx52	A module required for the user program is detected as missing or removed. (xx = slot number)			X	•	•	•	•	•
	xx53	When going-to-run, a user program declares a slot as unused, and that slot is detected as having an I/O module inserted. This can also mean that an I/O module has reset itself. (xx = slot number)			X	•	•	•	•	•
		An attempt to enter the run or test mode was made with an empty chassis.			X			•	•	•
	xx54	A module required for the user program is detected as being the wrong type. (xx = slot number)			X	•	•	•	•	•
	xx55	A discrete I/O module required for the user program is detected as having the wrong I/O count. This code can also mean that a specialty card driver is incorrect. (xx = slot number)			X	•	•	•	•	•
	0056	The chassis configuration specified in the user program is detected as being incorrect.	X			•	•	•	•	•
	xx57	A specialty I/O module has not responded to a lock shared memory command within the required time limit. (xx = slot number)			X	•	•	•	•	•
	xx58	A specialty I/O module has generated a generic fault. The card fault bit is set (1) in the module's status byte. (xx = slot number)		X		•	•	•	•	•
	xx59	A specialty I/O module has not responded to a command as being completed within the required time limit. (xx = slot number)			X	•	•	•	•	•



**Table B.3 S:6 Error Codes (Continued)**

Address	Error Code (Hex)	User Program Instruction Errors	Fault Classification			Processor				
			Non-User	User Non-Recov	User Recov	Fixed 5/01	5/02	5/03	5/04	5/05
<b>S:6</b> continued	<b>xx5A</b>	Hardware interrupt problem. (xx = slot number)		<b>X</b>			•	•	•	•
	<b>xx5B</b>	G file configuration error - user program G file size exceeds capacity of the module. (xx = slot number)			<b>X</b>		•	•	•	•
	<b>xx5C</b>	M0-M1 file configuration error - user program M0-M1 file size exceeds capacity of the module. (xx = slot number)			<b>X</b>		•	•	•	•
	<b>xx5D</b>	Interrupt service requested is not supported by the processor. (xx = slot number)			<b>X</b>		•	•	•	•
	<b>xx5E</b>	Processor I/O driver (software) error. (xx = slot number)			<b>X</b>		•	•	•	•
	<b>005F</b>	Invalid rack ID (handshake error)	<b>X</b>					•	•	•
	<b>xx60 to xx6F</b>	Identifies an I/O module specific recoverable major error. Refer to the user manual supplied with the specialty module. (xx = slot number)			<b>X</b>		•	•	•	•
	<b>xx70 to xx7F</b>	Identifies an I/O module specific non-recoverable major error. Refer to the user manual supplied with the specialty module. (xx = slot number)		<b>X</b>			•	•	•	•



**Table B.3 S:6 Error Codes (Continued)**

Address	Error Code (Hex)	User Program Instruction Errors	Fault Classification			Processor				
			Non-User	User Non-Recov	User Recov	Fixed 5/01	5/02	5/03	5/04	5/05
S:6 continued	<b>xx80 to xx8F</b>	Identifies a specialty I/O module specific major error. Refer to the user manual supplied with the specialty module. (xx = slot number)	<b>X</b>					•	•	•
	<b>xx90</b>	Interrupt problem on disabled slot.		<b>X</b>			•	•	•	•
	<b>xx91</b>	A disabled slot has faulted.		<b>X</b>			•	•	•	•
	<b>xx92</b>	An invalid or non-existent module interrupt subroutine (ISR) file.		<b>X</b>			•	•	•	•
	<b>xx93</b>	Unsupported I/O module specific major error.		<b>X</b>			•	•	•	•
	<b>xx94</b>	In the REM Run or REM Test mode, a module has been detected as being inserted under power. This can also mean that an I/O module has reset itself. (xx = slot number)		<b>X</b>			•	•	•	•
	<b>0x00A0 0x00A1 0x00A2</b>	Indicates a communications channel hardware fault has occurred. With the SLC 5/05, only the Ethernet channel (channel 1) may generate this fault. With the SLC 5/04 only the DH+ channel (channel 1) may generate this fault. Ethernet, DH+ and RS-232 communications will be disabled until a power cycle is performed. For the SLC 5/05, system status file word 15 (S:15) provides a specific fault code for the Ethernet Daughterboard.	<b>X</b>						•	•

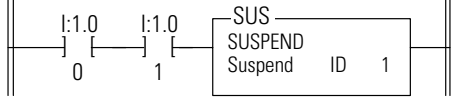
**Table B.4 Status File Functions**

Address	Classification	Description	Fixed 5/01	5/02	5/03	5/04	5/05
S:7 and S:8	Status	<p><b>Suspend Code/Suspend File</b></p> <p>When a non-zero value appears in S:7, it indicates that the SUS instruction identified by this value has been evaluated as true, and the Suspend Idle mode is in effect. This pinpoints the conditions in the application that caused the Suspend Idle mode. This value is not cleared by the processor.</p> <p>Word S:8 contains the program file number in which a true SUS instruction is located. This value is not cleared by the processor.</p> <p>Use the SUS instruction with startup troubleshooting, or as runtime diagnostics for detection of system errors.</p> <p><b>Application example:</b> You believe that limit switches connected to I:1/0 and I:1/1 cannot be energized at the same time, yet your application program acts as if they can be. To determine if you have a limit switch problem or a ladder logic problem, add the following rung to your program:</p>  <p>If your program enters the SUS Idle mode for code 1 when you run the program, you have a limit switch control problem; if the SUS Idle mode for code 1 does not occur, you have a ladder logic problem.</p>	•	•	•	•	•
S:9	Status	<p><b>Ethernet Daughter Board Firmware Series (Channel 1 - SLC 5/05 processors)</b></p> <p>A value of 1 corresponds to Series 1, for example.</p>					•
S:10	Status	<p><b>Ethernet Daughter Board Firmware Revision (Channel 1 - SLC 5/05 processors)</b></p> <p>A value of 12 corresponds to Revision 12, for example.</p>					•
S:9 and S:10	Status	<p><b>Active Nodes (Channel 1-SLC 5/03 processors)</b></p> <p>These two words are bit mapped to represent the 32 possible nodes on a DH-485 link. S:9/0 through S:10/15 represent node addresses 0-31. These bits are set by the processor when a node exists on the DH-485 link that your processor is connected to. The bits are cleared when a node is not present on the link.</p>	•	•	•		

**Table B.4 Status File Functions (Continued)**

Address	Classification	Description	Fixed 5/01	5/02	5/03	5/04	5/05
S:11 and S:12	Dynamic Config	<p><b>I/O Slot Enables</b></p> <p>These two words are bit mapped to represent the 30 possible I/O slots in an SLC 500 system. S:11/0 represents I/O slot 0 for fixed I/O systems. (Slot 0 is used for the CPU in modular systems.) S:11/1 through S:12/14 represent I/O slots 1-30. S:12/15 is unused.</p> <p>When a bit is set (default condition), it allows the I/O module contained in the reference slot to be updated in the I/O scan of the processor operating cycle.</p> <p>When you clear a bit, it causes the I/O module in the referenced slot to be ignored. That is, an I/O slot enable value of 0 causes the input image data of an input module to freeze at its last value. Also, the outputs of an output module will freeze at their last values, regardless of values contained in the output image. Outputs remain frozen until:</p> <ul style="list-style-type: none"> <li>• either power is removed,</li> <li>• the REM Run mode is exited, or</li> <li>• a major fault occurs.</li> </ul> <p>At that time the outputs are zeroed, until the slot is again enabled (set).</p> <p>Disabled slots do not have to match the user program configuration.</p>	•	•	•	•	•
	<p><b>ATTENTION</b></p> 	Make certain that you have thoroughly examined the effects of disabling (clearing) a slot enable bit before doing so in your application.					
	<p><b>TIP</b></p>	The SLC 5/02 and higher processors inform each specialty I/O module that has been disabled/enabled. Some I/O modules may perform other actions when disabled or re-enabled. Refer to the user information supplied with the specialty I/O module for possible differences from the above descriptions.		•	•	•	•
	<p><b>ATTENTION</b></p> 	<p>The DII instruction ignores the slot enable/disable status. Do not run the DII on a faulted slot. If you apply the DII on a disabled slot, the interrupt will occur. However, the input image will not reflect the present state of the card.</p> <p>This bit is applied upon detection of a DII Reconfigure bit, each DII ISR exit, and at each end of scan (END, TND, or REF).</p>			•	•	•

**Table B.4 Status File Functions (Continued)**

Address	Classification	Description	Fixed 5/01	5/02	5/03	5/04	5/05
S:13 and S:14	Status and Dynamic Config	<p><b>Math Register</b></p> <p>Use this double register to produce 32-bit signed divide and multiply operations, precision divide or double divide operations, and 5-digit BCD conversions.</p> <p>These two words are used in conjunction with the MUL, DIV, DDV, FRD, and TOD math instructions. The math register value is assessed upon execution of the instruction and remains valid until the next MUL, DIV, DDV, FRD, or TOD instruction is executed in the user program.</p> <p>An explanation of how the math register operates is included with the instruction definitions.</p> <p>If you store 32-bit signed data values, you must manage this data type without the aid of an assigned 32-bit data type. For example, combine B10:0 and B10:1 to create a 32-bit signed data value. We recommend that you keep all 32-bit signed data in a unique data file and that you start all 32-bit values on an even or odd word boundary for ease of application and viewing. Also, we recommend that you design, document, and view the contents of 32-bit signed data in either the hexadecimal or binary radix.</p>	•	•	•	•	•
		When an STI, I/O Slot, or Fault Routine interrupts normal execution of your program, the original value of the math register is restored when execution resumes. Note that S:13 and S:14 are not used when the source or destination is defined as floating point data.		•	•	•	•
		When a DII interrupts normal execution of your program, the original value of the math register is restored when execution resumes.			•	•	•

**Table B.4 Status File Functions (Continued)**

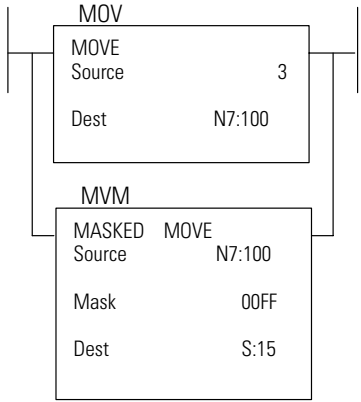
Address	Classification	Description	Fixed 5/01	5/02	5/03	5/04	5/05
S:15L	Static Config	<p><b>Node Address</b></p> <p>This byte value contains the node address of your processor on the DH-485 or DH+ link. Each device on the DH-485 link must have a unique address between the decimal values 0 and 31. Each device on the DH+ link must have a unique address between the decimal values 0 and 63. To change a processor node address, write a value between 1 and 31 for DH-485 and between 0 and 63 for DH+ using either the Data Monitor or node function of your programmer, then cycle power to the processor.</p> <p>The default node address of a processor is 1. The default DH-485 node address of HHT programmer is 0. To provide runtime protection from inadvertent data monitor alteration of your selection, program this value using an unconditional MVM instruction. Use the MOV instruction in place of MVM if you also wish to protect the baud rate. The following example show runtime protection of node address 3</p> <div style="text-align: center;">  <pre> graph TD     MOV[MOV] --- MVM[MVM]     MOV -- Source --&gt; S3[3]     MOV -- Dest --&gt; N7_100[N7:100]     MVM -- Source --&gt; N7_100     MVM -- Mask --&gt; M00FF[00FF]     MVM -- Dest --&gt; S15[S:15]     </pre> </div>	•	•	•	•	

**Table B.4 Status File Functions (Continued)**

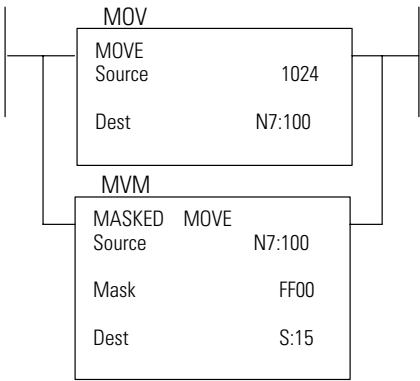
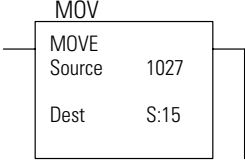
Address	Classification	Description	Fixed 5/01	5/02	5/03	5/04	5/05
S:15H	Static Config	When a configure channel command is received for channel 1, the node address is overwritten with the value contained in your channel configuration.			•	•	
		<p><b>Baud Rate</b></p> <p>This byte value contains a code used to select the baud rate of the processor on the DH-485 or DH+ link. SLC 5/01 and fixed processors provide a baud rate of 19.2K or 9.6K only. SLC 5/02 and SLC 5/03 processors provide a baud rate of 19.2K, 9.6K, 2.4K, or 1.2K. SLC 5/04 processors provide a baud rate of 57.6K, 115.2K, and 230.4K. To change the baud rate from the default values of 19.2K or 57.6K, use either the Data Monitor or baud function of your programmer. The processor uses code 1 for 1.2K, code 2 for 2.4K, code 3 for 9.6K, code 4 for 19.2 K, code 11 for 57.6K, code 12 for 115.2K, and code 13 for 230.4K baud.</p> <p>Example showing runtime protection of baud rate 19.2K (code 4):</p>  <p>S:15H equal to 4                      = 1024 decimal = 0400 hex                      = 0000 0100 0000 0000 binary</p>	•	•	•	•	
	Static Config	<p>Example showing runtime protection for both baud rate 19200 (code 4) and node address 3:</p>  <p>S:15H equal to 4 and S:15L equal to 3                      = 1027 decimal                      = 0403 hex                      = 0000 0100 0000 0011 binary</p>					
Static Config	<p>When a configure channel command is received for channel 1, the baud rate is overwritten with the value contained in your channel configuration.</p>			•	•		
Static Config	<p><b>Ethernet Daughter Board Fault Code</b></p> <p>This word value contains a fault code when an Ethernet communication channel fault occurs.</p>					•	

**Table B.4 Status File Functions (Continued)**

Address	Classification	Description	Fixed 5/01	5/02	5/03	5/04	5/05
<b>S:16 and S:17</b>	<b>Status</b>	<p><b>Test Single Step - Start Step On - Rung/File</b></p> <p>These registers indicate the executable rung (word S:16) and file (word S:17) number that the processor executes next when operating in the Test Single Step mode. To enable this feature, you must select the Test Single Step option at the time you save your program.</p> <p>These values are updated upon completion of every rung. Refer to word S:2/4 for more information. Your programming device interrogates this value when providing "start step on file x, rung y" status line information. There is no known use for this feature when addressed by your ladder program.</p>		•	•	•	•
		<p>This feature is built into the SLC 5/03 and higher processors. Selection is not required.</p>			•	•	•
<b>S:18 and S:19</b>	<b>Status and Dynamic Config</b>	<p><b>Test Single Step - Breakpoint - Rung/File</b></p> <p>These registers indicate the executable rung (word S:18) and file (word S:19) number that the processor should stop in front of when executing in the Test Single Step mode. To enable this feature, you must select the Test Single Step option at the time you save your program.</p> <p>If both the rung and file number are 0, the processor steps to the next rung only; otherwise the processor continues until it finds a rung/file equaling the S:18/S:19 value.</p> <p>The processor stops, then clears S:18 and S:19 when it finds a match, while remaining in the Test Single Step mode. The processor operates indefinitely if it cannot find the end rung/file that you have entered. It operates until it finds a match, receives a mode change, or powers down. See S:2/4.</p> <p>Your programming device interrogates this value when providing "end step before file x, rung y" status line information. Your programming device also writes this value when prompting you for "set end rung." There is no known use for this feature when addressed by your ladder program.</p>		•	•	•	•
		<p>This feature is built into the SLC 5/03 and higher processors. Selection is not required.</p>			•	•	•



**Table B.4 Status File Functions (Continued)**

Address	Classification	Description	Fixed 5/01	5/02	5/03	5/04	5/05
S:20 and S:21	Status	<p><b>Test - Fault/Powerdown - Rung/File</b></p> <p>These registers indicate the executable rung (word S:20) and file (word S:21) number that the processor last executed before a major error or powerdown occurred. To enable this feature, you must select the Test Single Step option at the time you save your program. You can use these registers to pinpoint the execution point of the processor at the last powerdown or fault routine entry. This function is also active in the REM Run mode. See S:2/4.</p> <p><b>Application example:</b> Suppose your program contains several TON instructions. TON T4:6 in file 2, rung 25 occasionally obtains a negative preset. Recovery from the negative preset fault is possible by placing the preset at 100 and resetting the timer.</p> <p>Place the following rung in your fault routine to accomplish this. Bit B3/0 is latched as evidence that an application recovery has been initiated.</p>		•	•	•	•
		<p>This feature is built into the SLC 5/03 and higher processors. Selection is not required.</p>			•	•	•

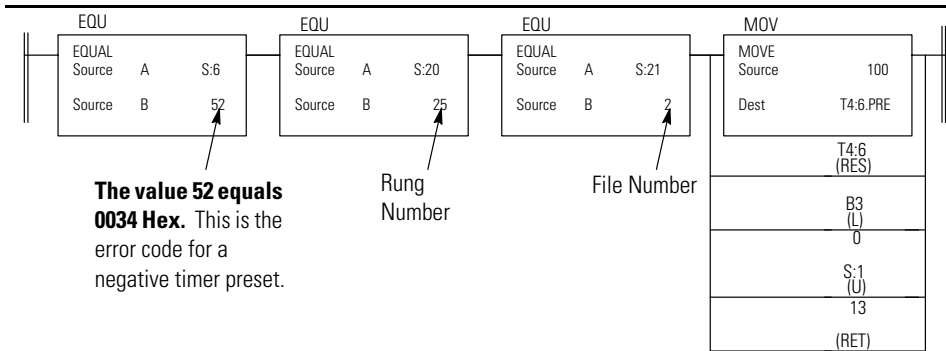

**Table B.4 Status File Functions (Continued)**

Address	Classification	Description	Fixed 5/01	5/02	5/03	5/04	5/05
S:22	Status	<p><b>Maximum Observed Scan Time</b></p> <p>This word indicates the maximum observed interval between consecutive scans.</p> <p>Consecutive scans are defined as intervals between file 2/rung 0 and the END, TND, or the REF instruction. This value indicates, in 10 ms increments, the time elapsed in the longest program cycle of the processor. The processor compares each last scan value to the value contained in S:22. If the processor determines that the last scan value is larger than the value stored at S:22, the last scan value is written to S:22.</p> <p>Resolution of the maximum observed scan time value is +0 to -10 ms. For example, the value 9 indicates that 80 to 90 ms was observed as the longest program cycle.</p> <p>Interrogate this value using the Data Monitor function if you need to determine or verify the longest scan time of your program.</p>		•	•	•	•
		<p>The Scan Time Selection Bit (S:33/13) determines the timebase used for average and maximum Scan Times. When clear, operation is as described above. When set, the timebase is expressed in 1 ms increments (instead of 10 ms increments). When S:33/13 is set, resolution of the maximum observed scan time value is +0 to -10 ms. For example, the value 9 indicates that 8 to 9 ms was observed as the largest program cycle.</p>			•	•	•
S:23	Status	<p><b>Average Scan Time</b></p> <p>This word indicates a weighted running average time. The value indicates, in 10 ms increments, the time elapsed in the average program cycle of the processor. For every Scan t:</p> $\text{Avg} = \frac{(\text{Avg} * 7) + \text{Scan}_t}{8}$ <p>Resolution of the average scan time value is +0 to -10 ms. For example, the value 2 indicates that 10 to 20 ms was calculated as the average program cycle.</p>		•	•	•	•
		<p>The Scan Time Selection bit S:33/13 determines the timebase used for average Scan time. When clear, operation is as described above. When set, the timebase is expressed in 1 ms increments (instead of 10 ms increments). When S:33/13 is set, resolution of the average scan time value is +0 to -10 ms. For example: the value 2 indicates that 1 to 2 ms was calculated as the average program cycle.</p>			•	•	•

**Table B.4 Status File Functions (Continued)**

Address	Classification	Description	Fixed 5/01	5/02	5/03	5/04	5/05
S:24	Dynamic Config	<b>Index Register</b>  This word indicates the element offset used in indexed addressing.  When an STI, I/O Slot, or Fault Routine interrupts normal execution of your program, the original value of this register is restored when execution resumes.		•	•	•	•
		When a DII interrupts normal execution of your program, the original value of this register is restored when execution resumes.			•	•	•
S:25 and S:26	Status	<b>I/O Interrupt Pending</b>  These two words are bit-mapped to the 30 I/O slots. Bits S:25/1 through S:26/14 refer to slots 1 through 30. Bits S:25/0 and S:26/15 are reserved.  The pending bit associated with an interrupting slot is set when the corresponding I/O Slot Interrupt Enable bit is clear at the time of an interrupt request. It is cleared when the corresponding I/O Event Interrupt Enable bit is set, or when an associated RPI instruction is executed.  The pending bit for an executing I/O interrupt subroutine remains clear when the ISR is interrupted by an STI or fault routine. Likewise, the pending bit remains clear if interrupt service is requested at the time that a higher or equal priority interrupt is executing (fault routine, STI, or other ISR).		•	•	•	•
		The pending bit associated with an interrupting slot is set when the corresponding I/O Slot Interrupt Enable bit is clear at the time of an interrupt request. It is cleared when the corresponding I/O Event Interrupt Enable bit is set, or when an associated RPI instruction is executed. The pending bit is always set when interrupt service is requested and the processor is executing an interrupt of equal or higher priority. Interrupt priority does not affect the setting of these bits.  For example, while executing an STI subroutine, slot 6 requests an I/O Event Interrupt. The STI executes to completion; however, slot 6 pending bit (S:25/6) becomes set within execution of the STI. Examine the state of these bits within your interrupt subroutines if your application requires this information.			•	•	•

**Table B.4 Status File Functions (Continued)**

Address	Classification	Description	Fixed 5/01	5/02	5/03	5/04	5/05
S:27 and S:28	<b>Status</b>	<p><b>I/O Interrupt Enabled</b></p> <p>These two words are bit-mapped to the 30 I/O slots. Bits S:27/1 through S:28/14 refer to slots 1 through 30. Bits S:27/0 and S:28/15 are reserved.</p> <p>The default value of each bit is 1 (set). The enable bit associated with an interrupting slot must be set when the interrupt occurs to allow the corresponding ISR to execute. Otherwise, the ISR does not execute and the associated I/O slot interrupt pending bit becomes set.</p> <p>Changes made to these bits using the Data Monitor function or ladder instructions other than IID or IIE take affect at the next end of scan.</p>		•	•	•	•
	<b>Dynamic Config</b>	<p>These bits may be set/reset by the user program, comms., or with the IIE or IID instruction. Changes made to these bits using a programming terminal's Data Monitor function or any ladder instruction take effect immediately.</p>			•	•	•
S:29	<b>Dynamic Config</b>	<p><b>User Fault Routine File Number</b></p> <p>You enter a program file number (3 to 255) to be used in all recoverable and non-recoverable major errors. Program the ladder logic of your fault routine in the file you have specified. Write a zero value to disable the fault routine.</p> <p>To provide protection from inadvertent Data Monitor alteration of your selection, program an unconditional MOV instruction containing the program file number of your fault routine to S:29, or program a CLR instruction at S:29 to prevent fault routine operation.</p>		•	•	•	•

Table B.4 Status File Functions (Continued)

Address	Classification	Description	Fixed 5/01	5/02	5/03	5/04	5/05
S:30	Dynamic Config	<p><b>Selectable Timed Interrupt - Setpoint</b></p> <p>You enter the timebase, in tens of milliseconds, to be used in the selectable timed interrupt. Your STI routine executes per the value you enter. Write a zero value to disable the STI.</p> <p>To provide protection from inadvertent Data Monitor alteration of your selection, program an unconditional MOV instruction containing the setpoint value of your STI to S:30, or program a CLR instruction at S:30 to prevent STI operation.</p> <p>If the STI is initiated while in the REM Run mode by loading the status registers, the interrupt starts timing from the end of the program scan in which the status registers were loaded. If the STI has been previously configured (with a different setpoint), the new setpoint takes effect only after the previously-configured STI has timed out.</p> <p>Selectable timed interrupts are discussed on page 11-8 of this manual.</p>		•	•	•	•
		<p>The STI Setpoint timebase can be either 10 ms or 1 ms depending on the value of the STI Setpoint Selection bit S:2/10. When clear, operation is as described above. When set, the timebase is expressed in 1 ms increments. The STE enables and STD disables the STI instruction.</p>			•	•	•
S:31	Dynamic Config	<p><b>Selectable Timed Interrupt - File Number</b></p> <p>You enter a program file number (3 to 255) to be used as the selectable timed interrupt subroutine. Write a zero value to disable the STI.</p> <p>To provide protection from inadvertent Data Monitor alteration of your selection, program an unconditional MOV instruction containing the file number value of your STI to S:31, or program a CLR instruction at S:31 to prevent STI operation.</p> <p>Selectable timed interrupts are discussed on page 11-8 of this manual.</p>		•	•	•	•

**Table B.4 Status File Functions (Continued)**

Address	Classification	Description	Fixed 5/01	5/02	5/03	5/04	5/05
S:32	Status	<p><b>I/O Interrupt Executing</b></p> <p>This word indicates the slot number of the specialty I/O module that generated the currently executing ISR. This value is cleared upon completion of the ISR, REM Run mode entry, or upon power-up.</p> <p>You can interrogate this word inside of your STI subroutine or fault routine if you wish to know if these higher priority interrupts have interrupted an executing ISR. You may also use this value to discern interrupt slot identity when multiplexing two or more specialty I/O module interrupts to the same ISR.</p> <p>I/O interrupts are discussed on page 11-27 of this manual.</p>		•	•	•	•
		<p>You can interrogate this word inside your DII subroutine if you wish to know if these higher priority interrupts have interrupted an executing ISR. You may also use this value to discern interrupt slot identity when multiplexing two or more specialty I/O module interrupts to the same ISR.</p>			•	•	•
S:33/0	Status	<p><b>Incoming Command Pending (Channel 0)</b></p> <p>This bit becomes set when the processor determines that another node on the channel 0 network has requested information or supplied a command to it. This bit can be set at any time. This bit is cleared when the processor services the request (or command).</p> <p>Use this bit as a condition of an SVC instruction to enhance the communication capability of your processor.</p>			•	•	•
S:33/1	Status	<p><b>Message Reply Pending (Channel 0)</b></p> <p>This bit becomes set when another node on the channel 0 network has supplied the information that you requested in the MSG instruction of your processor. This bit is cleared when the processor stores the information and updates your MSG instruction.</p> <p>Use this bit as a condition of an SVC instruction to enhance the communication capability of your processor.</p>			•	•	•
S:33/2	Status	<p><b>Outgoing Message Command Pending (Channel 0)</b></p> <p>This bit is set when one or more channel 0 messages in your program are enabled and waiting, but no message is being transmitted at the time. As soon as transmission of a message begins, the bit is cleared. After transmission, the bit is set again if there are further messages waiting, or it remains cleared if there are no further messages waiting.</p>			•	•	•

Table B.4 Status File Functions (Continued)

Address	Classification	Description	Fixed 5/01	5/02	5/03	5/04	5/05
S:33/3	Status	<p><b>Selection Status (Channel 0)</b></p> <p>When set, this bit indicates that the channel 0 communication port is in the System mode (DF1 mode). When reset, this bit indicates that channel 0 is in the User mode (ASCII mode). Use your programming devices channel configuration utility to change this selection.</p>			•	•	•
S:33/4	Status	<p><b>Communications Active (Channel 0)</b></p> <p><i>DH-485 protocol only.</i> This bit is set by the processor when at least one other node is active on channel 0 DH-485 network. Otherwise the bit remains cleared.</p>			•	•	•
S:33/5	Dynamic Config	<p><b>Communications Servicing Selection (Channel 0)</b></p> <p>When set, only one channel 0 communication request/command will be serviced per END, TND, REF, or SVC instruction. When clear, all serviceable incoming or outgoing communication requests/commands will be serviced per END, TND, REF, or SVC instruction.</p> <p>One communication request/command consists of either a channel 0 Incoming Command, channel 0 Message Reply, or channel 0 Outgoing Message Command. Refer to Words S:33/0, S:33/1, S:33/2, and S:33/6 for more information.</p> <p><b>Note:</b> When clear, your communication throughput will increase. Your scan time will also increase if several communication commands/requests are received in the same scan.</p> <p>To program this feature, use the Data Monitor function to set and clear this bit. To provide protection from inadvertent data monitor alteration of your selection, program an unconditional OTL instruction at address S:33/5 to ensure one request/command operation, or an unconditional OTU instruction at address S:33/5 to ensure multiple request/command operation. Alternately, your program may change the state of this bit using ladder logic if your application requires dynamic selection of this function.</p>			•	•	•
S:33/6	Dynamic Config	<p><b>Message Servicing Selection (Channel 0)</b></p> <p>This bit is only valid when the channel 0 Comms Servicing Selection (S:33/5) is clear (which selects service all commands). When S:33/6 is clear and S:33/5 is clear, all outgoing channel 0 MSG instructions will be serviced per END, TND, SVC, or REF instruction. Otherwise, only one outgoing channel 0 MSG command or reply will be serviced per END, TND, SVC, or REF instruction.</p>			•	•	•

**Table B.4 Status File Functions (Continued)**

Address	Classification	Description	Fixed 5/01	5/02	5/03	5/04	5/05
<b>S:33/7</b>	<b>Dynamic Config</b>	<p><b>Message Servicing Selection (Channel 1)</b></p> <p>This bit is only valid when the channel 1 Comms Servicing Selection bit (S:2/15) is clear (which selects service all commands). When S:33/7 is clear and S:2/15 is clear, all outgoing channel 1 MSG instructions are serviced per END, TND, SVC, or REF instruction. Otherwise, only one outgoing channel 1 MSG command or reply is serviced per END, TND, SVC, or REF instruction.</p>			•	•	•
<b>S:33/8</b>	<b>Static Config</b>	<p><b>Interrupt Latency Control Bit</b></p> <p>When set, interrupt latency occurs for user interrupts (DII, STI, and I/O Event). This means that when an interrupt occurs, you are guaranteed to be at rung 0 of your interrupt subroutine within the stated interrupt latency period (assuming no interrupt of equal or higher priority is executing). You must select this at the time you save your program.</p> <p>When clear, user interrupts may only interrupt the processor at predefined points of execution in the user program cycle. Interrupt latency is then defined as the longest period of time that can occur between any two predefined points. When S:33/8 is clear, you must analyze each user program. The bit is clear by default.</p> <p>The following points are the only points in which user interrupt subroutines are allowed to execute when S:33/8 is clear:</p> <ul style="list-style-type: none"> <li>• at the start of each rung</li> <li>• following the servicing of communication</li> <li>• between slots when updating the input or output image, or any specialty I/O card</li> </ul>			•	•	•
<b>S:33/9</b>	<b>Status</b>	<p><b>Scan Toggle Bit</b></p> <p>This bit is cleared upon entry into the RUN mode. This bit changes state each and every execution of an END, TND, or REF instruction. Use this bit in your user program for applications such as multiplexing subroutine execution.</p>			•	•	•



**Table B.4 Status File Functions (Continued)**

Address	Classification	Description	Fixed 5/01	5/02	5/03	5/04	5/05															
S:33/10	Dynamic Config	<p><b>Discrete Input Interrupt Reconfiguration Bit</b></p> <p>Set this bit with your user program or programming terminal to cause the DII function to reconfigure itself at the next interrupt occurrence or end of each scan (END, TND, or REF). This bit is applied upon a DII ISR, fault routine, STI ISR, or Event ISR exit.</p> <p>The following occurs when the DII is reconfigured:</p> <ol style="list-style-type: none"> <li>1. The DII Accumulator is cleared (S:52).</li> <li>2. DII parameters located in words S:46 through S:50 are applied.</li> <li>3. The DII reconfigure bit is cleared by the processor.</li> </ol> <p>For example, use the following ladder structure to cause a DII reconfiguration from your main ladder file each time input 0 is cycled on.</p> <pre style="text-align: center;">           I:1/0      B3/0      S:33/10           ] [----- [OSR]----- (L)-----         </pre> <p>Use the following ladder structure to cause a DII reconfiguration from an event based subroutine. The subroutine is only executed once, each time the DII reconfiguration is possible.</p> <pre style="text-align: center;">           I:1/0      S:33/10           ] [----- (L)-----         </pre>			•	•	•															
S:33/11 and S:33/12	Status	<p><b>Online Edit Status</b></p> <p>These two bits represent the four possible Online Edit states:</p> <table border="1" style="margin-left: auto; margin-right: auto;"> <thead> <tr> <th>Bit 12</th> <th>Bit 11</th> <th>Online Edit Status</th> </tr> </thead> <tbody> <tr> <td>0</td> <td>0</td> <td>No online edits exist</td> </tr> <tr> <td>0</td> <td>1</td> <td>Online edits are disabled</td> </tr> <tr> <td>1</td> <td>1</td> <td>Testing online edits</td> </tr> <tr> <td>1</td> <td>0</td> <td>not used</td> </tr> </tbody> </table> <p>Examine the state of these bits with your user program to count the number of online edit sessions, flag an alarm, or place your application in a special state designed for online edit sessions.</p>	Bit 12	Bit 11	Online Edit Status	0	0	No online edits exist	0	1	Online edits are disabled	1	1	Testing online edits	1	0	not used			•	•	•
Bit 12	Bit 11	Online Edit Status																				
0	0	No online edits exist																				
0	1	Online edits are disabled																				
1	1	Testing online edits																				
1	0	not used																				

**Table B.4 Status File Functions (Continued)**

Address	Classification	Description	Fixed 5/01	5/02	5/03	5/04	5/05
S:33/13	Static Config	<p><b>Scan Time Timebase Selection</b></p> <p>This bit determines the timebase used to average the Scan time (S:23) and the maximum Scan Time (S:22). When clear, the value contained in the average and maximum scan times represent the number of 10 ms increments that have occurred. When set, the value contained in the average and maximum scan times represent the number of 1 ms increments that have occurred. This value is clear by default (10 ms timebase).</p>			•	•	•
S:33/14	Dynamic Config	<p><b>DTR Control Bit (Channel 0)</b></p> <p>This bit is used to enable DTR dialing. When clear, the channel 0 DTR signal (pin 4) is directly controlled by the standard communication driver. When set, you can perform DTR dialing by writing to S:33/15, DTR Force Bit.</p> <p>Bit S:33/14 is examined and applied at each end of scan (END, TND, or REF). When in Program, Suspend, or Fault mode, DTR is enabled and remains enabled until an auto-disconnect sequence is detected by the communication driver.</p> <p>An auto-disconnect occurs if the communication driver detects that channel 0 CD signal (pin 1) has been absent for more than 10 seconds or if the channel 0 DSR signal (pin 6) has been disabled. Refer to S:5/14 Channel 0 Modem Lost bit for more information. During an auto-disconnect, the standard communication driver keeps the DTR disabled until either the channel 0 DSR signal is enabled, or 5 seconds elapse.</p> <p><b>Note:</b> When channel 0 is configured for DH-485, S:33/14 must be clear for proper operation.</p>			•	•	•
S:33/15	Dynamic Config	<p><b>DTR Force Bit (Channel 0)</b></p> <p>This bit is used to force the DTR pin high or low. When S:33/14 is set, the channel 0 DTR signal (pin 4) is applied at each end of scan (END, TND, or REF) using the state of S:33/15. When S:33/14 is clear, this bit has no effect on DTR.</p> <p>When S:33/15 is set, DTR is forced high. When clear (default), DTR is forced low. When in the REM Test or REM Run mode, this bit is only applied at end of scan (END, TND, or REF). When in Program, Suspend, or Fault mode (or on power up), DTR is set unless the communication driver is performing an auto-disconnect.</p>			•	•	•

**Table B.4 Status File Functions (Continued)**

Address	Classification	Description	Fixed 5/01	5/02	5/03	5/04	5/05
S:34/0	Dynamic Config	<p><b>DH-485 Passthru Disabled Bit</b></p> <p>When channel 0 is configured for DH-485 protocol, this bit provides the capability to pass received packets between channels. When set, the processor does not support passthru. When reset, the processor allows packets to be passed from one channel to the other. Only packets that contain the Internet network layer remote MSG packets and whose Destination Link ID equals that specified for the opposite channel will be passed. The default is reset.</p> <p>The default Link ID for channel 0 is one. The default Link ID for channel 1 is two.</p>			•	•	•
S:34/1	Static Config	<p><b>DH+ Active Node Table Enable Bit</b></p> <p>This bit enables processing of the DH+ active node table. When set, the DH+ active node table is processed. When clear, the DH+ active node table is not processed. The default is clear.</p> <p>This bit is evaluated upon each entry into the REM Run mode. Note that the processor updates individual status words S:83 to S:86.</p>				•	
S:34/2	Dynamic Config	<p><b>Floating Point Math Flag Disable Bit</b></p> <p>This bit disables the processing of math flags when using floating point math (F8:). The math flags effected are Overflow (S:0/1), Zero (S:0/2), Sign (S:0/3), and the Minor Error Overflow Trap bit (S:5/0). When the bit is clear, the math flags are processed. When the bit is set, the math flags are cleared except for the Minor Error Overflow Trap bit which remains in its last state. The Carry Flag (S:0/0) is reserved for internal use during all floating point operations. The default is clear.</p> <p>Instructions effected by floating point include ADD, SUB, MUL, DIV, NEG, SQR, and MOV. Setting this bit reduces the execution times for the above instructions. This bit is evaluated when each instruction is executed.</p>				•	•
S:34/3	Dynamic Config	<p><b>Global Status Word Transmit Enable Bit</b></p> <p>When this bit is set, the Global Status Word at S:99 is transmitted with every DH+ token pass. When clear, the token is passed without the Global Status Word.</p>				•	
S:34/4	Dynamic Config	<p><b>Global Status Word Receive Enable Bit</b></p> <p>When this bit is set, the processor collects the Global Status Word being transmitted by other devices on the DH+ network and stores them in the Global Status File (S:100-S:163). When clear, the processor ignores the Global Status information from other devices on the network.</p>				•	

**Table B.4 Status File Functions (Continued)**

Address	Classification	Description	Fixed 5/01	5/02	5/03	5/04	5/05
S:34/5	Dynamic Config	<p><b>DF1 Passthru Enabled Bit</b></p> <p>If channel 0 is enabled with a DF1 protocol and this bit is SET, then the passthru operation is enabled between Channel 0 and Channel 1. Passthru supported DF1 protocols include DF1 Full-duplex, DF1 Half-duplex, and DF1 Radio Modem. Refer to Chapter 14 for additional passthru information.</p>			•	•	•
S:34/6	Dynamic Config	<p><b>DF1 Remote/Local Passthru bit</b></p> <p>When set, SLC 5/03 DF1 passthru command packets are transmitted on the channel 1 DH-485 network as local command packets. This is important to set when trying to access nodes on a DH-485 network that do not support remote packets. When reset, the SLC 5/03 DF1 passthru command packets are transmitted on the DH-485 network as remote command packets. The default is reset.</p>			•		
S:34/7	Status	<p><b>Local Passthru Queue Full bit</b></p> <p>This bit is set by the SLC 5/03 processor when there are no available entries in the passthru queue. Entries may be lost if active nodes on the Channel 1 DH-485 network fail to respond. Use this bit in conjunction with the ACL instructions to flush the passthru queue. Refer to chapter 10 for more information regarding the ACL instruction.</p>			•		
S:34/8	Status	<p><b>Processor Secured Bit</b></p> <p>This bit indicates that the processor has been secured through RSLogix 500 version 7.10 or higher. Once you have been authenticated and authorized via RSAssetSecurity, you will be able to go online and upload and download this processor using RSLogix 500 version 7.10 or higher. If the processor is secured, the only way to unsecure it is to either disconnect the battery and clear processor memory back to factory default, or install a memory module with an unsecured program configured to autoload at powerup.</p>			•	•	•
S:35	Status	<p><b>Last 1 ms Scan Time</b></p> <p>The value of this word tells you how much time elapsed in a program cycle. A program cycle includes the ladder program, housekeeping, I/O scan, and servicing of the communication port. This word value is only updated by the processor once each scan, immediately preceding the execution of rung 0, file 2 (or upon return of a REF instruction).</p>			•	•	•
S:36/0 to S:36/7	NA	<b>Reserved</b>			•	•	•

**Table B.4 Status File Functions (Continued)**

Address	Classification	Description	Fixed 5/01	5/02	5/03	5/04	5/05
<b>S:36/8</b>	<b>Status</b>	<b>DII Lost</b>  This bit is set anytime a DII interrupt occurs while the DII Pending bit (S:2/11) is also set. When set, you are notified that a DII interrupt has been lost. For example, the interrupt is lost because a previous interrupt was already pending and waiting execution. Examine this bit in your user program and take appropriate action if your application cannot tolerate this condition. Then clear this bit with your user program to prepare for the next possible occurrence of this error.			•	•	•
<b>S:36/9</b>	<b>Status</b>	<b>STI Lost</b>  This bit is set anytime an STI interrupt occurs while the STI Pending bit (S:2/0) is also set. When set, you are notified that a STI interrupt has been lost. For example, the interrupt is lost because a previous interrupt was already pending and waiting execution. Examine this bit in your user program and take appropriate action if your application cannot tolerate this condition. Then clear this bit with your user program to prepare for the next possible occurrence of this error.			•	•	•
<b>S:36/10</b>	<b>Status</b>	<b>Memory Module Data File Overwrite Protection</b>  Use this bit to determine the validity of retentive data following a memory module transfer. This bit is always set when a memory module to processor transfer occurs with Data File Overwrite Protection selected and protected files are overwritten. Protected files are overwritten anytime a memory module program does not match the processor program at the time of the transfer. This bit is not cleared by the processor.			•	•	•
<b>S:36/11 to S:36/15</b>	<b>NA</b>	<b>Reserved for additional minor errors.</b>			•	•	•
<b>S:37</b>	<b>Dynamic Config</b>	<b>Clock/Calendar Year</b>  This value contains the year value of the clock/calendar. Valid range is 0 to 65535. To disable the clock/calendar, write zeros to all clock/calendar words (S:37 to S:42).			•	•	•
<b>S:38</b>	<b>Dynamic Config</b>	<b>Clock/Calendar Month</b>  This value contains the month value of the clock/ calendar. Valid range is 1 to 12. To disable the clock/calendar, write zeros to all clock or calendar words (S:37 to S:42). January equals the value of 1.			•	•	•

**Table B.4 Status File Functions (Continued)**

Address	Classification	Description	Fixed 5/01	5/02	5/03	5/04	5/05
S:39	Dynamic Config	<p><b>Clock/Calendar Day</b></p> <p>This value contains the day value of the clock/calendar. Valid range is 1 to 31. To disable the clock/calendar, write zeros to all clock or calendar words (S:37 to S:42). The first day of the month equals the value of 1. See status word S:53 for Day-of-Week.</p>			•	•	•
S:40	Dynamic Config	<p><b>Clock/Calendar Hours</b></p> <p>This value contains the hour value of the clock/calendar. Valid range is 0 to 23. To disable the clock/calendar, write zeros to all clock or calendar words (S:37 to S:42). 0000 hundred hours equals the value of 0.</p>			•	•	•
S:41	Dynamic Config	<p><b>Clock/Calendar Minutes</b></p> <p>This value contains the minute value of the clock/calendar. Valid range is 0 to 59. To disable the clock/calendar, write zeros to all clock or calendar words (S:37 to S:42).</p>			•	•	•
S:42	Dynamic Config	<p><b>Clock/Calendar Seconds</b></p> <p>This value contains the seconds value of the clock/calendar. Valid range is 0 to 59. To disable the clock/calendar, write zeros to all clock or calendar words (S:37 to S:42).</p>			•	•	•
	<p><b>ATTENTION</b></p> 	<p>The second value may not reliably increment every second, and therefore should not be relied upon for seconds-based control or selection. Use the STI function for reliable time-based control or calculations.</p>					
S:43	Status	<b>Selectable Timed Interrupt - 10 µs Timer</b>			•	•	•
S:44		<b>I/O Event Interrupt - 10 µs Timer</b>					
S:45		<b>Discrete Input Interrupt - 10 µs Timer</b>					
		<p>This 16-bit value is “free running” and is used to measure the amount of time that expires between consecutive interrupt subroutine executions (in increments of 10 µs). This value is updated upon each entry into the interrupt subroutine. The 10 µs timer dictates that the maximum amount of time that can expire between any two interrupts and still result in a valid time measurement is 0.32767 seconds. (16-bit signed x 10 µs = 32767 x .00001 = 0.32767 seconds)</p> <p>The 10 µs timer is common to the STI interrupt, the Event I/O interrupt, and the DII interrupt.</p>					

**Table B.4 Status File Functions (Continued)**

Address	Classification	Description	Fixed 5/01	5/02	5/03	5/04	5/05
<b>S:46</b>	<b>Dynamic Config</b>	<p><b>Discrete Input Interrupt - File Number</b></p> <p>You enter a program file number (3-255) to be used as the discrete input interrupt subroutine. Write a zero value to disable the function. This value is applied upon detection of a DII Reconfigure bit, each DII ISR exit, and each end of scan (END, TND, or REF).</p> <p>To provide protection from inadvertent data monitor alteration of your selection, program an unconditional MOV instruction containing the file number value of your DII to S:46 or program a CLR instruction at S:46 to prevent DII operation.</p>			•	•	•
<b>S:47</b>	<b>Dynamic Config</b>	<p><b>Discrete Input Interrupt - Slot Number</b></p> <p>You enter the slot number (1-30) that contains the Discrete I/O module to be used as the discrete input interrupt slot. The processor will fault if the slot is empty or contains a non-discrete I/O module. For example, an analog module causes a processor fault to occur. This bit is applied upon detection of the DII Reconfigure bit.</p> <p>This value is only applied upon execution of the DII reconfiguration function (setting bit S:33/10 or upon REM Run mode entry with the DII Enable bit S:2/12 set).</p> <p>To provide protection from inadvertent data monitor alteration of your selection, program an unconditional MOV instruction containing the slot number value of your DII to S:47.</p>			•	•	•
<b>S:48</b>	<b>Dynamic Config</b>	<p><b>Discrete Input Interrupt - Bit Mask</b></p> <p>You enter a bit mapped value that corresponds to the bits that you wish to monitor on the discrete I/O module. Only bits 0 to 7 are used in the DII function. Setting a bit indicates that you wish to include the bit in the comparison of the discrete I/O module's bit transition to the DII Compare Value (S:49). Clearing a bit indicates that the transition state of that particular bit is a "don't care" bit. This value is applied upon detection of a DII Reconfigure bit, each DII ISR exit, and at each end of scan (END, TND, or REF).</p> <p>To provide protection from inadvertent data monitor alteration of your selection, program an unconditional MOV instruction containing the bit mask value of your DII to S:48.</p>			•	•	•

**Table B.4 Status File Functions (Continued)**

Address	Classification	Description	Fixed 5/01	5/02	5/03	5/04	5/05
S:49	Dynamic Config	<p><b>Discrete Input Interrupt - Compare Value</b></p> <p>You enter a bit mapped value that corresponds to the bit transitions that must occur in the discrete I/O card for a count or interrupt to occur. Only bits 0 to 7 are used in the DII function. Setting a bit indicates that the bit must transition from a 0 to a 1 to satisfy the compare condition for that bit. Clearing a bit indicates that the bit must transition from a 1 to a 0 in order to satisfy the compare condition for that bit. An interrupt or count will be generated upon the last bit transition of the compare value. This value is applied upon detection of a DII Reconfigure bit, each DII ISR exit, and each end of scan (END, TND, or REF).</p> <p>To provide protection from inadvertent data monitor alteration of your selection, program an unconditional MOV instruction containing the compare value of your DII to S:49.</p>			•	•	•
S:50	Dynamic Config	<p><b>Discrete Input Interrupt - Preset</b></p> <p>When this value is equal to 0 or 1, an interrupt is generated each time the comparison specified in words S:48 and S:49 is satisfied. When this value is between 2 and 32767, a count will occur each time the bit comparison is satisfied. An interrupt will be generated when the accumulator value reaches 1 or exceeds the preset value. This value is applied on detection of DII Reconfigure bit, each DII ISR exit, and at each end of scan (END, TND, or REF).</p> <p>To provide protection from inadvertent data monitor alteration of your selection, program an unconditional MOV instruction containing the preset value of your DII to S:50.</p>			•	•	•
S:51	Status	<p><b>Discrete Input Interrupt - Return Mask</b></p> <p>The return mask is updated immediately preceding entry into the DII subroutine. This value contains the bit map of the bit transitions that caused the interrupt. The bit is set if it was included in the list of bit transitions that caused the interrupt, (specified to transition in the S:48 and S:49 comparisons). The bit is cleared if it was masked. This value is cleared by the processor upon exit of the DII subroutine.</p> <p>Use this value to validate the interrupt transitions. Or when dynamically reconfiguring (sequencing) the DII, you can use this value inside your DII's subroutine to help determine or validate its position in the sequence.</p>			•	•	•
S:52	Status	<p><b>Discrete Input Interrupt - Accumulator</b></p> <p>The DII accumulator contains the number of counts that have occurred (see S:50.) When a count occurs, and the accumulator is greater than or equal to the preset value, a DII interrupt is generated.</p>			•	•	•



**Table B.4 Status File Functions (Continued)**

Address	Classification	Description	Fixed 5/01	5/02	5/03	5/04	5/05
<b>S:53L</b>	<b>Dynamic Config</b>	<b>Day-of-Week</b>  This value contains the day-of-week value of the clock/calendar. Valid range is 0 to 6 (Sunday=0). To disable the clock/calendar, write zeros to all clock and calendar words (S:37 to S:42).			•	•	•
<b>S:53H</b>	<b>NA</b>	<b>Reserved</b>			•	•	•
<b>S:54</b>	<b>Status</b>	<b>Last Major Error Fault Code</b>  Mirrors the last error code value stored in S:6.			•	•	•
<b>S:55</b>	<b>Status</b>	<b>Last Discrete Input Interrupt Scan Time</b>  This value indicates, in 1 ms increments, the amount of time elapsed by the most recent DII subroutine. The resolution of this value is +0 to -1 ms.			•	•	•
<b>S:56</b>	<b>Status</b>	<b>Maximum Observed Discrete Input Scan Time</b>  This value indicates, in 1 ms increments, the maximum amount of time elapsed by any single DII subroutine execution. The processor compares each last DII scan value (S:55) to the maximum DII scan value contained in S:56. If the processor determines that the last DII scan value is larger than the value stored at S:56, the last scan value (S:55) is written to S:56, thus becoming the new maximum DII scan time. The resolution of this value is +0 to -1 ms.  Interrogate this value using a programming device Data Monitor function if you need to determine or verify the longest scan time of your program.			•	•	•
<b>S:57</b>	<b>Status</b>	<b>Operating System Catalog Number</b>  Indicates the operating system catalog number. For example, the value of 300 indicates operating system -OS300, the value of 301 indicates -OS301.			•	•	•
<b>S:58</b>	<b>Status</b>	<b>Operating System Series</b>  Indicates the operating system series. For example, the value of 0 indicates series A and the value of 1 indicates series B.			•	•	•
<b>S:59</b>	<b>Status</b>	<b>Operating System FRN</b>  Indicates the operating system firmware release number. For example, the value of 1 indicates FRN1 and the value of 2 indicates FRN2.			•	•	•
<b>S:60</b>	<b>Status</b>	<b>Processor Catalog Number</b>  Indicates the catalog number of the processor. For example, the value of 532 indicates -L532 and the value of 534 indicates -L534.			•	•	•

**Table B.4 Status File Functions (Continued)**

Address	Classification	Description	Fixed 5/01	5/02	5/03	5/04	5/05
S:61	Status	<p><b>Processor Series</b></p> <p>Indicates the processor series. For example, the value of 0 indicates series A and the value of 1 indicates series B.</p>					
S:62	Status	<p><b>Processor Revision</b></p> <p>Indicates the processor revision. For example, the value of 1 indicates REV1 and the value of 2 indicates REV2.</p>			•	•	•
S:63	Status	<p><b>User Program Type</b></p> <p>Indicates the programming device that created the user program.</p>			•	•	•
S:64	Status	<p><b>User Program Functionality Index</b></p> <p>Indicates the level of functionality contained in a given program type.</p>			•	•	•
S:65	Status	<p><b>User RAM Size</b></p> <p>Applies to SLC 5/03 (OS302), SLC 5/04 (OS401), and SLC 5/05 processors.</p> <p>Indicates the size of NVRAM in instruction words. For example, the value 64 equals 64K instruction words of NVRAM.</p>			•	•	•
S:66	Status	<p><b>Flash EEPROM Size</b></p> <p>Indicates the size of operating system memory in 16 bit K words. For example, the value of 128 equals 128K words of memory.</p>			•	•	•
S:67 to S:82	Status	<p><b>Channel 0 Active Node Table</b></p> <p>When channel 0 is configured for DF1 Half-duplex Master or DH-485, these 16 words are bit mapped to represent status of the nodes on the network. For the DH-485 network only 32 possible nodes are allowed. For the DF1 Half-duplex Master network 255 nodes are allowed. Bit S:67/0 represents node 0, bit S:82/14 represents node 254, and bit S:82/15 is not used since address 255 is reserved for broadcasts.</p> <p>DF1 Half-duplex Master configured for either of the two standard polling modes has these bits set by the processor when a node is polled and it responds to the master poll. A node's bit is cleared if no response is received after a master poll.</p> <p>In DH-485 configuration, these bits are set by the processor when a node exists on the DH-485 link that your processor is connected to. These bits are cleared when a node is not present on the link.</p>			•	•	•

Table B.4 Status File Functions (Continued)

Address	Classification	Description	Fixed 5/01	5/02	5/03	5/04	5/05
S:67 to S:82	Dynamic Config	<p><b>DF1 Radio Modem Store and Forward Table</b></p> <p>In DF1 Radio Modem with Store and Forward enabled in the channel configuration, these 16 words are bit mapped to represent the 255 possible nodes and the broadcast address. The user is required to set these bits to enable Store and Forward operation. For a node on the radio modem network to rebroadcast a message, both the message's destination and source addresses must have their respective bits set in this table. To rebroadcast a broadcast message (destination = 255) only bit S:82/15 needs to be set.</p>			•	•	•
S:83 to S:86	Status	<p><b>Channel 1 Active Node Table</b></p> <p>These 4 words are bit mapped to represent the 64 possible nodes on a DH+ link. S:83/0 through S:86/15 represent node addresses 0 to 63 (0 to 77 octal). These bits are set by the processor when a node exists on the DH+ link that your processor is connected to. These bits are cleared when a node is not present on the link.</p> <p>Note that S:34/1 must be set for the above words to work.</p>				•	
S:87 to S:98	NA	<b>Reserved</b>				•	
S:99	Dynamic Config	<p><b>Global Status Word</b></p> <p>Data placed in this memory location is transmitted as the processor's Global Status Word and is sent to all other devices on the DH+ network every time the processor passes the DH+ token.</p>				•	
S:100 to S:163	Static Config	<p><b>Global Status File</b></p> <p>When a processor passes the DH+ token to the next node, it also sends a 16-bit word called the Global Status Word (S:99 and above). All of the nodes on the network read the Global Status Word sent by each processor and saves the word to memory. Each processor has a table (Global Status File) in memory where global status words from other processors are stored. This table is completely updated every token rotation. (Example: The word from node "x" is placed at S:100 + x.)</p> <p>You can use the Global Status File as a high-speed broadcast message for status passing and synchronization of processors.</p>				•	

The following table lists all combination settings for S:1/10, S:1/11 and S:1/12.

**Table B.5 Combination Settings for S:1/10, S:1/11, and S:1/12**

S:1/10	S:1/11	S:1/12	Memory Module Present?	SLC Memory Error?	Memory Module Transfer?	Mode Before/After Powerdown	Major Fault Before/After Powerdown
0	0	0	don't care	N/A	no	don't care/same	don't care/same
1	0	0	no	N/A	no	(REM) PROG/(REM) PROG	don't care/same
						REM RUN/faulted REM PROG	
						RUN/faulted RUN	
			yes	no	no	don't care/same	don't care/same
			yes	yes	yes	faulted PROG/PROG	
						faulted REM PROG/REM RUN	
			faulted RUN/RUN	faulted/no fault			
0	1	0	no	N/A	no	(REM) PROG/(REM) PROG	don't care/same
						REM RUN/faulted REM PROG	
						RUN/faulted RUN	
			yes	N/A	yes	don't care/same	don't care/no fault
0	0	1	no	N/A	no	(REM) PROG/(REM) PROG	don't care/same
						(REM) RUN/(REM) RUN	
			yes	N/A	yes	PROG/PROG	don't care/no fault
						REM PROG/REM RUN	
						(REM) RUN/(REM) RUN	
0	1	1	no	N/A	no	(REM) PROG/(REM) PROG	don't care/same
						REM RUN/faulted REM PROG	
						RUN/faulted RUN	
			yes	N/A	yes	PROG/PROG	don't care/no fault
						REM PROG/REM RUN	
						(REM) RUN/(REM) RUN	

## Memory Usage

This appendix provides:

- instruction words for the Fixed, SLC 5/01, SLC 5/02, SLC 5/03, SLC 5/04, and SLC 5/05 processor.
- examples on how to estimate the total memory usage of your system.

If you want to use a	See page
Fixed or SLC 5/01 processor	C-2
SLC 5/02 processor	C-7
SLC 5/03 processor	C-13
SLC 5/04 or SLC 5/05 processor	C-13

## Memory Usage Overview

SLC 500 controllers have the following user memory capacities.

**Table C.1 Processor Memory Capacity**

Type of Processor	User Memory Capacity
Fixed and SLC 5/01	1,024 instruction words
SLC 5/02	4,096 instruction words
SLC 5/03 8k	4,096 words
SLC 5/03, SLC 5/04, SLC 5/05 16k	12,288 words <sup>(1)</sup>
SLC 5/04, SLC 5/05 32k	28,672 words <sup>(1)</sup>
SLC 5/04, SLC 5/05 64k	61,440 words <sup>(1)</sup>

<sup>(1)</sup> When your ladder program is larger than 12k words, you must split your program into two files. A main (file 2) and at least one subroutine for(3 to 255) is required.

The following definitions apply when figuring your memory usage.

- fixed, SLC 5/01, and SLC 5/02: 1 instruction word = 4 data words = 8 bytes
- SLC 5/03, SLC 5/04, and SLC 5/05: 1 instruction word = 1 data word

## Fixed and SLC 5/01 Processors

The number of words used by an instruction is indicated in the following table. Since the program is compiled by the programmer, it is only possible to establish *estimates* for the instruction words used by individual instructions. The calculated memory usage will normally be greater than the actual memory usage, due to compiler optimization.

**Table C.2 SLC 500 Fixed and SLC 5/01 List of Instructions**

Mnemonic	Memory Usage (user words)	Name	Instruction Type	Page
ADD	1.5	Add	Math	4-5
AND	1.5	And	Data Handling	5-20
BSL	2.00	Bit Shift Left	Application Specific	7-4
BSR	2.00	Bit Shift Right	Application Specific	7-4
CLR	1.00	Clear	Math	4-12
COP	1.50	File Copy	Data Handling	5-13
CTD	1.00	Count Down	Basic	2-14
CTU	1.00	Count Up	Basic	2-13
DCD	1.50	Decode 4 to 1 of 16	Data Handling	5-10
DDV	1.00	Double Divide	Math	4-11
DIV	1.50	Divide	Math	4-9
EQU	1.50	Equal	Comparison	3-2
FLL	1.50	Fill File	Data Handling	5-13
FRD	1.00	Convert from BCD	Data Handling	5-5
GEQ	1.50	Greater Than or Equal	Comparison	3-4
GRT	1.50	Greater Than	Comparison	3-3
HSC	1.00	High-speed Counter	High-speed Counter	2-15
IIM	1.50	Immediate Input with Mask	Program Flow Control	6-8
IOM	1.50	Immediate Output with Mask	Program Flow Control	6-9
JMP	1.00	Jump to Label	Program Flow Control	6-2
JSR	1.00	Jump to Subroutine	Program Flow Control	6-3
LBL	0.50	Label	Program Flow Control	6-2
LEQ	1.50	Less Than or Equal	Comparison	3-3
LES	1.50	Less Than	Comparison	3-3
MCR	0.50	Master Control Reset	Program Flow Control	6-6
MEQ	1.50	Masked Compare for Equal	Comparison	3-4
MOV	1.50	Move	Data Handling	5-17
MUL	1.50	Multiply	Math	4-8
MVM	1.50	Masked Move	Data Handling	5-18

**Table C.2 SLC 500 Fixed and SLC 5/01 List of Instructions (Continued)**

<b>Mnemonic</b>	<b>Memory Usage (user words)</b>	<b>Name</b>	<b>Instruction Type</b>	<b>Page</b>
NEG	1.50	Negate	Data Handling	5-24
NEQ	1.50	Not Equal	Comparison	3-2
NOT	1.00	Not	Data Handling	5-23
OR	1.50	Or	Data Handling	5-21
OSR	1.00	One-shot Rising	Basic	2-5
OTE	0.75	Output Energize	Basic	2-4
OTL	0.75	Output Latch	Basic	2-4
OTU	0.75	Output Unlatch	Basic	2-4
RES	1.00	Reset	Basic	2-20
RET	0.50	Return from Subroutine	Program Flow Control	6-3
RTO	1.00	Retentive Timer	Basic	2-11
SBR	0.50	Subroutine	Program Flow Control	6-3
SQC	2.00	Sequencer Compare	Application Specific	7-6
SQO	2.00	Sequencer Output	Application Specific	7-6
SUB	1.50	Subtract	Math	4-5
SUS	1.50	Suspend	Program Flow Control	6-8
TND	0.50	Temporary End	Program Flow Control	6-7
TOD	1.00	Convert to BCD	Data Handling	5-2
TOF	1.00	Timer Off-delay	Basic	2-10
TON	1.00	Timer On-delay	Basic	2-9
XIC	1.00	Examine If Closed	Basic	2-3
XIO	1.00	Examine If Open	Basic	2-3
XOR	1.50	Exclusive Or	Data Handling	5-22

## Estimating Total Memory Usage of Your System Using a Fixed or SLC 5/01 Processor

\_\_\_\_\_

\_\_\_\_\_

\_\_\_\_\_

\_\_\_\_\_

\_\_\_\_\_

\_\_\_\_\_

\_\_\_\_\_

\_\_\_\_\_

1. Calculate the total instruction words used by the instructions in your program and enter the result. Refer to the table on page C-2.
2. Multiply the total number of rungs by 0.375 and enter the result.
3. Multiply the total number of data words (excluding the status field and I/O data words) by 0.25 and enter the result.
4. Add 1 word for each data table file and enter the result
5. Multiply the highest numbered program file used by 2 and enter the result.
6. Multiply the total number of I/O data words by 0.75 and enter the result.
7. Multiply the total number of I/O slots, used or unused, by 0.75 and enter the result.
8. To account for processor overhead, enter 65 if you are using a fixed controller, enter 67 if you are using a 1747-L511 or 1747-L514.
9. Total steps 1 through 8. This is the estimated total memory usage of your application system. Remember, this is an estimate, actual compiled programs may differ by  $\pm 12\%$ .
10. If you wish to determine the estimated amount of memory remaining in the processor you have selected, do the following:

If you are using a fixed controller or 1747-L511, subtract the total from 1024. If you are using a 1747-L514, subtract the total from 4096.

The result of this calculation will be the estimated total memory remaining in your selected processor.

**Total:** \_\_\_\_\_

**TIP**

The calculated memory usage may vary from the actual compiled program by  $\pm 12\%$ .



## Fixed Controller Memory Usage Example

---

### L20B Fixed I/O Controller

42	XIC and XIO	42 x 1.00	=	42.00
10	OPE instructions	10 x 0.75	=	7.50
10	TON instructions	10 x 1.00	=	10.00
1	CTU instruction	1 x 1.00	=	1.00
1	RES instruction	1 x 1.00	=	1.00
				<hr/>
Instruction Usage				61.50

21	rungs	21 x 0.375	=	7.87
37	data words	37 x 0.250	=	9.25

**User Program Total** **78.62**

2	I/O data words	2 x 0.75	=	1.50
1	slot	1 x 0.75	=	0.75
Overhead				65.00

**I/O Configuration Total** **67.25**

Estimated total memory usage: 145.87

**(round to 146)**

1024 - 146 = 878 instruction words remaining in the processor

## SLC 5/01 Processor Memory Usage Example

---

### 1747-L514 processor, 30-slot configuration, (15) 1746-IA16, (10) 1746-OA8, (1) 1747-DCM full configuration, (1) 1746-NI4, (1) 1746-NIO4I

50	XIC and XIO	50 x 1.00	= 50.00
15	OTE instructions	15 x 0.75	= 11.25
5	TON instructions	5 x 1.00	= 5.00
3	GRT instructions	3 x 1.50	= 4.50
1	SCL instruction	1 x 1.75	= 1.75
1	TOD instruction	1 x 1.00	= 1.00
3	MOV instructions	3 x 1.50	= 4.50
10	CTU instructions	10 x 1.00	= 10.00
10	RES instructions	10 x 1.00	= 10.00
Instruction Usage			<hr/> 98.00

30	rungs	30 x 0.375	= 11.25
10	data words	100 x 0.250	= 25.00
0			
10	is highest data table file number	10 x 1.00	= 10.00
4	is highest program file number	4 x 2.00	= 8.00

**User Program Total** **163.50**

49	I/O data words	49 x 0.75	= 36.75
30	slot	30 x 0.75	= 22.50
Overhead			67.00

**I/O Configuration Total** **126.25**

Estimated total memory usage: 289.75

**(round to  
290)**

4096 - 290 = 3806 instruction words remaining in the processor

## SLC 5/02 Processor

The number of instruction words used by an instruction is indicated in the following table. Since the program is compiled by the programmer, it is only possible to establish *estimates* for the instruction words used by individual instructions. The calculated memory usage will normally be greater than the actual memory usage, due to compiler optimization.

**Table C.3 SLC 5/02 List of Instructions**

<b>Mnemonic</b>	<b>Memory Usage (user words)</b>	<b>Name</b>	<b>Instruction Type</b>	<b>Page</b>
ADD	1.5	Add	Math	4-5
AND	1.5	And	Data Handling	5-20
BSL	2.00	Bit Shift Left	Application Specific	7-4
BSR	2.00	Bit Shift Right	Application Specific	7-4
CLR	1.00	Clear	Math	4-12
COP	1.50	File Copy	Data Handling	5-13
CTD	1.00	Count Down	Basic	2-14
CTU	1.00	Count Up	Basic	2-13
DCD	1.50	Decode 4 to 1 of 16	Data Handling	5-10
DDV	1.00	Double Divide	Math	4-11
DIV	1.50	Divide	Math	4-9
EQU <sup>(1)</sup>	1.50	Equal	Comparison	3-2
FFL	1.50	FIFO Load	Data Handling	5-26
FFU	1.50	FIFO Unload	Data Handling	5-26
FLL	1.50	Fill File	Data Handling	5-13
FRD	1.00	Convert from BCD	Data Handling	5-5
GEQ <sup>(1)</sup>	1.50	Greater Than or Equal	Comparison	3-4
GRT <sup>(1)</sup>	1.50	Greater Than	Comparison	3-3
IID	1.25	I/O Interrupt Disable	Interrupt	11-32
IIE	1.25	I/O Interrupt Enable	Interrupt	11-32
IIM	1.50	Immediate Input with Mask	Program Flow Control	6-8
INT	0.50	Interrupt Subroutine	Interrupt	11-34
IOM	1.50	Immediate Output with Mask	Program Flow Control	6-9
JMP	1.00	Jump to Label	Program Flow Control	6-2
JSR	1.00	Jump to Subroutine	Program Flow Control	6-3
LBL	0.50	Label	Program Flow Control	6-2
LEQ <sup>(1)</sup>	1.50	Less Than or Equal	Comparison	3-3
LES <sup>(1)</sup>	1.50	Less Than	Comparison	3-3

**Table C.3 SLC 5/02 List of Instructions (Continued)**

<b>Mnemonic</b>	<b>Memory Usage (user words)</b>	<b>Name</b>	<b>Instruction Type</b>	<b>Page</b>
LIM	1.50	Limit Test	Comparison	3-5
LFL	1.50	LIFO Load	Data Handling	5-28
LFU	1.50	LIFO Unload	Data Handling	5-28
MCR	0.50	Master Control Reset	Program Flow Control	6-6
MEQ <sup>(1)</sup>	1.50	Masked Comparison for Equal	Comparison	3-4
MOV	1.50	Move	Data Handling	5-17
MSG	34.75	Message	Communication	12-5
MUL	1.50	Multiply	Math	4-8
MVM	1.50	Masked Move	Data Handling	5-18
NEG	1.50	Negate	Data Handling	5-24
NEQ <sup>(1)</sup>	1.50	Not Equal	Comparison	3-2
NOT	1.00	Not	Data Handling	5-23
OR	1.50	Or	Data Handling	5-21
OSR	1.00	One-shot Rising	Basic	2-5
OTE	0.75	Output Energize	Basic	2-4
OTL	0.75	Output Latch	Basic	2-4
OTU	0.75	Output Unlatch	Basic	2-4
PID	23.25	Proportional Derivative	PID	9-3
REF	0.50	Refresh	Program Flow Control	6-10
RES	1.00	Reset	Basic	2-20
RET	0.50	Return from Subroutine	Program Flow Control	6-3
RPI	1.25	Reset Pending Interrupt	Interrupt	11-34
RTO	1.00	Retentive Timer	Basic	2-11
SBR	0.50	Subroutine	Program Flow Control	6-3
SCL	1.75	Scale Data	Math	4-15
SQC	2.00	Sequencer Compare	Application Specific	7-6
SQL	2.00	Sequencer Load	Application Specific	7-12
SQO	2.00	Sequencer Output	Application Specific	7-6
SQR	1.25	Square Root	Math	4-12
STD	0.50	Selectable Timer Interrupt Disable	Interrupt	11-16
STE	0.50	Selectable Timer Interrupt Enable	Interrupt	11-16
STS	1.25	Selectable Timer Interrupt Start	Interrupt	11-17
SUB	1.50	Subtract	Math	4-5
SUS	1.50	Suspend	Program Flow Control	6-8
SVC		Service Comms	Communication	12-3

**Table C.3 SLC 5/02 List of Instructions (Continued)**

<b>Mnemonic</b>	<b>Memory Usage (user words)</b>	<b>Name</b>	<b>Instruction Type</b>	<b>Page</b>
TND	0.50	Temporary End	Program Flow Control	6-7
TOD	1.00	Convert to BCD	Data Handling	5-2
TOF	1.00	Timer Off-delay	Basic	2-10
TON	1.00	Timer On-delay	Basic	2-9
XIC <sup>(1)</sup>	1.00	Examine If Closed	Basic	2-3
XIO <sup>(1)</sup>	1.00	Examine If Open	Basic	2-3
XOR	1.50	Exclusive Or	Data Handling	5-22

<sup>(1)</sup> These instructions take zero execution time if they are preceded by conditions that guarantee the state of the rung. Rung logic is solved left to right. Branches are solved top to bottom.

## Estimating Total Memory Usage of Your System Using a SLC 5/02 Processor

\_\_\_\_\_

\_\_\_\_\_

\_\_\_\_\_

\_\_\_\_\_

\_\_\_\_\_

\_\_\_\_\_

\_\_\_\_\_

\_\_\_\_\_

\_\_\_\_\_

1. Calculate the total instruction words used by the instructions in your program and enter the result. Refer to the table on page -7.
2. Multiply the total number of rungs by 0.375 and enter the result.
3. If you are using a 1747-L524 and have enabled the Single Step Test mode, multiply the total number of rung by 0.375 and enter the result.
4. Multiply the total number of data words (excluding the status file and I/O data words by 0.25 and enter the result.
5. Add 1 word for each data table file used and enter the result.
6. Multiply the highest numbered program file used by 2 and enter the result.
7. Multiply the total number of I/O data words by 0.75 and enter the result.
8. Multiply the total number of I/O slots, used or unused, by 0.75 and enter the result.
9. To account for processor overhead, enter 204
10. Total steps 1 through 9. This is the estimated total memory usage of your application system. Remember, this is an estimate, actual compiled programs may differ by  $\pm 12\%$ .

**Total:** \_\_\_\_\_

11. If you wish to determine the estimated amount of memory remaining in the processor you have selected, do the following:

If you are using a 1747-L524, subtract the total from 4096.

The result of this calculation will be the estimated total memory remaining in your selected processor.

**TIP**

The calculated memory usage may vary from the actual compiled program by  $\pm 12\%$ .

## SLC 5/02 Memory Usage Example

---

### 1747-L524 series C processor, 30-slot configuration, (15) 1746-IA16, (10) 1746-OA8, (1) 1747-DCM full configuration, (1) 1746-NI4, (1) 1746-NIO4I

50	XIC and XIO	50 x 1.00	=	50.00
15	OTE instructions	15 x 0.75	=	11.25
5	TON instructions	5 x 1.00	=	5.00
3	GRT instructions	3 x 1.50	=	4.50
1	SCL instruction	1 x 1.75	=	1.75
1	TOD instruction	1 x 1.00	=	1.00
3	MOV instructions	3 x 1.50	=	4.50
10	CTU instructions	10 x 1.00	=	10.00
10	RES instructions	10 x 1.00	=	10.00
Instruction Usage				98.00
30	rungs	30 x 0.375	=	11.25
100	data words	100 x 0.250	=	25.00
10	is highest data table file number	10 x 1.00	=	10.00
4	is highest program file number	4 x 2.00	=	8.00
<b>User Program Total</b>				<b>163.50</b>
49	I/O data words	49 x 0.75	=	36.75
30	slot	30 x 0.75	=	22.50
Overhead				204.00
<b>I/O Configuration Total</b>				<b>263.25</b>
Estimated total memory usage:				426.75
				<b>(round to 427)</b>
4096 - 290 = 3806 instruction words remaining in the processor				

## User Word Comparison Between SLC 5/03 (and higher) Processors and the SLC 5/02 Processor

The SLC 5/03 (and higher) processors and the SLC 5/02 processor accumulate user words differently during the creation of a user program. The SLC 5/02 processor is generally more efficient in its word usage than the SLC 5/03 (and higher) processors. However, the SLC 5/02 processor word usage is difficult to estimate since it is tied to the architecture of the microprocessor.

The SLC 5/03 (and higher) processors accumulate words in a way that is easier to understand and estimate than the SLC 5/02 processor. The SLC 5/03 (and higher) processors accumulate words similar to a PLC-5.

See page C-1 for user memory capacities for the various SLC processors. It is important to realize that this does not mean that a 16k, SLC 5/03 processor can hold a user program that is three times larger than an equivalent SLC 5/02 program. Use the information below to determine the SLC 5/03 user program size based on existing SLC 5/02 programs.

### Instruction Words

Some instructions use the same amount of memory, while other instructions do not use the same amount of memory. For example, a CTU instruction always uses 1 word. However, an ADD instruction in an SLC 5/02 processor uses 1.5 words; in a SLC 5/03 (or higher) processor an ADD instruction uses 3 words. Also note additional differences below:

**Table C.4 Memory Usage**

Condition	SLC 5/02 Words	SLC 5/03 Words	SLC 5/04 and SLC 5/05 Words
Each rung	0.375	1	1
Each additional Program File	1	5	5
Each additional Data File	1	5	5
Each I/O Slot	0.75	3	3
Overhead	216	236	250

Exact program content determines the program size difference. An SLC 5/03 program consumes 20% to 150% more instruction words than its SLC 5/02 equivalent.



## Data Words

### *Files 0 and 1*

In the SLC 5/02 processor, each I/O data word consumes 0.75 words of memory. In the SLC 5/03 processor, each I/O data word consumes 3 words of data.

### *File 2*

The status file word usage is contained in the overhead values for both the SLC 5/02 and SLC 5/03 processors.

### *File 3 to 255*

In the SLC 5/02 processor, 4 data words consume the same amount of memory as 1 instruction word. This is why the SLC 5/02 processor is said to offer 4K of Instruction words or 16K of Data words. This dynamic amount of Data word storage is due to the architecture of the SLC 5/02's microprocessor.

## SLC 5/03, SLC 5/04, and SLC 5/05 Processor

The following table shows memory usage times for the SLC 5/03, SLC 5/04, and SLC 5/05 processors. Instructions that support floating point are included within this table. When using a SLC 5/03 processor, it is important to remember that 1 instruction word equals 1 data word.

**Table C.5 SLC 5/03, SLC 5/04 and SLC 5/05 List of Instructions**

Mnemonic	Applies to SLC	Memory Usage (user words)	Name	Instruction Type	Page
ABL		2.00	Test Buffer for Line	ASCII	10-6
ABS		2.00	Absolute	Math	4-24
ABS	FP	2.00	Absolute	Math	4-24
ACB		2.00	Number of Characters in Buffer	ASCII	10-7
ACI		2.00	String to Integer	ASCII	10-8

Table C.5 SLC 5/03, SLC 5/04 and SLC 5/05 List of Instructions (Continued)

Mnemonic	Applies to SLC	Memory Usage (user words)	Name	Instruction Type	Page					
						OS300	OS301, OS400	OS302, OS401, OS501	OS302, OS401, OS501 Series C	OS302, OS401, OS501 Series C, FRN 10+
ACL			•	•	•	•	2.00	ASCII Clear Receive and/or Send Buffer	ASCII	10-9
ACN			•	•	•	•	3.00	String Concatenate	ASCII	10-11
ACS				•	•	•	2.00	Arc Cosine	Math	4-29
ADD		•	•	•	•	•	3.00, 4.00	Add	Math	4-5
ADD	FP			•	•	•	4.00	Add	Math	4-5
AEX			•	•	•	•	4.00	String Extract	ASCII	10-12
AHL			•	•	•	•	4.00	ASCII Handshake Lines	ASCII	10-13
AIC			•	•	•	•	2.00	Integer to String	ASCII	10-14
AND		•	•	•	•	•	3.00	And	Data Handling	5-20
ARD			•	•	•	•	3.00	ASCII Read Characters	ASCII	10-15
ARL			•	•	•	•	3.00	ASCII Read Line	ASCII	10-17
ASC			•	•	•	•	4.00	String Search	ASCII	10-18
ASN	FP			•	•	•	2.00	Arc Sine	Math	4-29
ASR			•	•	•	•	3.00	ASCII String Compare	ASCII	10-19
ATN	FP			•	•	•	2.00	Arc Tangent	Math	4-30
AWA			•	•	•	•	3.00	ASCII Write with Append	ASCII	10-20
AWT			•	•	•	•	3.00	ASCII Write	ASCII	10-22
BSL		•	•	•	•	•	3.00	Bit Shift Left	Application Specific	7-4
BSR		•	•	•	•	•	3.00	Bit Shift Right	Application Specific	7-4
BTR					•	•	5.00	Block Transfer Read	Block Transfer	8-1
BTW					•	•	5.00	Block Transfer Write	Block Transfer	8-1
CEM						•	73.00	ControlNet Explicit Message	Communication	12-45
CLR		•	•	•	•	•	3.00, 1.00	Clear	Math	4-12
CLR	FP			•	•	•	1.00	Clear	Math	4-12
COP		•	•	•	•	•	3.00	File Copy	Data Handling	5-13
COS	FP			•	•	•	2.00	Cosine	Math	4-30
CPT				•	•	•	(1)	Compute	Math	4-25
CTD		•	•	•	•	•	1.00	Count Down	Basic	2-14
CTU		•	•	•	•	•	1.00	Count Up	Basic	2-13

Table C.5 SLC 5/03, SLC 5/04 and SLC 5/05 List of Instructions (Continued)

Mnemonic	Applies to SLC	Memory Usage (user words)	Name	Instruction Type	Page	
						OS300
DCD		• • • • •	2.00	Decode 4 to 1 of 16	Data Handling	5-10
DDV		• • • • •	2.00	Double Divide	Math	4-11
DDT		• • • • •	6.00	Diagnostic Detect	Application Specific	7-18
DEG	FP	• • • • •	2.00	Degree	Data Handling	5-8
DEM		• • • • •	74.00	DeviceNet Explicit Message	Communication	12-52
DIV		• • • • •	3.00, 4.00	Divide	Math	4-9
DIV	FP	• • • • •	4.00	Divide	Math	4-9
EEM		• • • • •	64.00	Ethernet/IP Explicit Message	Communication	12-58
ENC		• • • • •	2.00	Encode 1 of 16 to 4	Data Handling	5-11
EQU		• • • • •	3.00	Equal	Comparison	3-2
EQU	FP	• • • • •	3.00	Equal	Comparison	3-2
FBC		• • • • •	6.00	File Bit Comparison	Application Specific	7-18
FFL		• • • • •	3.00	FIFO Load	Data Handling	5-26
FFU		• • • • •	4.00	FIFO Unload	Data Handling	5-26
FLL		• • • • •	3.00	Fill File	Data Handling	5-13
FRD		• • • • •	2.00	Convert from BCD	Data Handling	5-5
GEQ		• • • • •	3.00	Greater Than or Equal	Comparison	3-4
GEQ	FP	• • • • •	3.00	Greater Than or Equal	Comparison	3-4
GRT		• • • • •	3.00	Greater Than	Comparison	3-3
GRT	FP	• • • • •	3.00	Greater Than	Comparison	3-3
IID		• • • • •	2.00	I/O Interrupt Disable	Interrupt	11-32
IIE		• • • • •	2.00	I/O Interrupt Enable	Interrupt	11-32
IIM		• • • • •	6.00	Immediate Input with Mask	Program Flow Control	6-8
INT		• • • • •	1.00	Interrupt Subroutine	Interrupt	11-34
IOM		• • • • •	6.00	Immediate Output with Mask	Program Flow Control	6-9
JMP		• • • • •	1.00	Jump to Label	Program Flow Control	6-2
JSR		• • • • •	1.00	Jump to Subroutine	Program Flow Control	6-3
LBL		• • • • •	2.00	Label	Program Flow Control	6-2
LEQ		• • • • •	3.00	Less Than or Equal	Comparison	3-3

Table C.5 SLC 5/03, SLC 5/04 and SLC 5/05 List of Instructions (Continued)

Mnemonic  FP = floating point		Applies to SLC					Memory Usage (user words)	Name	Instruction Type	Page
		OS300	OS301, OS400	OS302, OS401, OS501	OS302, OS401, OS501 Series C	OS302, OS401, OS501 Series C, FRN 10+				
LEQ	FP		•	•	•	•	3.00	Less Than or Equal	Comparison	3-3
LES		•	•	•	•	•	3.00	Less Than	Comparison	3-3
LES	FP		•	•	•	•	3.00	Less Than	Comparison	3-3
LFL		•	•	•	•	•	3.00	LIFO Load	Data Handling	5-28
LFU		•	•	•	•	•	3.00	LIFO Unload	Data Handling	5-28
LIM		•	•	•	•	•	1.00	Limit Test	Comparison	3-5
LIM	FP		•	•	•	•	1.00	Limit Test	Comparison	3-5
LN	FP			•	•	•	2.00	Natural Log	Math	4-31
LOG	FP			•	•	•	2.00	Log to the Base 10	Math	4-31
MCR		•	•	•	•	•	1.00	Master Control Reset	Program Flow Control	6-6
MEQ		•	•	•	•	•	4.00	Masked Comparison for Equal	Comparison	3-4
MOV		•	•	•	•	•	2.00	Move	Data Handling	5-17
MOV	FP		•	•	•	•	2.00	Move	Data Handling	5-17
MSG		•	•	•	•	•	20.00	Message	Communication	12-5
MUL		•	•	•	•	•	3.00	Multiply	Math	4-8
MUL	FP			•	•	•	3.00	Multiply	Math	4-8
MVM		•	•	•	•	•	3.00, 4.00	Masked Move	Data Handling	5-18
NEG		•	•	•	•	•	3.00	Negate	Data Handling	5-24
NEG	FP			•	•	•	3.00	Negate	Data Handling	5-24
NEQ		•	•	•	•	•	3.00	Not Equal	Comparison	3-2
NEQ	FP		•	•	•	•	3.00	Not Equal	Comparison	3-2
NOT		•	•	•	•	•	3.00	Not	Data Handling	5-23
OR		•	•	•	•	•	3.00	Or	Data Handling	5-21
OTE		•	•	•	•	•	1.00	Output Energize	Basic	2-4
OTL		•	•	•	•	•	1.00	Output Latch	Basic	2-4
OTU		•	•	•	•	•	1.00	Output Unlatch	Basic	2-4
PID		•	•	•	•	•	26.00	Proportional Integral Derivative	PID	9-1
RAD	FP			•	•	•	2.00	Radian	Data Handling	5-9
REF		•	•	•	•	•	1.00	I/O Refresh	Program Flow Control	6-10

Table C.5 SLC 5/03, SLC 5/04 and SLC 5/05 List of Instructions (Continued)

Mnemonic	Applies to SLC	Memory Usage (user words)	Name	Instruction Type	Page			
						OS300	OS301, OS400	OS302, OS401, OS501
RES		• • • • •	1.00	Reset	Basic	2-20		
RET		• • • • •	1.00	Return from Subroutine	Program Flow Control	6-3		
RHC				• •	2.00	Read High Speed Clock	Application Specific	7-17
RMP				• •	2.00	Ramp	Math	4-20
RPC				•	3.00	Read Program Checksum	Application Specific	7-23
RPI		• • • • •	2.00	Reset Pending Interrupt	Interrupt	11-34		
RTO		• • • • •	1.00	Retentive Timer	Basic	2-11		
SBR		• • • • •	1.00	Subroutine	Program Flow Control	6-3		
SCL	FP			• • •	4.00	Scale Data	Math	4-15
SCP				• • •	6.00	Scale with Parameters	Math	4-13
SCP	FP			• • •	6.00	Scale with Parameters	Math	4-13
SIN	FP			• • •	2.00	Sine	Math	4-32
SQC		• • • • •	5.00	Sequencer Compare	Application Specific	7-6		
SQL		• • • • •	4.00	Sequencer Load	Application Specific	7-12		
SQO		• • • • •	5.00	Sequencer Output	Application Specific	7-6		
SQR		• • • • •	2.00, 3.00	Square Root	Math	4-12		
SQR	FP			• • •	3.00	Square Root	Math	4-12
STD		• • • • •	1.00	Selectable Timer Interrupt Disable	Interrupt	11-16		
STE		• • • • •	1.00	Selectable Timer Interrupt Enable	Interrupt	11-16		
STS		• • • • •	3.00	Selectable Timer Interrupt Start	Interrupt	11-17		
SUB		• • • • •	3.00	Subtract	Math	4-5		
SUB	FP			• • •	4.00	Subtract	Math	4-5
SUS		• • • • •	2.00	Suspend	Program Flow Control	6-8		
SVC		• • • • •	1.00	Service Communication	Communication	12-3		
SWP				• • •	2.00	SWAP	Math	4-28
TAN	FP			• • •	2.00	Tangent	Math	4-32
TDF				• •	3.00	Compute Time Difference	Application Specific	7-17
TND		• • • • •	1.00	Temporary End	Program Flow Control	6-7		
TOD		• • • • •	2.00	Convert to BCD	Data Handling	5-2		

**Table C.5 SLC 5/03, SLC 5/04 and SLC 5/05 List of Instructions (Continued)**

Mnemonic	Applies to SLC	Memory Usage (user words)	Name	Instruction Type	Page	
						OS300
TOF		• • • • •	1.00	Timer Off-delay	Basic	2-10
TON		• • • • •	1.00	Timer On-delay	Basic	2-9
XIC		• • • • •	1.00	Examine If Closed	Basic	2-3
XIO		• • • • •	1.00	Examine If Open	Basic	2-3
XOR		• • • • •	3.00	Exclusive Or	Data Handling	5-22
XPY	FP	• • •	3.00	X to the Power of Y	Math	4-33

(1) To calculate the memory usage, do the following: Take 2 plus the number of instruction words for each operation performed plus the number of operations performed in the compute. For example, 2 + ADD + SUB + 2 =10.

## Estimating Total Memory Usage of Your System Using an SLC 5/03, SLC 5/04, or SLC 5/05 Processor

- |  |   |
|--|---|
| _____<br>_____<br>_____<br>_____<br>_____<br><b>Subtotal:</b> _____<br><b>4096</b><br><b>- (step 7 value)</b><br>_____<br>_____<br>_____<br>_____<br>Subtotal: _____<br>_____<br>_____<br>Total: _____ | <ol style="list-style-type: none"> <li><b>1.</b> Add the total number of data file words used (excluding the status file and I/O data words) and enter the result.</li> <li><b>2.</b> Multiply the total number of I/O data words by 3 and enter the result.</li> <li><b>3.</b> Multiply the total number of I/O slots, used or unused, by 3 and enter the result.</li> <li><b>4.</b> To account for processor overhead, enter 236.</li> <li><b>5.</b> Multiply the highest numbered program file used by 5 and enter the result.</li> <li><b>6.</b> Multiply the highest numbered program file used by 5 and enter the result.</li> <li><b>7.</b> Add steps 1 through 6. Enter this as the subtotal (additional 4K word usage).</li> <li><b>8.</b> Subtract the value in step 7 from 4096; if the result is positive, enter 12,288 in step 14. If the result is negative, subtract the absolute value from 12,288 and enter the result in step 14. (This decreases the value.)</li> <li><b>9.</b> Calculate the total number of words used by the instructions in your program and enter the result. Refer to Table C.5 on page C-13.</li> <li><b>10.</b> Add the total number of rungs (1 word per rung) and enter the result.</li> <li><b>11.</b> Add 1 word for each indexed address reference and enter the result.</li> <li><b>12.</b> Add 2 words per rung for each rung that contains an indexed address reference and enter the result</li> <li><b>13.</b> Add steps 9 through 12 and enter the result.</li> <li><b>14.</b> Enter the result from step 8. This is the available memory.</li> <li><b>15.</b> Enter the result from step 13. This is the total number of words used.</li> <li><b>16.</b> Subtract step 15 from step 14. This number is the amount of memory available to your system.</li> </ol> |
|--|---|

### SLC 5/03, SLC 5/04, or SLC 5/05 Memory Usage Example

**1747-L532 processor, 30-slot configuration, (15) 1746-IA16, (10) 1746-OA8, (1) 1747-DCM full configuration, (1) 1746-NI4, (1) 1746-NIO4I**

100	data words	100 x 1.00	= 100.00
49	I/O data words	49 x 3.00	= 147.00
30	slot	30 x 3.00	= 90.00
	Overhead		236.00
10	is the highest data table file number	10 x 5.00	= 50.00
4	is the highest program file number	4 x 5.00	= 20.00
<b>Subtotal</b>			<b>643.00</b>

Account for additional 4K data space

4096 - 643 = 3453 (result is positive; therefore  
**12,288** words are available)

50	XIC and XIO	50 x 1.00	= 50.00
15	OTE instructions	15 x 1.00	= 15.00
5	TON instructions	5 x 1.00	= 5.00
3	GRT instructions	3 x 3.00	= 9.00
1	SCL instruction	1 x 4.00	= 4.00
t	TOD instruction	1 x 2.00	= 2.00
3	MOV instructions	3 x 2.00	= 6.00
10	CTU instructions	10 x 1.00	= 10.00
10	RES instructions	10 x 1.00	= 10.00
Instruction USage			<b>111.00</b>

30	rungs	30 x 1.00	= <b>30.00</b>
0	indexed address		= 0.00
0	indexed address reference		0.00
<b>Subtotal</b>			<b>141.00</b>

Available memory	12,288.00
Words used	- 141.00

Estimated total memory available: **12,147.00**



## Programming Instruction References

This appendix lists all of the available programming instructions along with their parameters, valid addressing modes, and file types.

### Valid Addressing Modes and File Types

The following addressing modes are available.

**Table D.1 Available Addressing Modes**

Addressing Mode	Example
Direct	N7:0
Indexed Direct	#N7:0
Indirect	N7:[N10:3]
Indexed Indirect	#N7:[N10:3]

The following file types are available.

**Table D.2 Available File Types**

Abbreviation	File Type
O	Output
I	Input
S	Status
B	Binary
T	Timer
C	Counter
R	Control
N	Integer
F	Float <sup>(1)(2)</sup>
A	ASCII <sup>(1)(2)</sup>
ST	String <sup>(1)(2)</sup>
M	M0/M1 <sup>(3)</sup>
Immediate	indicates that a constant is a valid file type

<sup>(1)</sup> Supported only by SLC 5/03 (OS301 and higher), SLC 5/04, and SLC 5/05 processors.

<sup>(2)</sup> Not supported by Fixed SLC, SLC 5/01, and SLC 5/02 processors.

<sup>(3)</sup> Not supported by Fixed SLC and SLC 5/01 processors.

## Understanding the Different Addressing Modes

The following descriptions will help you understand how to structure a specific type of address.

### *Direct Addressing*

The data stored in the specified address is used in the instruction. For example:

N7:0  
ST20:5  
T4:8.ACC

### *Indexed Addressing*

You may specify an address as being indexed by placing the “#” character in front of the address. When an address of this form is encountered in the program, the processor takes the element number of the address and adds to it the value contained in the Index Register S:24, then uses the result as the actual address. For example:

#N7:10 where S:24 = 15  
The actual address used by the instruction is N7:25.

### *Indirect Addressing*

You may specify an address as being indirect by replacing the file number, element number, or sub-element number with a [Xf:e.s] symbol. The word address inside of the bracket is queried for a value. The queried value then becomes the file, element, or sub-element portion of the indirect address. For example:

B3:[N10:2] states that the element address of Bit file 3 is contained in address N10:2. Therefore, if N10:2 contains the value 5, B3:[N10:2] indirectly refers to address B3:5. Other examples include:

N7:[N7:0]  
N7:[T4:0.ACC]  
N[N7:0]:[N7:1]  
C5:[N7:0]

### *Indexed Indirect Addressing*

You may specify a combination of indirect and indexed addressing. The processor first resolves the indirect portion of the address and then adds the offset from the Index Register S:24 to come up with the final address. For example:

#N7:[N10:3] where N10:3 = 20 and S:24 = 15  
 The actual address used by the instruction is N7:35.

**Table D.3 Available Addressing Modes**

Instruction	Description	Instruction Parameter	Valid Addressing Mode(s)	Valid File Types	Immediate Values
ABL <sup>(1)</sup>	ASCII Test Buffer for Line	channel			0
		control	direct	R	none
		characters			0-1024
ABS <sup>(2)</sup>	Absolute Value	source	direct, indexed direct indirect, indexed indirect	O, I, S, B, T, C, R, N, F, A, ST, M	-32,768 to 32,767 f-min to f-max
		destination	direct, indexed direct indirect, indexed indirect	O, I, S, B, T, C, R, N, F, A, ST, M	none
ACB <sup>(1)</sup>	ASCII Number of Characters in Buffer	channel			0
		control	direct	R	none
		characters			0 to 1024
ACI <sup>(1)</sup>	ASCII String to Integer	source	direct, indirect	ST	none
		destination	direct, indexed direct indirect, indexed indirect	O, I, S, B, T, C, R, N, A, ST, M	none
ACL <sup>(1)</sup>	ASCII Clear Buffer	channel			0
		transmit buffer			0=no or 1=yes
		receive buffer			0=no or 1=yes
ACN <sup>(1)</sup>	ASCII String Concatenate	source A	direct, indirect	ST	none
		source B	direct, indirect	ST	none
		destination	direct	ST	none
ACS <sup>(2)</sup>	Arc Cosine	source	direct, indexed direct indirect, indexed indirect	O, I, S, B, T, C, R, N, F, A, ST, M	-32,768 to 32,767 f-min to f-max
		destination	direct, indexed direct indirect, indexed indirect	O, I, S, B, T, C, R, N, F, A, ST, M	none
ADD	Add	source A	direct, indexed direct indirect, indexed indirect	O, I, S, B, T, C, R, N, F, A, ST, M	-32,768 to 32,767 f-min to f-max
		source B	direct, indexed direct indirect, indexed indirect	O, I, S, B, T, C, R, N, F, A, ST, M	-32,768 to 32,767 f-min to f-max
		destination	direct, indexed direct indirect, indexed indirect	O, I, S, B, T, C, R, N, F, A, ST, M	none
AEX <sup>(1)</sup>	ASCII String Extract	source	direct, indirect	ST	none
		index	direct, indexed direct indirect, indexed indirect	O, I, S, B, T, C, R, N, A, ST, M	1 to 82
		number	direct, indexed direct indirect, indexed indirect	O, I, S, B, T, C, R, N, A, ST, M	1 to 82
		destination	direct	ST	none

**Table D.3 Available Addressing Modes (Continued)**

<b>Instruction</b>	<b>Description</b>	<b>Instruction Parameter</b>	<b>Valid Addressing Mode(s)</b>	<b>Valid File Types</b>	<b>Immediate Values</b>
AHL <sup>(1)</sup>	ASCII Set/Reset Handshake Lines	channel			0
		AND mask	direct, indexed direct indirect, indexed indirect	O, I, S, B, T, C, R, N, A, ST, M	0 to FFFF
		OR mask	direct, indexed direct indirect, indexed indirect	O, I, S, B, T, C, R, N, A, ST, M	0 to FFFF
		control	direct	R	none
		channel status			0 to 001F
AIC <sup>(1)</sup>	ASCII Integer to String	source	direct, indexed direct indirect, indexed indirect	O, I, S, B, T, C, R, N, A, ST, M	-32,768 to 32,767
		destination	direct	ST	none
AND	Logical AND	source A	direct, indexed direct indirect, indexed indirect	O, I, S, B, T, C, R, N, A, ST, M	-32,768 to 32,767
		source B	direct, indexed direct indirect, indexed indirect	O, I, S, B, T, C, R, N, A, ST, M	-32,768 to 32,767
		destination	direct, indexed direct indirect, indexed indirect	O, I, S, B, T, C, R, N, A, ST, M	none
ARD <sup>(1)</sup>	ASCII Read Characters	channel			0
		destination	direct	ST	none
		control	direct	R	none
		string length			0 to 82
		characters read			0 to 82
ARL <sup>(1)</sup>	ASCII Read Line	channel			0
		destination	direct	ST	none
		control	direct	R	none
		string length			0 to 82
		characters read			0 to 82
ASC <sup>(1)</sup>	ASCII String Search	source	direct, indirect	ST	none
		index	direct, indexed direct indirect, indexed indirect	O, I, S, B, T, C, R, N, A, ST, M	1 to 82
		search	direct, indirect	ST	none
		result	direct, indexed direct indirect, indexed indirect	O, I, S, B, T, C, R, N, A, ST, M	none
ASN <sup>(2)</sup>	Arc Sine	source	direct, indexed direct indirect, indexed indirect	O, I, S, B, T, C, R, N, F, A, ST, M	-32,768 to 32,767 f-min to f-max
		destination	direct, indexed direct indirect, indexed indirect	O, I, S, B, T, C, R, N, F, A, ST, M	none
ASR <sup>(1)</sup>	ASCII String Compare	source A	direct, indirect	ST	none
		source B	direct, indirect	ST	none

**Table D.3 Available Addressing Modes (Continued)**

<b>Instruction</b>	<b>Description</b>	<b>Instruction Parameter</b>	<b>Valid Addressing Mode(s)</b>	<b>Valid File Types</b>	<b>Immediate Values</b>
ATN <sup>(2)</sup>	Arc Tangent	source	direct, indexed direct indirect, indexed indirect	O, I, S, B, T, C, R, N, F, A, ST, M	-32,768 to 32,767 f-min to f-max
		destination	direct, indexed direct indirect, indexed indirect	O, I, S, B, T, C, R, N, F, A, ST, M	none
AWA <sup>(1)</sup>	ASCII Write with Append	channel			0
		source	direct	ST	none
		control	direct	R	none
		string length			0 to 82
		characters sent			0 to 82
AWT <sup>(1)</sup>	ASCII Write	channel			0
		source	direct	ST	none
		control	direct	R	none
		string length			0 to 82
		characters sent			0 to 82
BSL	Bit Shift Left	file	indexed direct indexed indirect	O, I, S, B, N, A, ST	none
		control	direct	R	none
		bit address	direct, indirect	O, I, S, B, T, C, R, N, A, ST, M	none
		length			0 to 2048
BSR	Bit Shift Right	file	indexed direct indexed indirect	O, I, S, B, N, A, ST	none
		control	direct	R	none
		bit address	direct, indirect	O, I, S, B, T, C, R, N, A, ST, M	none
		length			0 to 2048
BTR	Block Transfer Read	control	direct	N	
		source "Data"	direct	I, O, S, B, N, A, F	
		buffer	direct M1 file address	M	
BTW	Block Transfer Write	control	direct	N	
		source "Data"	direct	I, O, S, B, N, A, F	
		buffer	direct M0 file address	M	

**Table D.3 Available Addressing Modes (Continued)**

Instruction	Description	Instruction Parameter	Valid Addressing Mode(s)	Valid File Types	Immediate Values
CEM	ControlNet Explicit Message	control block	direct	N	none
		control block length			67
		1747-SCNR slot			1 to 30
		size in words (receive data)			0 to 248
		size in words (send data)			0 to 248
		data table address (receive data)	direct	N	none
		data table address (send data)	direct	N	none
		message timeout (x1 ms)			2 to 32767
		ControlNet address			1 to 99
		service			
		service code (hex)			1 to 7F
		class (hex)			0 to FF
		instance (hex)			0 to FFFF
		attribute (hex)			0 to FFFF
member (hex)			0 to FFFF		
CLR	Clear	destination	direct, indexed direct indirect, indexed indirect	O, I, S, B, T, C, R, N, F, A, ST, M	none
COP	Copy File	source	indexed direct indexed indirect	O, I, S, B, T, C, R, N, F, A, ST, M	none
		destination	indexed direct indexed indirect	O, I, S, B, T, C, R, N, F, A, ST, M	none
		length			1 to 128
COS <sup>(2)</sup>	Cosine	source	direct, indexed direct indirect, indexed indirect	O, I, S, B, T, C, R, N, F, A, ST, M	-32,768 to 32,767 f-min to f-max
		destination	direct, indexed direct indirect, indexed indirect	O, I, S, B, T, C, R, N, F, A, ST, M	none
CPT <sup>(2)</sup>	Compute	destination	direct, indexed direct indirect, indexed indirect	O, I, S, B, T, C, R, N, F, A, ST, M	none
		expression			<expression>

**Table D.3 Available Addressing Modes (Continued)**

Instruction	Description	Instruction Parameter	Valid Addressing Mode(s)	Valid File Types	Immediate Values
CTD	Count Down	counter	direct	C	none
		preset			-32,768 to 32,767
		accum			-32,768 to 32,767
CTU	Count Up	counter	direct	C	none
		preset			-32,768 to 32,767
		accum			-32,768 to 32,767
DCD	Decode 4 to 1 of 16	source	direct, indexed direct indirect, indexed indirect	O, I, S, B, T, C, R, N, A, ST, M	none
		destination	direct, indexed direct indirect, indexed indirect	O, I, S, B, T, C, R, N, A, ST, M	none
DDV	Double Divide	source	direct, indexed direct indirect, indexed indirect	O, I, S, B, T, C, R, N, A, ST, M	-32,768 to 32,767
		destination	direct, indexed direct indirect, indexed indirect	O, I, S, B, T, C, R, N, A, ST, M	none
DDT	Diagnostic Detect	control	direct	R	
		source "file"	index direct	I, O, S, B, N, A	
		reference "file"	index direct	I, O, S, B, N, A	
		result "file"	index direct	I, O, S, B, N, A	
DEG <sup>(2)</sup>	Radians to Degrees	source	direct, indexed direct indirect, indexed indirect	O, I, S, B, T, C, R, N, F, A, ST, M	-32,768 to 32,767 f-min to f-max
		destination	direct, indexed direct indirect, indexed indirect	O, I, S, B, T, C, R, N, F, A, ST, M	none
DEM	DeviceNet Explicit Message	control block	direct	N	none
		control block length			70
		1747-SDN slot			0 to 30
		size of send data (bytes)			0 to 52
		message timeout (x1 sec)			0 to 255
		DeviceNet address			0 to 63
		service			
		service code (hex)			1 to 7F
		class (hex)			0 to FF
		instance (hex)			0 to FFFF
attribute (hex)			0 to FF		

**Table D.3 Available Addressing Modes (Continued)**

Instruction	Description	Instruction Parameter	Valid Addressing Mode(s)	Valid File Types	Immediate Values
DIV	Divide	source A	direct, indexed direct indirect, indexed indirect	O, I, S, B, T, C, R, N, F, A, ST, M	-32,768 to 32,767 f-min to f-max
		source B	direct, indexed direct indirect, indexed indirect	O, I, S, B, T, C, R, N, F, A, ST, M	-32,768 to 32,767 f-min to f-max
		destination	direct, indexed direct indirect, indexed indirect	O, I, S, B, T, C, R, N, F, A, ST, M	none
EEM	EtherNet/IP Explicit Message	control block	direct	N	none
		control block length			58
		size in words (receive data)			0 to 124
		size in words (send data)			0 to 124
		data table address (receive data)	direct	N	none
		data table address (send data)	direct	N	none
		service			
		service code (hex)			1 to 7F
		class (hex)			0 to FFFF
		instance (hex)			0 to FFFF
		attribute (hex)			0 to FF
ENC	Encode 1 of 16 to 4	source	direct, indirect, index, indirect index	I, O, S, B, N, A, T	
		destination	direct, indirect, index, indirect index	I, O, S, B, N, A, C, R	
EQU	Equal	source A	direct, indexed direct indirect, indexed indirect	O, I, S, B, T, C, R, N, F, A, ST, M	none
		source B	direct, indexed direct indirect, indexed indirect	O, I, S, B, T, C, R, N, F, A, ST, M	-32,768 to 32,767 f-min to f-max
FBC	File Bit Comparison	control	direct	R	
		source "file"	index direct	I, O, S, B, N, A	
		reference "file"	index direct	I, O, S, B, N, A	
		result "file"	index direct	I, O, S, B, N, A	



**Table D.3 Available Addressing Modes (Continued)**

<b>Instruction</b>	<b>Description</b>	<b>Instruction Parameter</b>	<b>Valid Addressing Mode(s)</b>	<b>Valid File Types</b>	<b>Immediate Values</b>
FFL <sup>(3)</sup>	FIFO Load	source	direct, indexed direct indirect, indexed indirect	O, I, S, B, T, C, R, N, A, ST, M <sup>(4)</sup>	-32,768 to 32,767
		FIFO array	indexed direct indexed indirect	O, I, S, B, N, A	none
		FIFO control	direct	R	none
		length			1 to 128
		position			0 to 127
FFU <sup>(3)</sup>	FIFO Unload	FIFO array	indexed direct indexed indirect	O, I, S, B, N, A	none
		destination	direct, indexed direct indirect, indexed indirect	O, I, S, B, T, C, R, N, A, ST, M <sup>(4)</sup>	none
		FIFO control	direct	R	none
		length			1 to 128
		position			0 to 127
FLL	Fill File	source	direct, indirect	O, I, S, B, T, C, R, N, F, A, ST, M	-32,768 to 32,767 f-min to f-max
		destination	indexed direct indexed indirect	O, I, S, B, T, C, R, N, F, A, ST, M	none
		length			1 to 128
FRD	From BCD to Binary	source (SLC 5/01)	direct	O, I, S, B, T, C, R, N, A, ST, M	none
		source (SLC 5/02, 5/03, 5/04, 5/05)	direct, indexed direct indirect, indexed indirect	O, I, S, B, T, C, R, N	none
		destination	direct, indexed direct indirect, indexed indirect	O, I, S, B, T, C, R, N, A, ST, M	none
GEQ	Greater Than or Equal	source A	direct, indexed direct indirect, indexed indirect	O, I, S, B, T, C, R, N, F, A, ST, M	none
		source B	direct, indexed direct indirect, indexed indirect	O, I, S, B, T, C, R, N, F, A, ST, M	-32,768 to 32,767 f-min to f-max
GRT	Greater Than	source A	direct, indexed direct indirect, indexed indirect	O, I, S, B, T, C, R, N, F, A, ST, M	none
		source B	direct, indexed direct indirect, indexed indirect	O, I, S, B, T, C, R, N, F, A, ST, M	-32,768 to 32,767 f-min to f-max

**Table D.3 Available Addressing Modes (Continued)**

Instruction	Description	Instruction Parameter	Valid Addressing Mode(s)	Valid File Types	Immediate Values
HSC <sup>(5)</sup>	High-speed Counter (SLC 5/01)	counter			none
		preset			1 to 32,767
		counter	direct	C	none
		preset			-32,768 to 32,767
		accum			-32,768 to 32,767
		source	direct	B and N	none
		length			always 5
IID <sup>(6)</sup>	I/O Interrupt Disable	slots			double hex word (list of slots)
IIE <sup>(6)</sup>	I/O Interrupt Enable	slots			double hex word (list of slots)
IIM	Immediate Input with Mask	slot	direct	I	none
		mask	direct, indexed direct indirect, indexed indirect	O, I, S, B, T, C, R, N, A, ST, M	-32,768 to 32,767
		length (SLC 5/03, 5/04, and 5/05)			1 to 32
INT <sup>(3)</sup>	I/O Interrupt				none
IOM	Immediate Output with Mask	slot	direct	O	none
		mask	direct, indexed direct indirect, indexed indirect	O, I, S, B, T, C, R, N, A, ST, M	-32,768 to 32,767
		length (SLC 5/03, 5/04, and 5/05)			1 to 32
JMP	Jump	label number			0 to 999
JSR	Jump to Subroutine	subroutine file number			3 to 255
LBL	Label Declaration	label number			0 to 999
LEQ	Less Than or Equal To	source A	direct, indexed direct indirect, indexed indirect	O, I, S, B, T, C, R, N, F, A, ST, M	none
		source B	direct, indexed direct indirect, indexed indirect	O, I, S, B, T, C, R, N, F, A, ST, M	-32,768 to 32,767 f-min to f-max
LES	Less Than	source A	direct, indexed direct indirect, indexed indirect	O, I, S, B, T, C, R, N, F, A, ST, M	none
		source B	direct, indexed direct indirect, indexed indirect	O, I, S, B, T, C, R, N, F, A, ST, M	-32,768 to 32,767 f-min to f-max

**Table D.3 Available Addressing Modes (Continued)**

<b>Instruction</b>	<b>Description</b>	<b>Instruction Parameter</b>	<b>Valid Addressing Mode(s)</b>	<b>Valid File Types</b>	<b>Immediate Values</b>
LFL <sup>(3)</sup>	LIFO Load	source	direct, indexed direct indirect, indexed indirect	O, I, S, B, T, C, R, N, A, ST, M <sup>(4)</sup>	-32,768 to 32,767
		LIFO array	indexed direct indexed indirect	O, I, S, B, N, A	none
		LIFO control	direct	R	none
		length			1 to 128
		position			0 to 127
LFU <sup>(3)</sup>	LIFO Unload	LIFO array	indexed direct indexed indirect	O, I, S, B, N, A	none
		destination	direct, indexed direct indirect, indexed indirect	O, I, S, B, T, C, R, N, A, ST, M <sup>(4)</sup>	none
		LIFO control	direct	R	none
		length			1 to 128
		position			0 to 127
LIM <sup>(3)</sup>	Limit Test (circ)	low limit	direct, indexed direct indirect, indexed indirect	O, I, S, B, T, C, R, N, F, A, ST, M	-32,768 to 32,767 f-min to f-max
		test	direct, indexed direct indirect, indexed indirect	O, I, S, B, T, C, R, N, F, A, ST, M	-32,768 to 32,767 f-min to f-max
		high limit	direct, indexed direct indirect, indexed indirect	O, I, S, B, T, C, R, N, F, A, ST, M	-32,768 to 32,767 f-min to f-max
LN <sup>(2)</sup>	Natural Log	source	direct, indexed direct indirect, indexed indirect	O, I, S, B, T, C, R, N, F, A, ST, M	-32,768 to 32,767 f-min to f-max
		destination	direct, indexed direct indirect, indexed indirect	O, I, S, B, T, C, R, N, F, A, ST, M	none
LOG <sup>(2)</sup>	Log to the Base 10	source	direct, indexed direct indirect, indexed indirect	O, I, S, B, T, C, R, N, F, A, ST, M	-32,768 to 32,767 f-min to f-max
		destination	direct, indexed direct indirect, indexed indirect	O, I, S, B, T, C, R, N, F, A, ST, M	none
MCR	Master Control Relay				none
MEQ	Mask Compare Equal To	source	direct, indexed direct indirect, indexed indirect	O, I, S, B, T, C, R, N, A, ST, M	none
		source mask	direct, indexed direct indirect, indexed indirect	O, I, S, B, T, C, R, N, A, ST, M	-32,768 to 32,767
		compare	direct, indexed direct indirect, indexed indirect	O, I, S, B, T, C, R, N, A, ST, M	-32,768 to 32,767
MOV	Move	source	direct, indexed direct indirect, indexed indirect	O, I, S, B, T, C, R, N, F, A, ST, M	-32,768 to 32,767 f-min to f-max
		destination	direct, indexed direct indirect, indexed indirect	O, I, S, B, T, C, R, N, F, A, ST, M	none

**Table D.3 Available Addressing Modes (Continued)**

<b>Instruction</b>	<b>Description</b>	<b>Instruction Parameter</b>	<b>Valid Addressing Mode(s)</b>	<b>Valid File Types</b>	<b>Immediate Values</b>
MSG (5/02 only)	Message	read/write			0=read,1=write
		target device			2=500CPU, 4=485CIF
		control block	direct	N	none
		control block length			7
		local address	direct	O, I, S, B, T, C, R, N, A	none
		target node			0 to 31
		target address	direct	O, I, S, B, T, C, R, N, A	0 to 255
		message length		T, C, R	1 to 13
				I, O, S, B, N	1 to 41

**Table D.3 Available Addressing Modes (Continued)**

Instruction	Description	Instruction Parameter	Valid Addressing Mode(s)	Valid File Types	Immediate Values
MSG (5/03, 5/04, and 5/05 <sup>(7)</sup> )	Message	type			64=peer-to-peer
		read/write			0=read, 1=write
		target device			2=500CPU, 4=485CIF, 8=PLC5
		local/remote			16=local, 32=remote
		control block	direct	N	none
		control block length			14 <sup>(8)</sup>
		channel number			5/03 and 5/04: 0 or 1 5/05: 0 only
		target node			0 to 31, 0 to 254 if 485CIF
		remote bridge link ID			0 to 254, 0 when local
		remote bridge node address			0 to 254, 0 when local
		local bridge node address			0 to 254, 0xFFFF when local
		local file address	direct	O, I, S, B, T, C, R, N, F, A, ST, M <sup>(9)</sup>	none
		target file address	direct	O, I, S, B, T, C, R, N, F, A, ST, M <sup>(9)</sup>	0 to 255
		message length		O, I, B, N, A <sup>(9)</sup>	1 to 103
				S <sup>(9)</sup>	5/03 and 5/05: 1 to 83 5/04: 1 to 164
				F <sup>(9)</sup>	1 to 51
				T	1 to 34 (if PLC5: 1 to 20)
				C, R	1 to 34
		ST <sup>(9)</sup>	2 (if PLC5: 1)		
	message timeout			0 to 255 (SLC 5/05-23 seconds, read only)	

**Table D.3 Available Addressing Modes (Continued)**

Instruction	Description	Instruction Parameter	Valid Addressing Mode(s)	Valid File Types	Immediate Values	
MSG (5/05 Ethernet)	Message	type			64=peer-to-peer	
		read/write			0=read, 1=write	
		target device			2=500CPU, 4=485CIF, 8=PLC5	
		local			16=local	
		control block	direct	N	none	
		control block length			51 (93 if logical ASCII addressing is used)	
		channel number			1 (Ethernet)	
		target node, remote bridge link ID, local and remote bridge node address	not applicable			
		IP address (www.xx.yy.zz)			any legal IP address	
		local file address	direct	O, I, S, B, T, C, R, N, F, A, ST, M	none	
		target file address	direct	O, I, S, B, T, C, R, N, F, A, ST, M	0 to 255	
		message timeout			0 to 255	

- (1) Supported only by SLC 5/03 (OS301 and higher), SLC 5/04, and SLC 5/05 processors.
- (2) Supported only by SLC 5/03 (OS302), and SLC 5/04 (OS401), and SLC 5/05 processors.
- (3) Not supported by SLC 5/01 processors and Fixed controllers.
- (4) Indexed addressing is not allowed when using T, C, R, or M addresses.
- (5) Supported only by L20, L30, and L40 Fixed SLC processors with DC inputs.
- (6) Supported only by SLC 5/02, SLC 5/03, SLC 5/04, and SLC 5/05 processors.
- (7) SLC 5/05 Channel 0 (RS-232 serial port) only.
- (8) For SLC 5/05, control block length = 55 if logical ASCII addressing is used.
- (9) File types F, A, and ST only apply to SLC 5/03 (OS301 or later), SLC 5/04, and SLC 5/05 processors.

**Table D.4 Available Addressing Modes**

<b>Instruction</b>	<b>Description</b>	<b>Instruction Parameter</b>	<b>Valid Addressing Mode(s)</b>	<b>Valid File Types</b>	<b>Immediate Values</b>
MUL	Multiply	source A	direct, indexed direct indirect, indexed indirect	O, I, S, B, T, C, R, N, F, A, ST, M	-32,768 to 32,767 f-min to f-max
		source B	direct, indexed direct indirect, indexed indirect	O, I, S, B, T, C, R, N, F, A, ST, M	-32,768 to 32,767 f-min to f-max
		destination	direct, indexed direct indirect, indexed indirect	O, I, S, B, T, C, R, N, F, A, ST, M	none
MVM	Masked Move	source	direct, indexed direct indirect, indexed indirect	O, I, S, B, T, C, R, N, A, ST, M	none
		source mask	direct, indexed direct indirect, indexed indirect	O, I, S, B, T, C, R, N, A, ST, M	-32,768 to 32,767
		destination	direct, indexed direct indirect, indexed indirect	O, I, S, B, T, C, R, N, A, ST, M	none
NEG	Negate	source	direct, indexed direct indirect, indexed indirect	O, I, S, B, T, C, R, N, F, A, ST, M	none
		destination	direct, indexed direct indirect, indexed indirect	O, I, S, B, T, C, R, N, F, A, ST, M	none
NEQ	Not Equal To	source A	direct, indexed direct indirect, indexed indirect	O, I, S, B, T, C, R, N, F, A, ST, M	none
		source B	direct, indexed direct indirect, indexed indirect	O, I, S, B, T, C, R, N, F, A, ST, M	-32,768 to 32,767 f-min to f-max
NOT	Logical NOT	source	direct, indexed direct indirect, indexed indirect	O, I, S, B, T, C, R, N, A, ST, M	none
		destination	direct, indexed direct indirect, indexed indirect	O, I, S, B, T, C, R, N, A, ST, M	none
OR	Logical OR	source A	direct, indexed direct indirect, indexed indirect	O, I, S, B, T, C, R, N, A, ST, M	-32,768 to 32,767
		source B	direct, indexed direct indirect, indexed indirect	O, I, S, B, T, C, R, N, A, ST, M	-32,768 to 32,767
		destination	direct, indexed direct indirect, indexed indirect	O, I, S, B, T, C, R, N, A, ST, M	none
OSR	One-shot Rising	bit address	direct, indirect	O, I, S, B, T, C, R, N, A, ST	none
OTE	Output Energize	bit address	direct, indirect	O, I, S, B, T, C, R, N, A, ST, M	none
OTL	Output Latch	bit address	direct, indirect	O, I, S, B, T, C, R, N, A, ST, M	none
OTU	Output Unlatch	bit address	direct, indirect	O, I, S, B, T, C, R, N, A, ST, M	none
PID <sup>(1)</sup>	PID	control block	direct	N	none
		process variable	direct, indirect	O, I, B, T, C, R, N, A	none
		control variable	direct, indirect	O, I, B, T, C, R, N, A	none
		control block length			23 always

**Table D.4 Available Addressing Modes (Continued)**

<b>Instruction</b>	<b>Description</b>	<b>Instruction Parameter</b>	<b>Valid Addressing Mode(s)</b>	<b>Valid File Types</b>	<b>Immediate Values</b>
RAD <sup>(2)</sup>	Degrees to Radians	source	direct, indexed direct indirect, indexed indirect	O, I, S, B, T, C, R, N, F, A, ST, M	-32,768 to 32,767 f-min to f-max
		destination	direct, indexed direct indirect, indexed indirect	O, I, S, B, T, C, R, N, F, A, ST, M	none
REF <sup>(1)</sup>	I/O Refresh	channel 0			0=no, 1=yes
		channel 1			0=no, 1=yes
RES	Timer/Counter Reset	structure	direct	T, C, R	none
RET	Return				none
RHC	Read High Speed Clock	destination	direct	N, F	
RMP	Ramp	control	direct	N	
		destination	direct	O, I, S, B, N	
RPC	Read Program Checksum	Proc/Mmod			0=PROC-MEM, 1=MEM-MOD
		destination	direct	N	
RPI <sup>(1)</sup>	Reset Pending Interrupt	slots			double hex word (list of slots)
RTO	Retentive Timer On	timer	direct	T	none
		time base (SLC 5/01)			0.01 only
		time base (SLC 5/02, 5/03, 5/04, 5/05)			0.01 or 1.00
		preset			0 to 32,767
		accum			0 to 32,767
SBR	Subroutine				none
SCL <sup>(3)</sup>	Scale	source	direct, indexed direct indirect, indexed indirect	O, I, S, B, T, C, R, N, A, ST, M	none
		rate	direct, indexed direct indirect, indexed indirect	O, I, S, B, T, C, R, N, A, ST, M	-32,768 to 32,767
		offset	direct, indexed direct indirect, indexed indirect	O, I, S, B, T, C, R, N, A, ST, M	-32,768 to 32,767
		destination	direct, indexed direct indirect, indexed indirect	O, I, S, B, T, C, R, N, A, ST, M	none



**Table D.4 Available Addressing Modes (Continued)**

<b>Instruction</b>	<b>Description</b>	<b>Instruction Parameter</b>	<b>Valid Addressing Mode(s)</b>	<b>Valid File Types</b>	<b>Immediate Values</b>
SCP <sup>(2)</sup>	Scale with Parameters	input	direct, indexed direct indirect, indexed indirect	O, I, S, B, T, C, R, N, F, A, ST, M	none
		input min.	direct, indexed direct indirect, indexed indirect	O, I, S, B, T, C, R, N, F, A, ST, M	-32,768 to 32,767 f-min to f-max
		input max.	direct, indexed direct indirect, indexed indirect	O, I, S, B, T, C, R, N, F, A, ST, M	-32,768 to 32,767 f-min to f-max
		scaled min.	direct, indexed direct indirect, indexed indirect	O, I, S, B, T, C, R, N, F, A, ST, M	-32,768 to 32,767 f-min to f-max
		scaled max.	direct, indexed direct indirect, indexed indirect	O, I, S, B, T, C, R, N, F, A, ST, M	-32,768 to 32,767 f-min to f-max
		scaled output	direct, indexed direct indirect, indexed indirect	O, I, S, B, T, C, R, N, F, A, ST, M	none
SIN <sup>(2)</sup>	Sine	source	direct, indexed direct indirect, indexed indirect	O, I, S, B, T, C, R, N, F, A, ST, M	-32,768 to 32,767 f-min to f-max
		destination	direct, indexed direct indirect, indexed indirect	O, I, S, B, T, C, R, N, F, A, ST, M	none
SOC	Sequencer Compare	file	indexed direct indexed indirect	O, I, S, B, N, A, ST	none
		mask	direct, indexed direct <sup>(4)</sup> indirect, indexed indirect	O, I, S, B, T, C, R, N, A, ST, M	-32,768 to 32,767
		source	direct, indexed direct <sup>(4)</sup> indirect, indexed indirect	O, I, S, B, T, C, R, N, A, ST, M	none
		control	direct	R	none
		length			1 to 255
		position			0 to 255
SQL <sup>(3)</sup>	Sequencer Load	file	indexed direct indexed indirect	O, I, S, B, N, A, ST	none
		source	direct, indexed direct <sup>(4)</sup> indirect, indexed indirect	O, I, S, B, T, C, R, N, A, ST, M	-32,768 to 32,767
		control	direct	R	none
		length			1 to 255
		position			0 to 255

**Table D.4 Available Addressing Modes (Continued)**

Instruction	Description	Instruction Parameter	Valid Addressing Mode(s)	Valid File Types	Immediate Values
SQO	Sequencer Output	file	indexed direct indexed indirect	O, I, S, B, N, A, ST	none
		mask	direct, indexed direct <sup>(4)</sup> indirect, indexed indirect	O, I, S, B, T, C, R, N, A, ST, M	-32,768 to 32,767
		destination	direct, indexed direct <sup>(4)</sup> indirect, indexed indirect	O, I, S, B, T, C, R, N, A, ST, M	none
		control	direct	R	none
		length			1 to 255
		position			0 to 255
SQR <sup>(3)</sup>	Square Root	source	direct, indexed direct indirect, indexed indirect	O, I, S, B, T, C, R, N, F, A, ST, M	-32,768 to 32,767 f-min to f-max
		destination	direct, indexed direct indirect, indexed indirect	O, I, S, B, T, C, R, N, F, A, ST, M	none
STD <sup>(3)</sup>	Selectable Timed Interrupt Disable				none
STE <sup>(3)</sup>	Selectable Timed Interrupt Enable				none
STS <sup>(3)</sup>	Selectable Timed Interrupt Start	file	direct, indexed direct indirect, indexed indirect	O, I, S, B, T, C, R, N, A, ST, M	0, 3 to 255
		time	direct, indexed direct indirect, indexed indirect	O, I, S, B, T, C, R, N, A, ST, M	0 to 255 (SLC 5/02), 0 to 32,767 (SLC 5/03, 5/04, 5/05)
SUB	Subtract	source A	direct, indexed direct indirect, indexed indirect	O, I, S, B, T, C, R, N, F, A, ST, M	-32,768 to 32,767 f-min to f-max
		source B	direct, indexed direct indirect, indexed indirect	O, I, S, B, T, C, R, N, F, A, ST, M	-32,768 to 32,767 f-min to f-max
		destination	direct, indexed direct indirect, indexed indirect	O, I, S, B, T, C, R, N, F, A, ST, M	none
SUS	Suspend	suspend ID			-32,768 to 32,767
SVC <sup>(1)</sup>	Service Communications	channel 0 (SLC 5/03, 5/04, 5/05)			0=no, 1=yes
		channel 1 (SLC 5/03, 5/04, 5/05)			0=no, 1=yes
SWP <sup>(2)</sup>	Swap	source	indexed direct indexed indirect	B, N, A, ST	none
		length			1 to 128: bit, 1 to 128: integer, 1 to 41: string, 1 to 128: ASCII

**Table D.4 Available Addressing Modes (Continued)**

Instruction	Description	Instruction Parameter	Valid Addressing Mode(s)	Valid File Types	Immediate Values
TAN <sup>(2)</sup>	Tangent	source	direct, indexed direct indirect, indexed indirect	O, I, S, B, T, C, R, N, F, A, ST, M	-32,768 to 32,767 f-min to f-max
		destination	direct, indexed direct indirect, indexed indirect	O, I, S, B, T, C, R, N, F, A, ST, M	none
TDF	Compute Time Difference	start	direct	N, F	
		stop	direct	N, F	
		destination	direct	N, F	
TND	Temporary End				none
TOD	Convert to BCD	source (SLC 5/01)	direct	O, I, S, B, T, C, R, N	none
		source (SLC 5/02, 5/03, 5/04, 5/05)	direct, indexed direct indirect, indexed indirect	O, I, S, B, T, C, R, N, A, ST, M	
		destination	direct	O, I, S, B, T, C, R, N, A, ST, M	none
TOF	Timer Off Delay	timer	direct	T	none
		time base (SLC 5/01)			0.01 only
		time base (SLC 5/02, 5/03, 5/04, 5/05)			0.01 or 1.00
		preset			0 to 32,767
		accum			0 to 32,767
TON	Timer on Delay	timer	direct	T	none
		time base (SLC 5/01)			0.01 only
		time base (SLC 5/02, 5/03, 5/04, 5/05)			0.01 or 1.00
		time base (SLC 5/02, 5/03, 5/04, 5/05)			0 to 32,767
		time base (SLC 5/02, 5/03, 5/04, 5/05)			0 to 32,767
		time base (SLC 5/02, 5/03, 5/04, 5/05)			0 to 32,767
XIC	Examine On (Examine if Closed Contact)	source bit	direct, indirect	O, I, S, B, T, C, R, N, A, ST, M	none
XIO	Examine Off (Examine if Open Contact)	source bit	direct, indirect	O, I, S, B, T, C, R, N, A, ST, M	none
XOR	Logical Exclusive OR	address A	direct, indexed direct indirect, indexed indirect	O, I, S, B, T, C, R, N, A, ST, M	-32,768 to 32,767
		address B	direct, indexed direct indirect, indexed indirect	O, I, S, B, T, C, R, N, A, ST, M	-32,768 to 32,767
		destination	direct, indexed direct indirect, indexed indirect	O, I, S, B, T, C, R, N, A, ST, M	none

**Table D.4 Available Addressing Modes (Continued)**

<b>Instruction</b>	<b>Description</b>	<b>Instruction Parameter</b>	<b>Valid Addressing Mode(s)</b>	<b>Valid File Types</b>	<b>Immediate Values</b>
XPY <sup>(2)</sup>	X to the Power of Y	source A	direct, indexed direct indirect, indexed indirect	O, I, S, B, T, C, R, N, F, A, ST, M	-32,768 to 32,767 f-min to f-max
		source B	direct, indexed direct indirect, indexed indirect	O, I, S, B, T, C, R, N, F, A, ST, M	-32,768-32,767 f-min-f-max
		destination	direct, indexed direct indirect, indexed indirect	O, I, S, B, T, C, R, N, F, A, ST, M	none

<sup>(1)</sup> Supported by SLC 5/02, SLC 5/03, SLC 5/04, and SLC 5/05 processors.

<sup>(2)</sup> Supported by SLC 5/03 (OS302), SLC 5/04 (OS401), and SLC 5/05 processors.

<sup>(3)</sup> Not supported by SLC 5/01 processors and Fixed controllers.

<sup>(4)</sup> Indexed addressing is not allowed when using T, C, R, or M addresses.

**TIP**

Message lengths for SLC 5/05 processors are shown in the next table.

Message lengths are based on Ethernet buffer size of 2108 bytes (includes command header and system addressing in addition to actual file data). The local file is the destination file for reads and the source files for writes.

In the following table, byte values are the maximum byte length argument values the compiler should generate to be passed to the MSG instruction and then written to word 11 of the MSG control block by the processor at run time.

**Table D.5 SLC 5/05 Message Lengths**

File Type	485CIF and 500CPU Read/Write		PLC5 Read		PLC5 Write	
	Elements	Bytes	Elements	Bytes	Elements	Bytes
O,I	256	512	256	512	256	512
S	83	166	83	166	83	166
B	256	512	256	512	256	512
T	256	1536	256 (208 when target file type is Timer)	1536 (1248 when target file type is Timer)	208 (201 when using logical ASCII addressing)	1248 (1206 when using logical ASCII addressing)
C	256	1536	256	1536	256	1536
R	256	1536	256	1536	256	1536
N	256	512	256	512	256	512
F	256	1024	256	1024	256	1024
A	256	512 - Treat an ASCII file element here as a whole 16-bit word.	256	512 - Treat an ASCII file element here as 1 byte like PLCs do; compensate by doubling the number of elements that can be read.	256	512 - Treat an ASCII file element here as 1 byte like PLCs do; compensate by doubling the number of elements that can be read.
ST	25 (24 for 500CPU write)	2100 (2016 for 500CPU write)	1		1	
M	256	512	256	512	256	512

**Notes:**

## Data File Organization and Addressing

This chapter discusses the following topics.

- Data file organization and addressing
- Specifying indexed addressing
- Specifying indirect addressing  
(SLC 5/03 OS302, SLC 5/04 OS401, and SLC 5/05 processors)
- Specifying indirect indexed addressing  
(SLC 5/03 OS302, SLC 5/04 OS401, and SLC 5/05 processors)
- Addressing file instructions (using the file indicator #)
- Numeric constants
- M0-M1 files, G files  
(SLC 5/02 and higher processors with specialty I/O modules)

### Understanding File Organization

The processor provides control through the use of a program you create, called a processor file. This file contains other files that break your program down into more manageable parts.

### Processor File Overview

Most of the operations you perform with the programming device involve the processor file and the two components created with it; program files and data files.

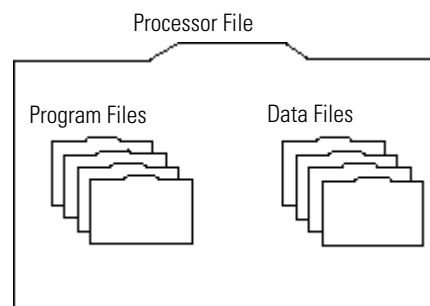

The programming device stores processor files on hard disk (or floppy disk). Monitoring and editing of processor files is done in the workspace of the computer. After you select a file from disk and edit it, you then save the file

hard to disk, replacing the original disk version with the edited version. The hard disk is the recommended location for a processor file.

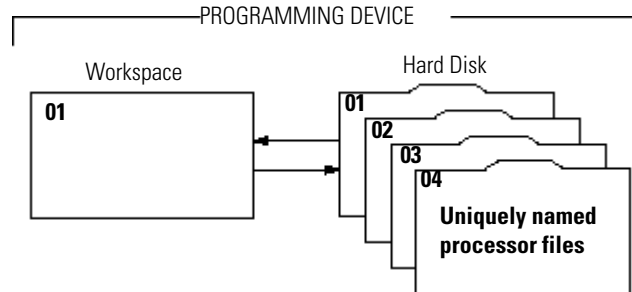

Processor files are created in the offline mode using the programming device. These files are then restored (downloaded), to the processor for online operation.

### *Program Files*

Program files contain controller information, the main ladder program, interrupt subroutines, and any subroutine programs. These files are:

- **System Program** (file 0) - This file contains various system related information and user-programmed information such as processor type, I/O configuration, processor file name, and password.
- **Reserved** (file 1) - This file is reserved.
- **Main Ladder Program** (file 2) - This file contains user-programmed instructions defining how the controller is to operate.
- **Subroutine Ladder Program** (file 3 to 255) - These files are user-created and accessed according to subroutine instructions residing in the main ladder program file.

### *Data Files*

Data files contain the status information associated with external I/O and all other instructions you use in your main and subroutine ladder program files. In addition, these files store information concerning processor operation. You can also use the files to store “recipes” and look-up tables if needed.

These files are organized by the type of data they contain. The data file types are:

- **Output** (file 0) - This file stores the state of the output terminals for the controller.
- **Input** (file 1) - This file stores the status of the input terminals for the controller.



- **Status** (file 2) - This file stores controller operation information. This file is useful for troubleshooting controller and program operation.
- **Bit** (file 3) - This file is used for internal relay logic storage.
- **Timer** (file 4) - This file stores the timer accumulator and preset values and status bits.
- **Counter** (file 5) - This file stores the counter accumulator and preset values and the status bits.
- **Control** (file 6) - This file stores the length, pointer position, and status bits for specific instructions such as shift registers and sequencers.
- **Integer** (file 7) - This file is used to store numeric values or bit information.
- **Floating Point** (file 8) - This file stores single precision non-extended 32-bit numbers. Applies to SLC 5/03 (OS301 and higher), SLC 5/04, and SLC 5/05 processors.
- **String** (user-defined file) - Applies to SLC 5/03 (OS301 and higher), SLC 5/04, and SLC 5/05 processors.
- **ASCII** (user-defined file) - Applies to SLC 5/03 (OS301 and higher), SLC 5/04, and SLC 5/05 processors.

## Addressing Data Files

For the purposes of addressing, each data file type is identified by a letter (identifier) and a file number.

File numbers 0 through 7 are the default files that fixed, SLC 5/01, SLC 5/02, and SLC 5/03 OS300 processors create for you. File number 8 applies only to SLC 5/03 (OS301 and higher), SLC 5/04, and SLC 5/05 processors. If you need additional storage, you can create files by specifying the appropriate identifier and a file number from 9 to 255.

**Table E.1 Data file types, identifiers, and numbers (data files in processor memory)**

<b>File Type</b>	<b>Identifier</b>	<b>File Number</b>
Output	O	0
Input	I	1
Status	S	2
Bit	B	3
Timer	T	4
Counter	C	5
Control	R	6
Integer	N	7
Float	F	8

**User-Defined Files**

<b>File Type</b>	<b>Identifier</b>	<b>File Number</b>
Bit	B	9 to 255
Timer	T	
Counter	C	
Control	R	
Integer	N	
Float	F	
String	St	
ASCII	A	

**TIP**

Floating point, string, and ASCII file types are only available when using SLC 5/03 (OS301 and higher), SLC 5/04, and SLC 5/05 processors.

## Specifying Logical Addresses

You assign logical addresses to instructions from the highest level (element) to the lowest level (bit). Addressing examples are shown in the table below.

To specify the address of a	Use these parameters <sup>(1)</sup>
Word within an integer file	<div style="text-align: right; margin-bottom: 10px;">N 7 : 2</div> <p>File Type File Number File Delimiter Word Number</p>
Word within a structure file (for example, a timer file)	<div style="text-align: right; margin-bottom: 10px;">T 4 : 7 . ACC</div> <p>File Type File Number File Delimiter Structure Number Delimiter Word</p>
Bit within an integer file	<div style="text-align: right; margin-bottom: 10px;">N 7 : 2 / 5</div> <p>File Type File Number File Delimiter Word Number Bit Delimiter Bit Number</p>

<sup>(1)</sup> Some programming devices support short addressing. This allows you to eliminate the file number and file delimiter from addresses. Consult your programming device's user manual for information on addressing capabilities. (For example: N7:2 = N2; T4:12.ACC = T12.ACC; B3:2/12 = B2/12)



Slot	Inputs	Outputs
0	24	16
1	6	6
2	None	8

**Table E.2 Data File 0 - Output Image**

	15	14	13	12	11	10	09	08	07	06	05	04	03	02	01	00	
Slot 0 Outputs (0 to 15)												x					0:0
Slot 1 Outputs (0 to 5)	INVALID																0:1
Slot 2 Outputs (0 to 7)									x								0:2

**Table E.3 Data File 1 - Input Image**

	15	14	13	12	11	10	09	08	07	06	05	04	03	02	01	00	
Slot 0 Inputs (0 to 15)	x											x					l:0
Slot 0 Inputs (16 to 23)	INVALID								x								l:0.1
Slot 1 Inputs (0 to 5)	INVALID											x					l:1

The table on the following page explains the addressing format for outputs and inputs. Note that the format specifies e as the slot number and s as the word number. When you are dealing with file instructions, refer to the element as e.s (slot and word), taken together.

Assign I/O addresses to fixed I/O controllers

**Table E.4 Addressing Format**

Format	Explanation		
<b>O:e.s/b</b> <b>I:e.s/b</b>	<b>0</b>	Output	
	<b>I</b>	Input	
	:	Element delimiter	
		Slot number (decimal)	Fixed I/O controller: 0
	<b>e</b>		Left slot of expansion chassis: 1 Right slot of expansion chassis: 2
	<b>.</b>	Word delimiter. Required only if a word number is necessary as noted below.	
	<b>s</b>	Word number	Required if the number of inputs or outputs exceeds 16 for the slot. Range: 0 to 255 (range accommodates multi-word "specialty cards")
	<b>/</b>	Bit delimiter	
	<b>b</b>	Terminal number	Inputs: 0 to 15 (or 0 to 23, slot 0) Outputs: 0 to 15

**Examples** (applicable to the controller shown on page F-10):

<b>O:0/4</b>	Controller output 4 (slot 0)
<b>O:2/7</b>	Output 7, slot 2 of the expansion chassis
<b>I:1/4</b>	Input 4, slot 1 of the expansion chassis
<b>I:0/15</b>	Controller input 15 (slot 0)
<b>I:0.1/7</b>	Controller input 23 (bit 07, word 1 of slot 0)

Alternate way of addressing I/O terminals 16 and higher: As indicated above, address I:0.1/7 applies to input terminal 23 of slot 0. You can also address this terminal as I:0/23.

**Word addresses:**

<b>O:1</b>	Output word 0, slot 1
<b>I:0</b>	Input word 0, slot 0
<b>I:0.1</b>	Input word 1, slot 0

Default Values: Your programming device will display an address more formally. For example, when you assign the address I:1/4, the programming device will show it as I:1.0/4 (input file, slot 1, word 0, terminal 4).

*I/O Addressing for a Modular Controller*

With modular controllers, slot number 0 is reserved for the processor module (CPU). Slot 0 is invalid as an I/O slot.

The figure below shows a modular controller configuration consisting of a 7-slot chassis interconnected with a 10-slot chassis. Slot 0 contains the CPU.



## Specifying Indexed Addresses

The indexed address symbol is the # character. Place the # character immediately before the file-type identifier in a logical address. You can use more than one indexed address in your ladder program.

Enter the offset value in word 24 of the status file (S:24). All indexed instructions use the same word S:24 to store the offset value. The processor starts operation at the base address plus the offset. You can manipulate the offset value in your ladder logic before each indexed address operation.

When you specify indexed addresses, follow these guidelines.

- Make sure the index value (positive or negative) does not cause the indexed address to exceed the file type boundary.
- When an instruction uses more than two indexed addresses, the processor uses the same index value for each indexed address.
- Set the index word to the offset value you want immediately before enabling an instruction that uses an indexed address.

### ATTENTION



Instructions with a # sign in an address manipulate the offset value stored at S:24. Make sure you monitor or load the offset value you want prior to using an indexed address. Otherwise unpredictable machine operation could occur with possible damage to equipment and/or injury to personnel.

### Example of Indexed Addressing

The following Masked Move (MVM) example uses an indexed address in the source and destination addresses. If the offset value is 10 (stored in S:24), the processor manipulates the data stored at the base address plus the offset.

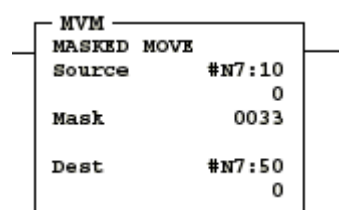



In this example, the processor uses the following addresses:

**Table E.5 Addresses used for Indexing**

<b>Value:</b>	<b>Base Address:</b>	<b>Offset Value in S:24</b>	<b>Offset Address:</b>
Source	N7:10	10	N7:20
Destination	N7:50	10	N7:60

*SLC 5/03 (OS301 and higher), SLC 5/04, and SLC 5/05 processors:* If the indexed address is a floating point (F8:) data file, then the index offset value in S:24 is the offset in elements. If the indexed address is a string (ST) data file, then the index offset value in S:24 is the offset in sub-elements. This limits string element boundaries from being crossed.

Note that file instructions (SQO, COP, LFL for example) overwrite S:24 when they execute. For this reason, you must insure that the index register is loaded with the intended value prior to the execution of an indexed instruction that follows a file instruction.

### *Creating Data for Indexed Addresses*

Data tables are not expanded automatically to accommodate indexed addresses. You must create this data with the memory map function. In the example on the previous page, data words N7:3 through N7:12 and N11:6 through N11:15 must be allocated. Failure to do so will result in an unintended overwrite condition or a major fault.

### *Crossing File Boundaries*

An offset value may extend operation to an address outside the data file boundary. You can either allow or disallow crossing file boundaries. If you choose to disallow crossing file boundaries, a runtime error occurs if you use an offset value which would result in crossing a file boundary.

*SLC 5/02 processors:* You are allowed to select crossing file boundaries only if no indexed addresses exist in the O: (output), I: (input), or S: (status) files. This selection is made at the time you save your program. The file order from start to finish is:

- O0:, I1:, S2:, B3:, T4:, C5:, R6:, N7:, x9:, x10: . . .
- x9: and x10: . . . are application-specific files where x can be of types B, T, C, R, N.

*SLC 5/03 (OS301 and higher) SLC 5/04, and SLC 5/05 processors:* When an indexed string data file is specified, indexed addressing is not allowed to cross a string element boundary. A run-time error will occur if you use an offset value that results in crossing a string element boundary.

**TIP**

If a file is constant protected, indexing across file boundaries is not allowed.

*Example*

The figure below indicates the maximum offset for word address #T4:3.ACC when allowing and disallowing crossing file boundaries.

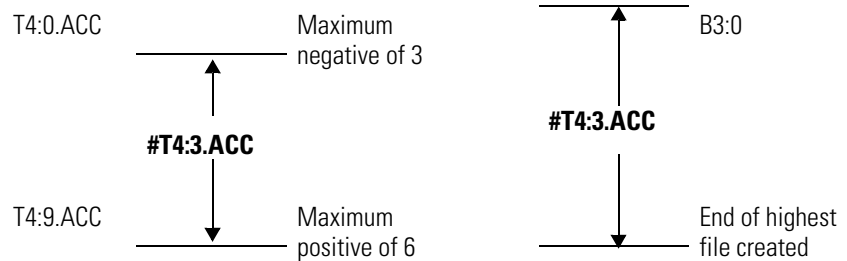

**Crossing file boundaries disallowed**

**Crossing file boundaries allowed**

**Crossing file boundaries disallowed:** In the example above, the highest numbered element in the timer data file is T4:9. This means that #T4:3.ACC can have a maximum negative offset of -3 and a maximum positive offset of 6.

**Crossing file boundaries allowed:** The maximum negative offset extends to the beginning of data file 3. The maximum positive offset extends to the end of the highest numbered file created.

## Monitoring Indexed Addresses

The offset address value is not displayed when you monitor an indexed address. For example, the value at N7:2 appears when you monitor indexed address #N7:2.

### Example

If your application requires you to monitor indexed data, we recommend that you use a MOV instruction to store the value.

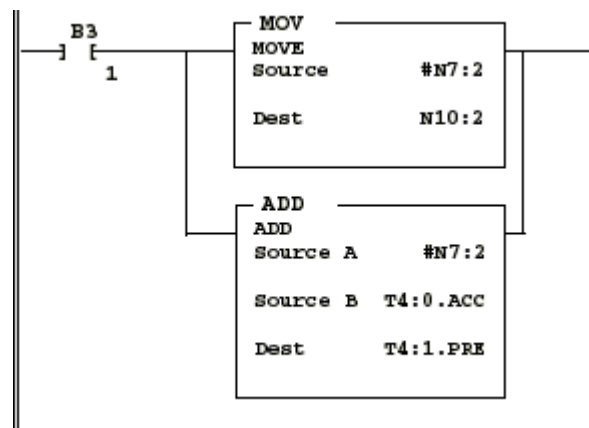

N10:2 will contain the data value that was added to T4:0.ACC.

### File Instructions

The # symbol is also required for addresses in file instructions. The indexed addresses used in these file instructions also make use of word S:24 to store an offset value upon file instruction completion. Refer to the next page for a list of file instructions that use the # symbol for addressing.

#### ATTENTION



File instructions manipulate the offset value stored in word S:24. Make sure that you load the correct offset value in S:24 prior to using an indexed address that follows a file instruction. Otherwise, unpredictable operation could occur, resulting in possible personal injury and/or damage to equipment.

### *Effects of Program Interrupts on Index Register S:24*

When normal program operation is interrupted by the user error handler, an STI, or an I/O interrupt, the content of index register S:24 is saved; then, when normal program operation is resumed, the content of index register S:24 is restored. This means that if you alter the value in S:24 in these interrupt subroutines, the system will overwrite your alteration with the original value contained on subroutine entry.

## **Specifying an Indirect Address**

Indirect addressing allows you to write less complex ladder logic programs and saves you memory space. You have the option of using word-level and bit-level indirect addresses when using an SLC 5/03 (OS302), SLC 5/04 (OS401), and SLC 5/05 processors. Indirect bit addresses are based on the form of the indirect address and the type of bit instruction.

Use indirect addressing for applications such as indexing sequential batch files in a multiple batch operation. For example, at completion of each operation, let a counter accumulated value call out the next batch file, such as: N10, N11, N12,...N[C5:0.ACC].

When you specify indirect addresses, follow these guidelines.

- You can indirectly address:
  - file number.
  - word number (element + sub-element).
  - bit number (in a binary file).
- The substitute address must be any address specified to the word level.
- Enter the substitute address in brackets [ ].

*Examples***Table E.6 Valid Addresses**

<b>Valid Address</b>	<b>Variable</b>	<b>Explanation</b>
N7:[C5:7.ACC]	Word number	The word number is the accumulated value of counter 7 in file 5.
B3/[I:0.17]	Bit number	The bit number is stored in input word 17.
N[N7:0]:[N9:1]	File and word number	The file number is stored in integer address N7:0 and the word number in integer address N9:1.
St10:[N7:0].1	Element number	The element number is stored in N7:0.
I:[N7:0].1/1	Slot number	The slot number is stored in N7:0.

*Creating Data for Indirect Addresses*

Data tables are not expanded automatically to accommodate indirect addresses. You must create this data with your programming software.

*Crossing File Boundaries*

Crossing file boundaries is not allowed. A runtime error occurs if you use an offset value which would result in crossing a file boundary.

*Monitoring Indirect Addresses*

An asterisk is displayed at all times when monitoring an indirect address.

**Addressing File Instructions - Using the File Indicator (#)**

File instructions employ user-created files. These files are addressed with the # sign. They store an offset value in word S:24, just as with indexed addressing discussed in the last section.

<b>COP</b>	Copy File	<b>LFL</b>	(LIFO Load)*
<b>FLL</b>	Fill File	<b>LFU</b>	(LIFO Unload)*
<b>BSL</b>	Bit Shift Left	<b>SQO</b>	Sequencer Output
<b>BSR</b>	Bit Shift Right	<b>SQC</b>	Sequencer Compare
<b>FFL</b>	(FIFO Load)*	<b>SQL</b>	Sequencer Load*
<b>FFU</b>	(FIFO Unload)*		

\* Available in the SLC 5/02 and higher processors.

**ATTENTION**



If you are using file instructions and also indexed addressing, make sure that you monitor and/or load the correct offset value prior to using an indexed address. Otherwise, unpredictable operation could occur, resulting in possible personal injury and/or damage to equipment.

The following paragraphs explain user-created files as they apply to Bit Shift instructions, Sequencer instructions, Copy File, and Fill File instructions.

*Bit Shift Instructions*

The following figure shows a user-defined file within bit data file 3. For this particular user-defined file, you would enter the following parameters when programming the instruction:

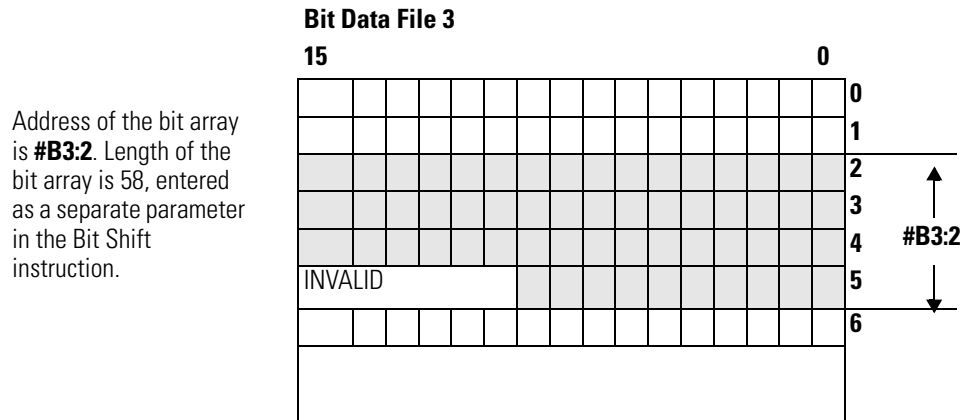

- **#B3:2** - The address of the bit array. This defines the starting bit as bit 0 in element 2, data file 3.
- **58** - This is the length of the bit array, 58 bits. Note that the bits “left over” in element 5 are unusable.

You can program as many bit arrays as you like in a bit file. Be careful that they do not overlap.







When *entering* values into an instruction or data table element, you can specify the radix of your entry using the appropriate suffix. The radices that can be used to enter data into an instruction or data table element are:

- integer (D).
- binary (B).
- hexadecimal (H).
- octal (O).

Numeric constants are used in place of data file elements. They cannot be manipulated by the user program. You must enter the offline program editor to change the value of a constant.

## **M0 and M1 Data Files - Specialty I/O Modules**

M0 and M1 files are data files that reside in specialty I/O modules only. There is no image for these files in the processor memory. The application of these files depends on the function of the particular specialty I/O module. For some modules, the M0 file is regarded as a module output file and the M1 file is regarded as a module input file. In any case, both M0 and M1 files are considered read/write files by the SLC 5/02 and higher processors.

M0 and M1 files can be addressed in your ladder program and they can also be acted upon by the specialty I/O module-independent of the processor scan. It is important that you keep the following in mind in creating and applying your ladder logic.

### **TIP**

During the processor scan, M0 and M1 data can be changed by the processor according to ladder diagram instructions addressing the M0 and M1 files. During the same scan, the specialty I/O module can change M0 and M1 data, independent of the rung logic applied during the scan.

## Addressing M0-M1 Files

The addressing format for M0 and M1 files is below:

$$Mf:e.s/b$$

Where

**M** = module

**f** = file type (0 or 1)

**e** = slot (1 to 30)

**s** = word (0 to max. supplied by module)

**b** = bit (0 to 15)

## Restrictions on Using M0 and M1 Data File Addresses

M0 and M1 data file addresses can be used in all instructions except the OSR instruction and the instruction parameters noted below.

**Table E.7 Instruction parameters not available for Use with M0 and M1 data File Addresses**

Instruction	Parameter (uses file indicator #)
BSL, BSR	File (bit array)
SQO, SQC, SQL	File (sequencer file)
LFL, LFU	LIFO (stack)
FFL, FFU	FIFO (stack)

## Monitoring Bit Addresses

### *SLC 5/02 and Higher Processors with M0 and M1 Monitoring Disabled*

When you monitor a ladder program in the run or test mode, the following bit instructions, addressed to an M0 or M1 file, are indicated as false regardless of their actual true/false logical state.

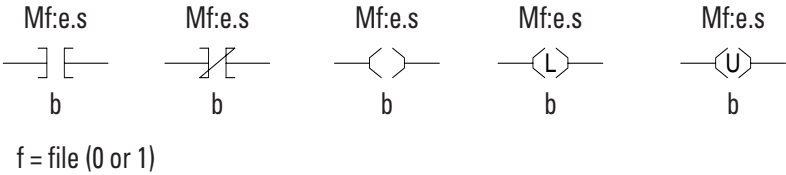

When you are monitoring the ladder program in the run or test mode, the programming terminal does not show these instructions as being true when the processor evaluates them as true.

*SLC 5/03 and Higher Processors*

The SLC 5/03 and higher processors allow you to monitor the actual state of each addressed M0/M1 address (or data table). The highlighting appears normal when compared to the other processor data file. The SLC 5/03's performance is degraded to the degree of M0/M1 referenced screen data. For example, if your screen has only one M0/M1 element, degradation is minimal. If your screen has 69 M0/M1 elements, degradation is significant.

If you need to show the state of the M0 or M1 addressed bit, you can transfer the state to an internal processor bit. This is illustrated in the following figure, where an internal processor bit is used to indicate the true/false state of a rung.

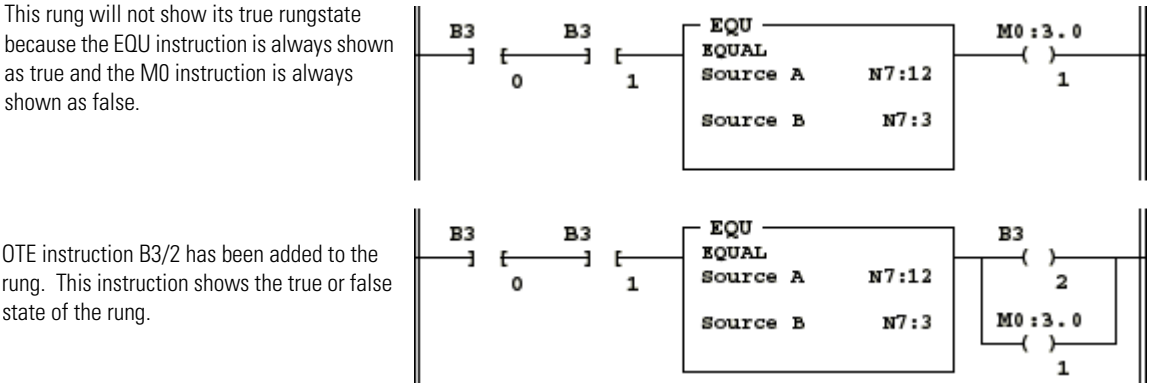

**Transferring Data Between Processor Files and M0 or M1 Files**

As pointed out earlier, the processor does not contain an image of the M0 or M1 file. As a result, you must edit and monitor M0 and M1 file data via instructions in your ladder program. For example, you can copy a block of data from a processor data file to an M0 or M1 data file or vice versa using the COP instruction in your ladder program.

The COP instructions below copy data from a processor bit file and integer file to an M0 file. Suppose the data is configuration information affecting the operation of the specialty I/O module.

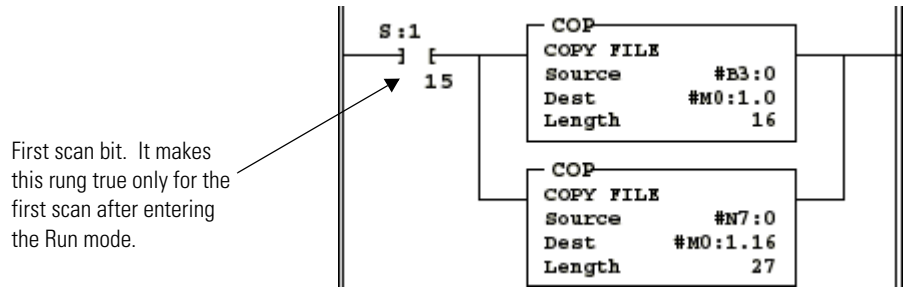

The COP instruction that follows copies data form an M1 data file to an integer file. This technique is used to monitor the contents of an M0 or M1 data file indirectly, in a processor data file.

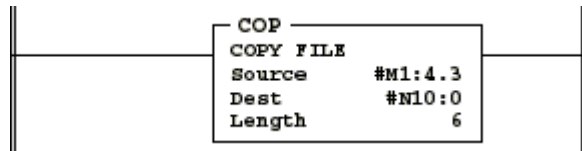

### Access Time

During the program scan, the processor must access the specialty I/O card to read/write M0 or M1 data. This access time must be added to the execution time of each instruction referencing M0 or M1 data.

### Minimizing the Scan Time

You can keep the processor scan time to a minimum by economizing on the use of instructions addressing the M0 or M1 files. For example, XIC instruction M0:2.1/1 is used in rungs 1 and 2 of the figure below, adding approximately 2 ms to the scan time if you are using an SLC 5/02, Series B processor.

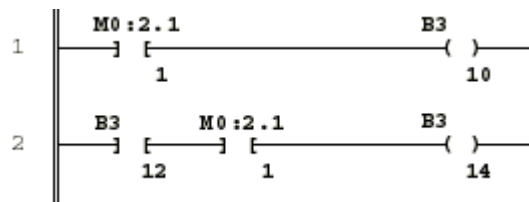

XIC instructions in rungs 1 and 2 are addressed to the M0 data file. Each of these instructions adds approximately 1 ms to the scan time (SLC 5/02, Series B processor).



## Capturing M0-M1 File Data

The first two ladder diagrams in the last section illustrate a technique allowing you to capture and use M0 or M1 data as it exists at a particular time. In the first figure, bit M0:2.1/1 could change state between rungs 1 and 2. This could interfere with the logic applied in rung 2. The second figure avoids the problem. If rung 1 is true, bit B3/10 captures this information and places it in rung 2.

In the second example of the last section, a COP instruction is used to monitor the contents of an M1 file. When the instruction goes true, the 6 words of data in file #M1:4.3 is captured as it exists at that time and placed in file #N10.0.

## Specialty I/O Modules with Retentive Memory

Certain specialty I/O modules retain the status of M0-M1 data after power is removed. See your specialty I/O module user's manual. This means that an OTE instruction having an M0 or M1 address remains on if it is on when power is removed. A "hold-in" rung as shown below will not function as it would if the OTE instruction were non-retentive on power loss. If the rung is true at the time power is removed, the OTE instruction latches instead of dropping out; when power is again applied, the rung is evaluated as true instead of false.

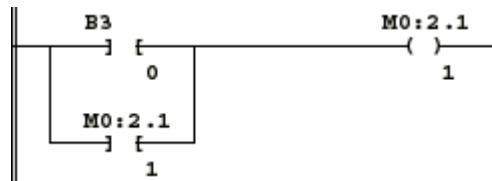

### ATTENTION



When used with a specialty I/O module having retentive outputs, this rung can cause unexpected start-up on powerup.

You can achieve non-retentive operation by unlatching the retentive output with the first pass bit at powerup.

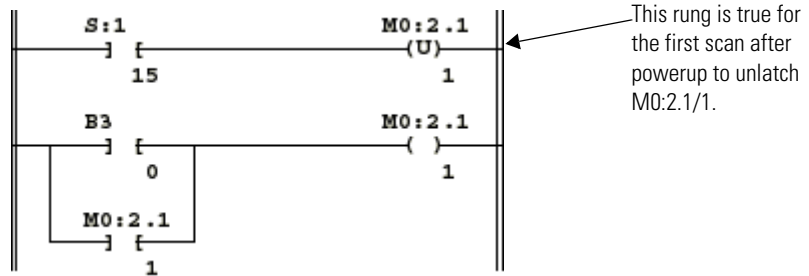

## G Data Files - Specialty I/O Modules

Some specialty I/O modules use G (confiGuration) files (indicated in the specific specialty I/O module user's manual). These files can be thought of as the software equivalent of DIP switches.

The content of G files is accessed and edited offline under the I/O Configuration function. You cannot access G files under the Monitor File function. Data you enter into the G file is passed on to the specialty I/O module when you download the processor file and enter the REM Run or any one of the REM Test modes.

### Editing G File Data

Data in the G file must be edited according to your application and the requirements of the specialty I/O module. You edit the data offline under the I/O configuration function only. With the decimal and hex/bcd formats, you edit data at the word level.

- G1:1 = 234 (decimal format)  
G1:1 = 00EA (hex/bcd format)

#### TIP

Word 0 of the G file is configured automatically by the processor according to the particular specialty I/O module. Word 0 cannot be edited.

**Notes:**



## Number Systems

This appendix:

- covers binary and hexadecimal numbers.
- explains the use of a hex mask to filter data in certain programming instructions.

### Binary Numbers

The processor memory stores 16-bit binary numbers. As indicated in the following figure, each position in the number has a decimal value, beginning at the right with  $2^0$  and ending at the left with  $2^{15}$ .

Each position can be 0 or 1 in the processor memory. A 0 indicates a value of 0; a 1 indicates the decimal value of the position. The equivalent decimal value of the binary number is the sum of the position values.

### Positive Decimal Values

The far left position will always be 0 for positive values. As indicated in the figure, this limits the maximum positive decimal value to 32767. All positions are 1 except the far left position.

Other examples:

$$\begin{aligned} 0000\ 1001\ 0000\ 1110 &= 2^{11}+2^8+2^3+2^2+2^1 \\ &= 2048+256+8+4+2 = 2318 \\ 0010\ 0011\ 0010\ 1000 &= 2^{13}+2^9+2^8+2^5+2^3 \\ &= 8192+512+256+32+8 \\ &= 9000 \end{aligned}$$

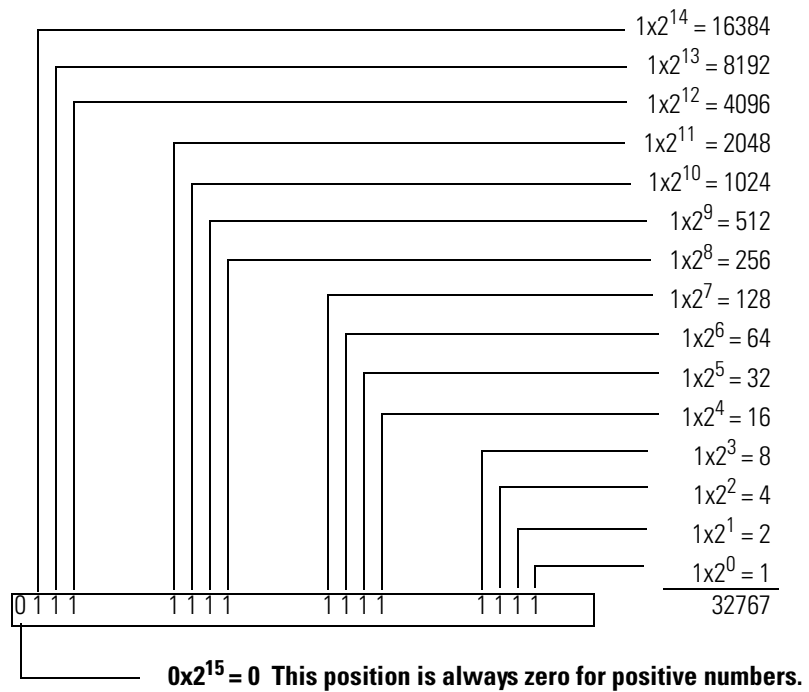

### Negative Decimal Values

The 2s complement notation is used. The far left position is always 1 for negative values. The equivalent decimal value of the binary number is obtained by subtracting the value of the far left position, 32768, from the sum of the values of the other positions. In the following figure, the value is  $32767 - 32768 = -1$ . All positions are 1.

Another example:

$$1111\ 1000\ 0010\ 0011 =$$

$$(2^{14} + 2^{13} + 2^{12} + 2^{11} + 2^5 + 2^1 + 2^0) - 215 =$$

$$(16384 + 8192 + 4096 + 2048 + 32 + 2 + 1) - 32768 =$$

$$30755 - 32768 = -2013.$$

An often easier way to calculate a value is to locate the last 1 in the string of 1s beginning at the left, and subtract its value from the total value of positions to the right of that position. For example,

$$1111\ 1111\ 0001\ 1010 = (24 + 23 + 21) - 28 = (16 + 8 + 2) - 256 = -230.$$

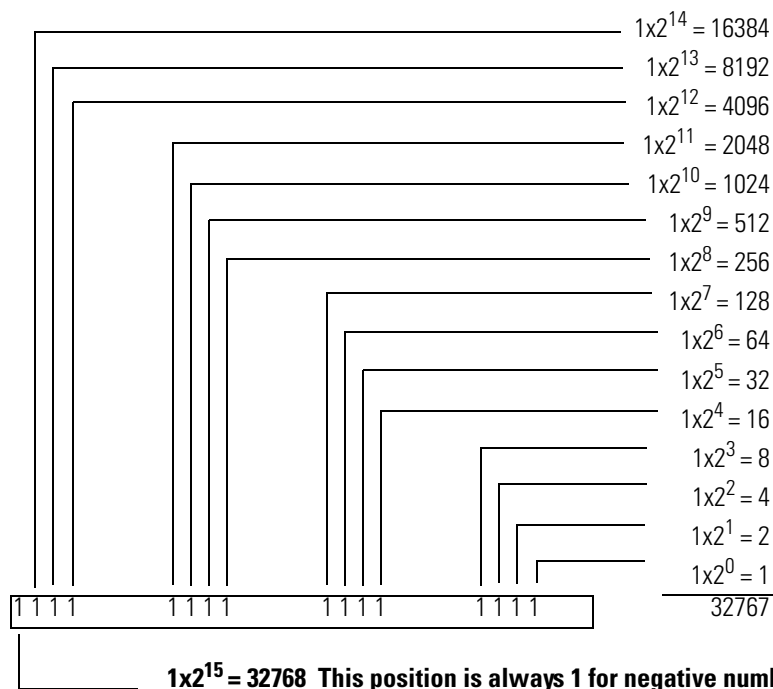

## Hexadecimal Numbers

Hexadecimal numbers use single characters with equivalent decimal values ranging from 0 to 15.

HEX	0	1	2	3	4	5	6	7	8	9	A	B	C	D	E	F
Decimal	0	1	2	3	4	5	6	7	8	9	10	11	12	13	14	15

The position values of hexadecimal numbers are powers of 16, beginning with  $16^0$  at the right:

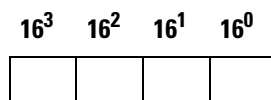

*Example*

Hexadecimal number 218A has a decimal equivalent value of 8586.

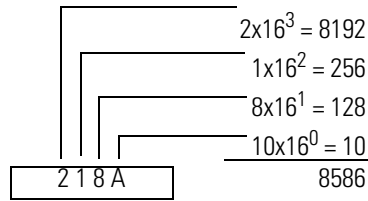

Hexadecimal and binary numbers have the following equivalence.

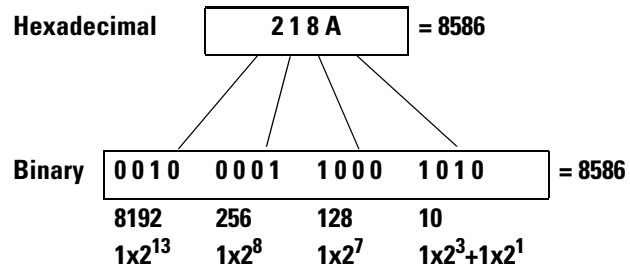

*Example*

Decimal number -8586 in equivalent binary and hexadecimal form.

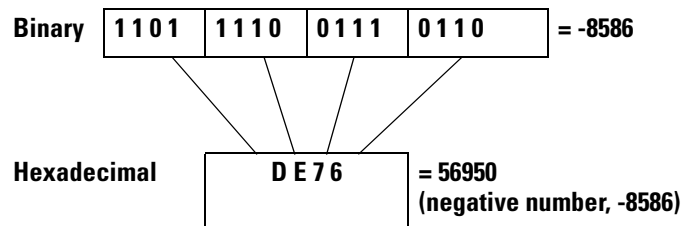

Hexadecimal number DE76 =  $13 \times 16^3 + 14 \times 16^2 + 7 \times 16^1 + 6 \times 16^0 = 56950$ . We know this is a negative number because it exceeds the maximum positive value of 32767. To calculate its value, subtract  $16^4$  (the next higher power of 16) from 56950:  $56950 - 65536 = -8586$ .

## Hex Mask

This is a 4-character code, entered as a parameter in SQO, SQC, and other instructions to exclude selected bits of a word from being operated on by the instruction. The hexadecimal values are used in their binary equivalent form, as indicated in the figure below. The figure also shows an example of a hexadecimal code and the corresponding mask word.

Hex Value	Binary Value
0	0000
1	0001
2	0010
3	0011
4	0100
5	0101
6	0110
7	0111
8	1000
9	1001
A	1010
B	1011
C	1100
D	1101
E	1110
F	1111

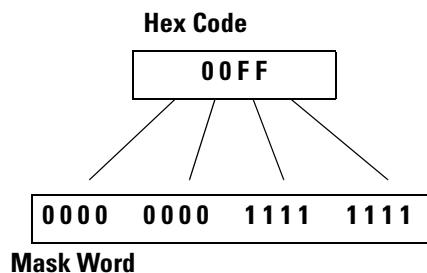

Bits of the mask word that are set (1) will pass data from a source to a destination. Reset bits (0) will not. In the example below, data in bits 0-7 of the source word is passed to the destination word. Data in bits 8-15 of the source word is not passed to the destination word.

<b>Source Word</b>	1110 1001 1100 1010
<b>Mask Word</b>	0000 0000 1111 1111
<b>Destination Word</b> (all bits 0 initially)	0000 0000 1100 1010



## Application Example Programs

This appendix is designed to illustrate various instructions described previously in this manual. Application example programs include:

- paper drilling machine using most of the instructions.
- time driven sequencer using TON and SQO instructions.
- event driven sequencer using SQC and SQO instructions.
- on/off circuit using basic, program flow, and application specific instructions.
- interfacing with enhanced bar code decoders over DH-485.

Because of the variety of uses for this information, the user of and those responsible for applying this information must satisfy themselves as to the acceptability of each application and use of the program. In no event will Rockwell Automation be responsible or liable for indirect or consequential damages resulting from the use of application of this information.

The illustrations, chart, and examples shown in this appendix are intended solely to illustrate the principles of the controller and some of the methods used to apply them. Particularly because of the many requirements associated with any particular installation, Rockwell Automation cannot assume responsibility or liability for actual use based upon the illustrative uses and applications.

### Paper Drilling Machine Application Example

For a detailed explanation of:

- XIC, XIO, OTE, RES, OTU, OTL, and OSR instructions, see Chapter 2.
- EQU and GEQ instructions, see Chapter 3.
- CLR, ADD, and SUB instructions, see Chapter 4.
- MOV and FRD instructions, see Chapter 5.
- JSR and RET instructions, see Chapter 6.
- INT instruction, see Chapter 11.
- SQO instruction, see Chapter 7.

This machine can drill 3 different hole patterns into bound manuals. The program tracks drill wear and signals the operator that the bit needs replacement. The machine shuts down if the signal is ignored by the operator.

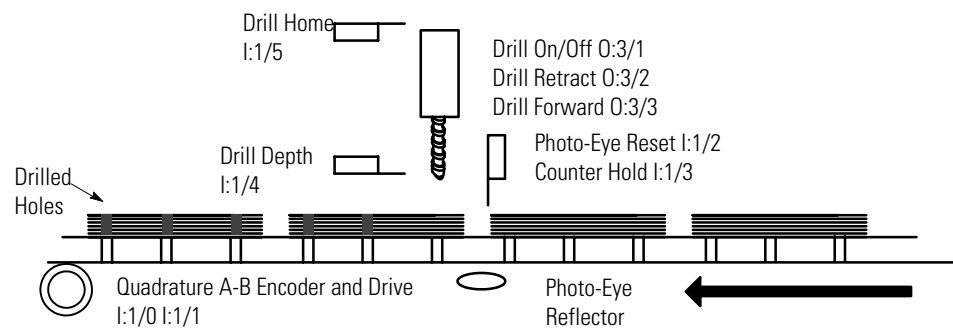
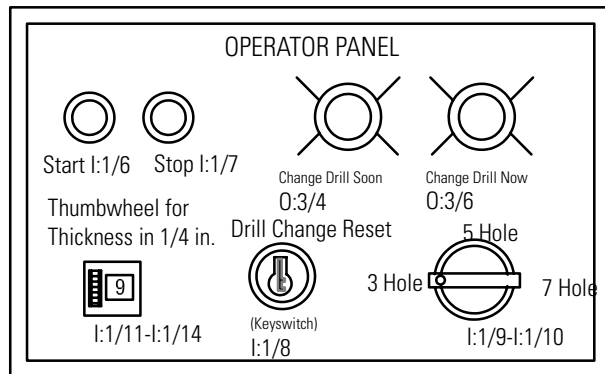

Conveyor Enable wired in series to the Drive O:3/5  
 Conveyor Drive Start/Stop wired in series to the Drive O:3/0



# Paper Drilling Machine Operation Overview

Undrilled books are placed onto a conveyor taking them to a single spindle drill. Each book moves down the conveyor until it reaches the first drilling position. The conveyor stops moving and the drill lowers and drills the first hole. The drill then retracts and the conveyor moves the same book to the second drilling position. The drilling process is repeated until there are the desired holes per book.

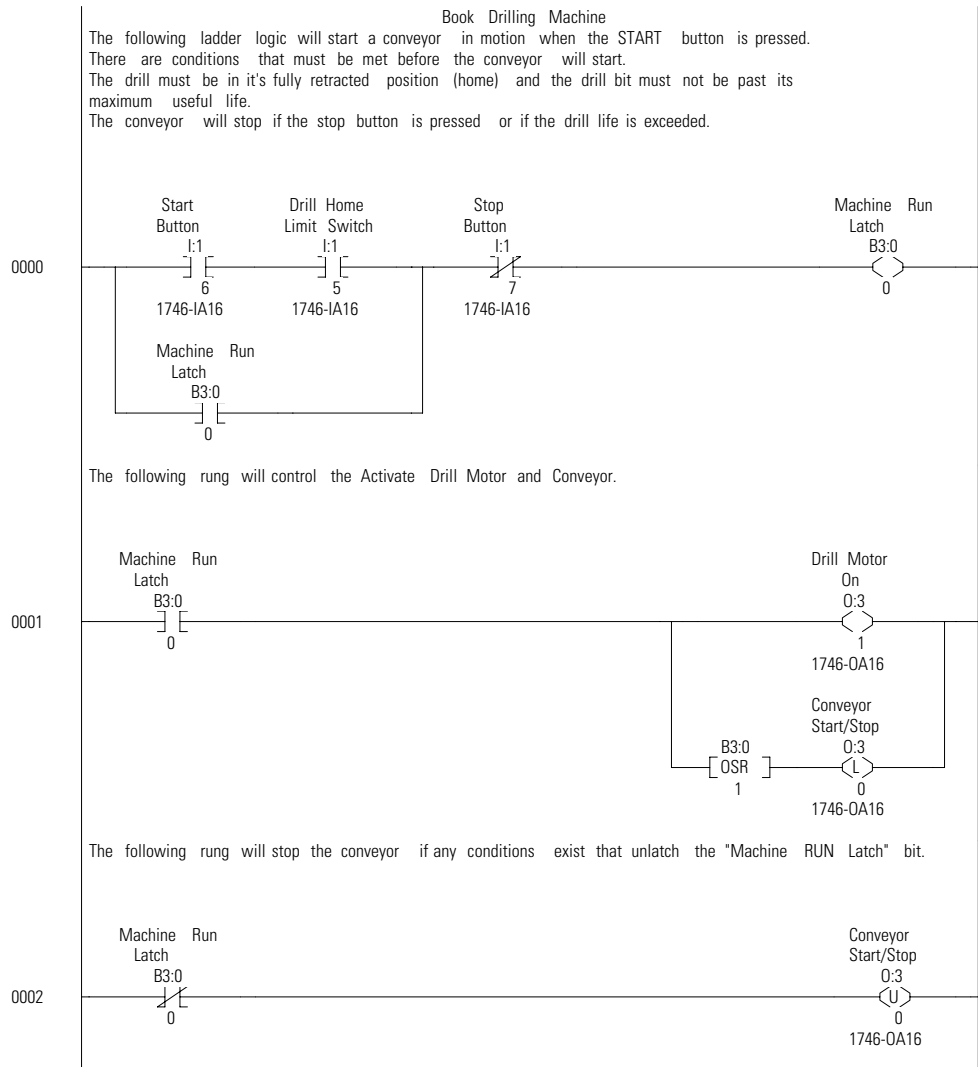

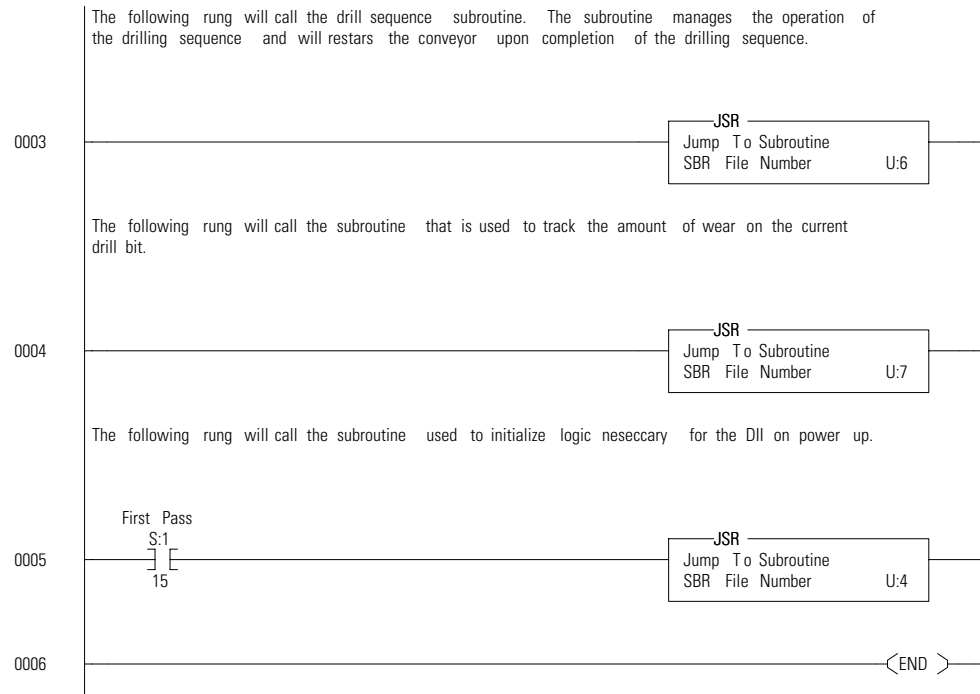

## Drill Mechanism Operation

When the operator presses the start button, the drill motor turns on. After the book is in the first drilling position, the conveyor subroutine sets a drill sequence start bit, and the drill moves toward the book. When the drill has drilled through the book, the drill body hits a limit switch and causes the drill to retract up out of the book. When the drill body is fully retracted, the drill body hits another limit switch indicating that it is in the home position. Hitting the second limit switch unlatches the drill sequence start bit and causes the conveyor to move the book to the next drilling position.

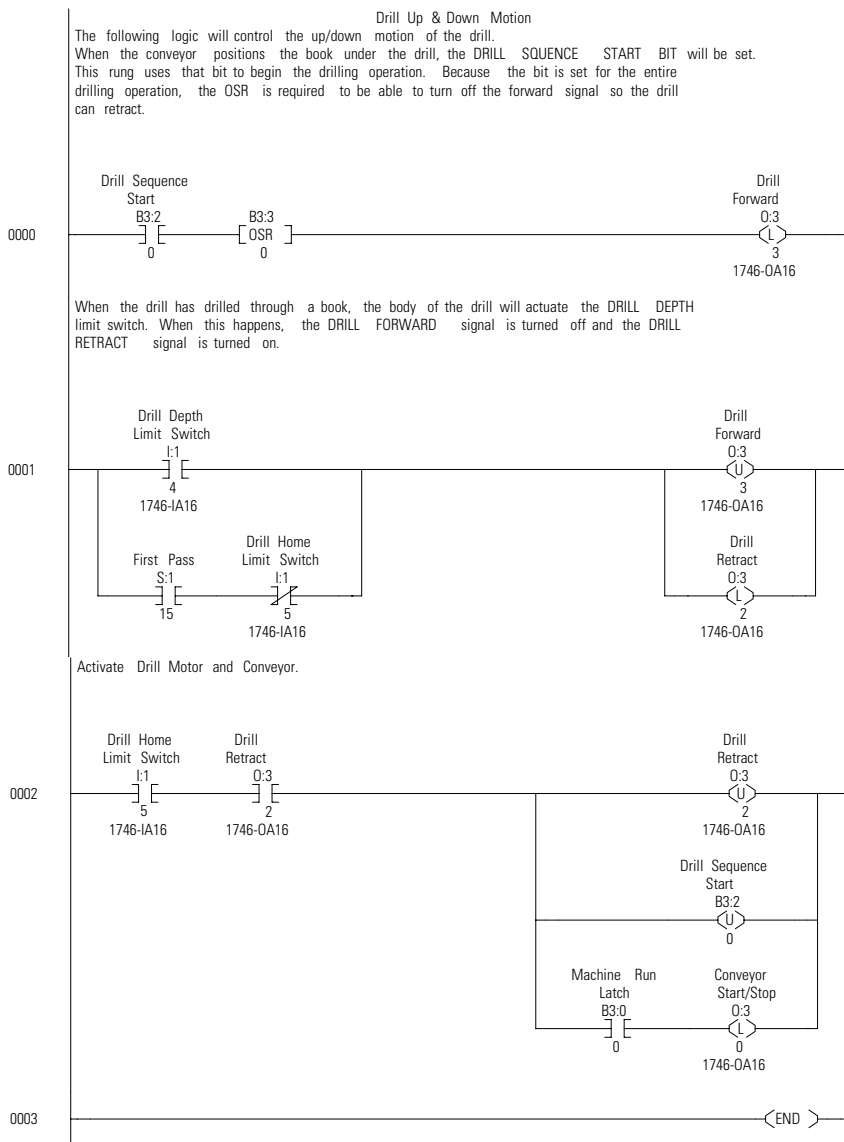

## Conveyor Operation

When the start button is pressed, the conveyor moves the books forward. As the first book moves close to the drill, the book trips a photo-eye sensor. This tells the machine where the leading edge of the book is. Based on the position of the selector switch, the conveyor moves the book until it reaches the first drilling position. The drill sequence start bit is set and the first hole is drilled. The drill sequence start bit is now unlatched and the conveyor moves the same book to the second drilling position. The drilling process is then repeated until there are the desired holes per book. The machine then looks for another book to break the photo-eye beam and the process is repeated. The operator can change the number of drilled holes by changing the selector switch.

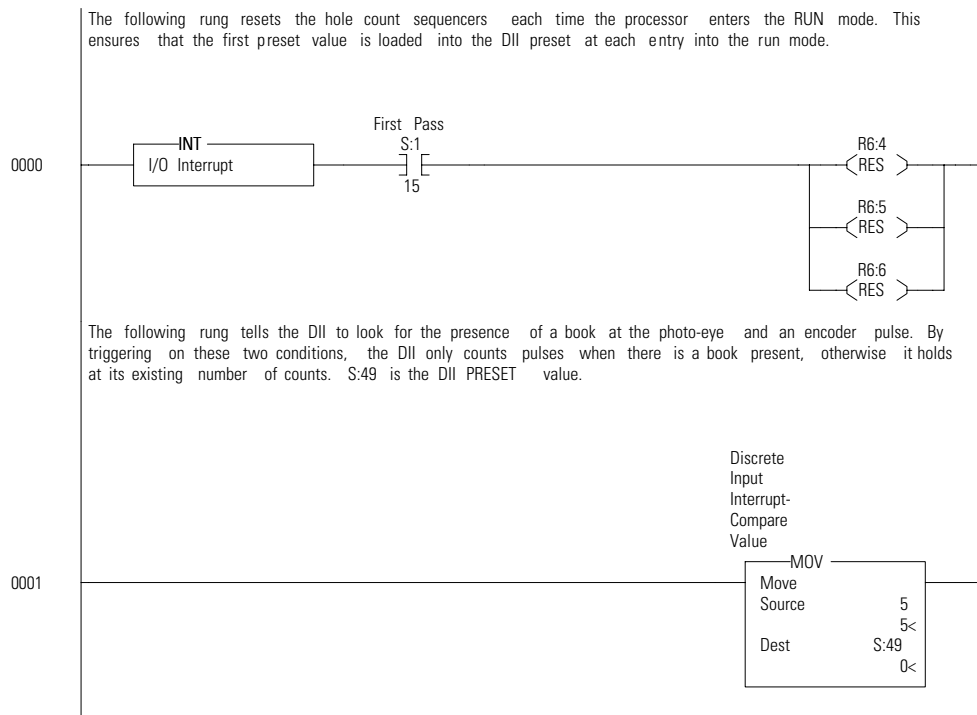

The following rung will keep track of the hole number that is being drilled and loads the next correct DII preset based on the hole count. This rung is only active when the "HOLE SELECTOR" switch is in the "3-HOLE" position. The sequencer uses step 0 as a null step upon reset. It uses the last step as a "go forever" in anticipation of the "end of manual". Movin g a 0 i n t o S :49 tells the D I I to trigger an interrupt when the trailing edge of the current book is detected.

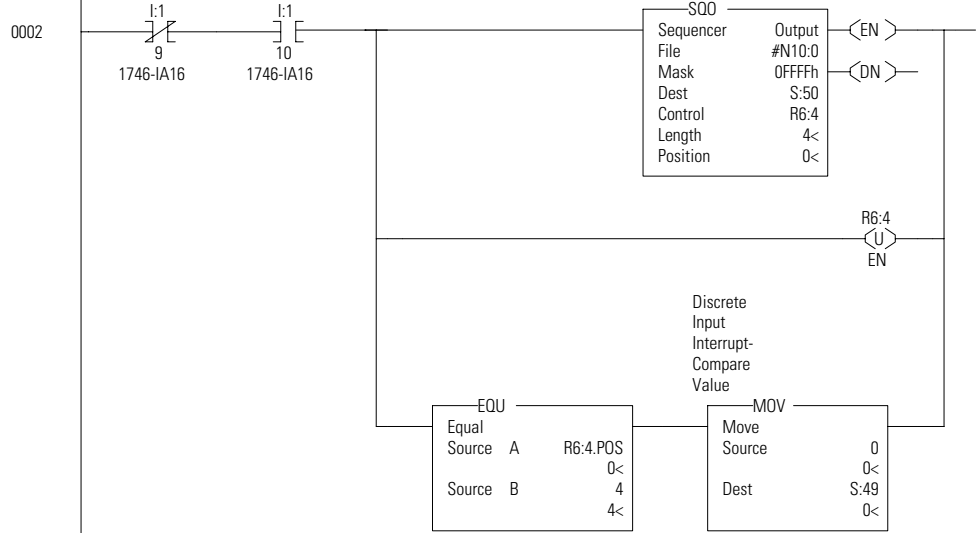

The following rung is identical to the previous rung except that it is only active when the "HOLE SELECTOR" switch is in the "5-HOLE" position.

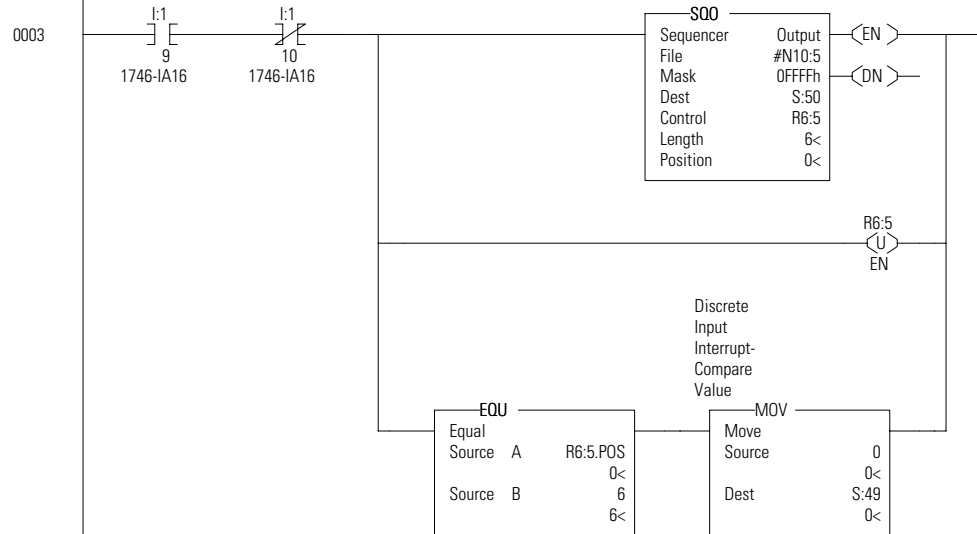

The following rung is identical to the previous two rungs except that it is only active when the "HOLE SELECTOR" switch is in the "7-HOLE" position.

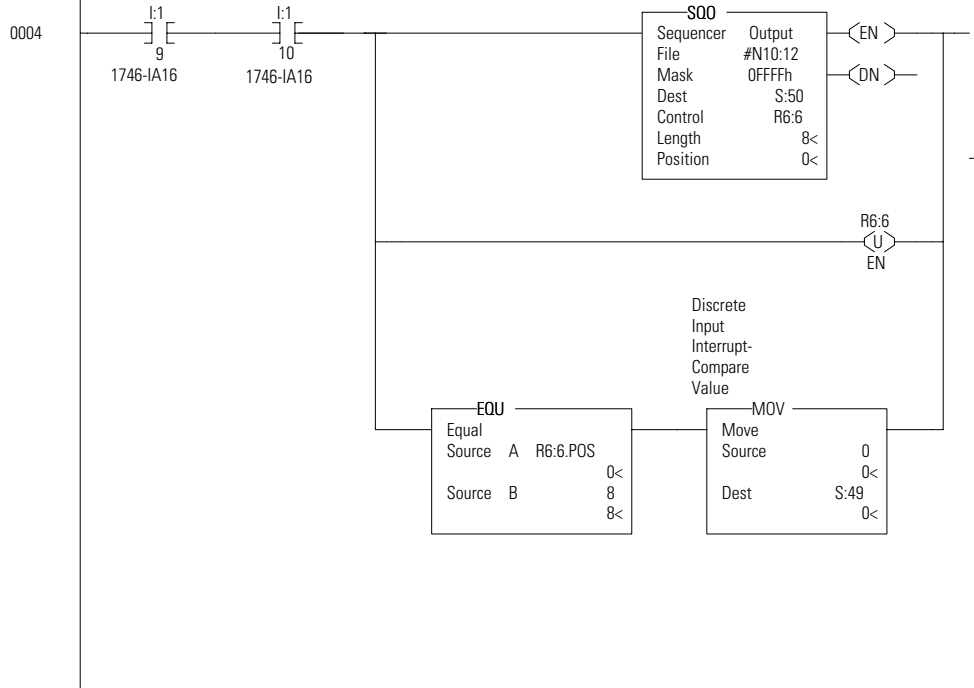

If the processor is in this subroutine either for initialization or due to sensing the trailing edge of a manual, just return and skip the logic that stops the conveyor and starts the drill sequence.

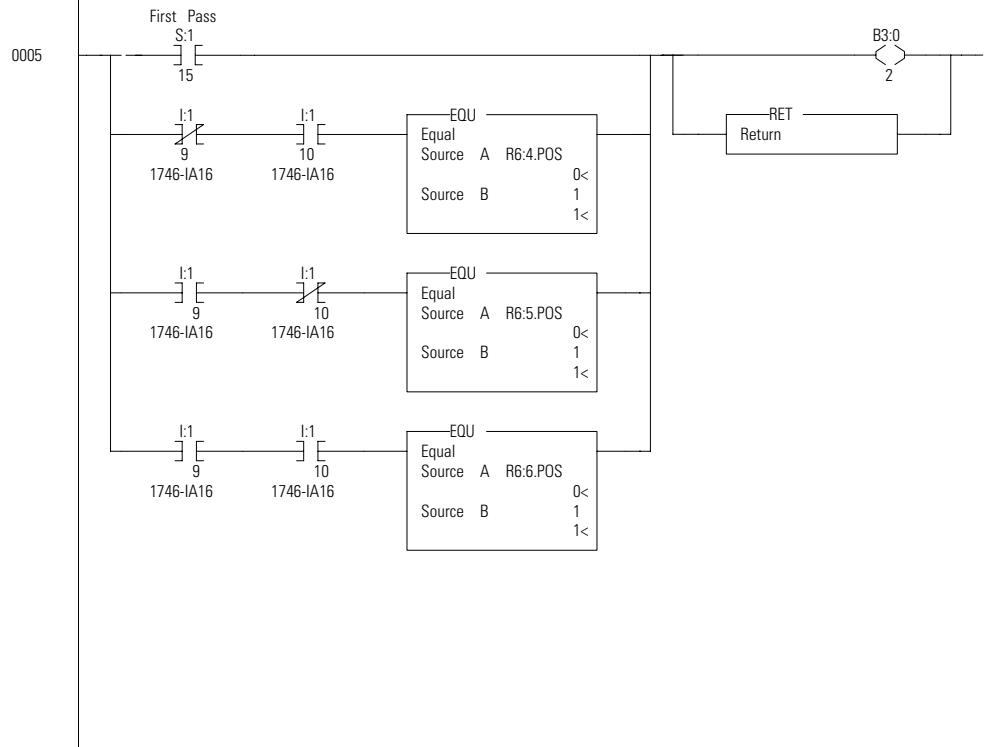



## Drill Calculation and Warning

The program tracks the number of holes drilled and the number of inches of material that have been drilled through using a thumbwheel. The thumbwheel is set to the thickness of the book per 1/4 inch. (If the book is 1 1/2 inches thick, the operator would set the thumbwheel to 6.) When 25,000 inches have been drilled, the Change Drill Soon pilot light turns on. When 25,500 inches have been drilled, the Change Drill Soon pilot light flashes. When 26,000 inches have been drilled, the Change Drill Now pilot light turns on and the machine turns off. The operator changes drill bits and then resets the internal drill wear counter by turning the Drill Change Reset keyswitch.

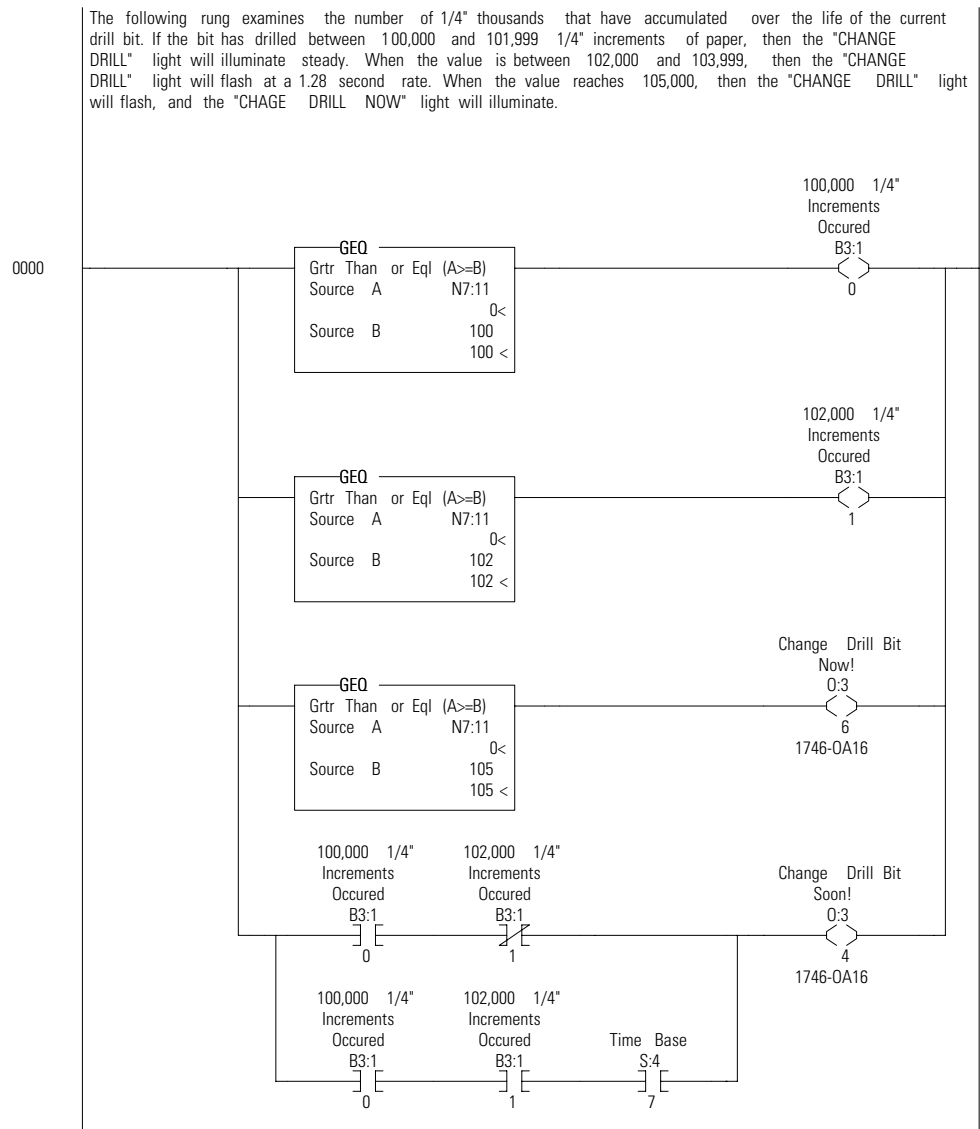



The following rung will reset the number of 1/4" increments and the 1/4" thousands when the "DRILL CHANGE RESET" keyswitch is energized.

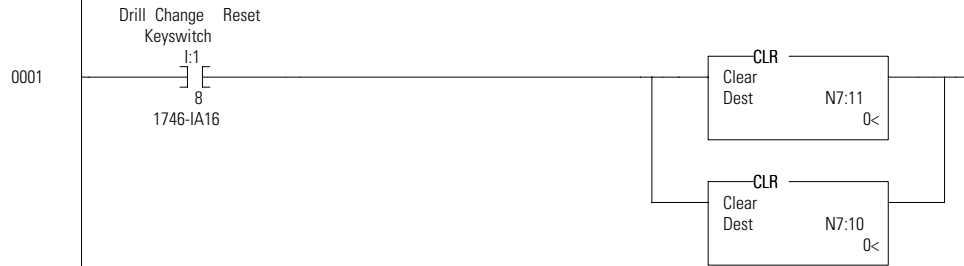

BCD thumbwheel input



The following rung will move the single digit BCD thumbwheel value into an internal integer register. This is done to properly align the four BCD input signals prior to executing the BCD to integer instruction (FRD). The thumbwheel is used to allow the operator to enter the thickness of the paper that is to be drilled. The thickness is entered in 1/4" increments. This provides a range of 1/4" to 2.25"

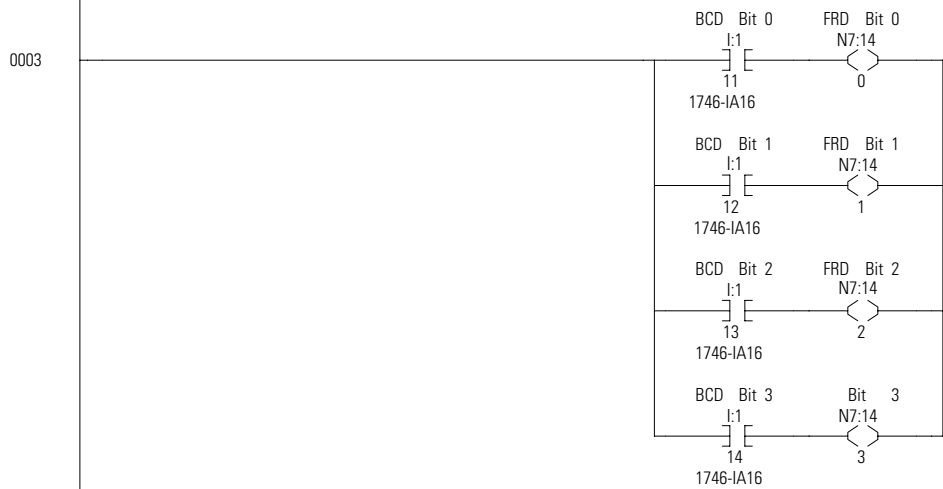

The following rung will convert the BCD thumbwheel value from BCD to integer. This is done because the processor operates upon integer values. This rung also "debounces" the thumbwheel to ensure that conversion only occurs on valid BCD values. Note that invalid BCD values can occur while the operator is changing the BCD thumbwheel. This is due to input filter propagation delay differences between the 4 input circuits that provide the BCD input value.

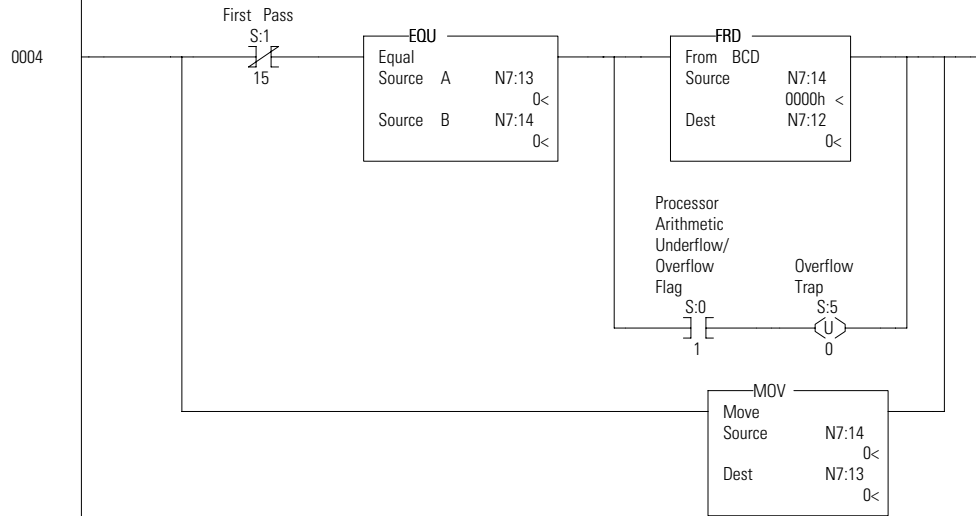

The following rung will ensure that the operator cannot select a paper thickness of 0. If this were allowed, the drill bit life calculation could be defeated resulting in poor quality holes due to a dull drill bit. Therefore the minimum paper thickness that will be used to calculate drill bit wear is ¼".



The following rung will keep a running total of how many inches of paper have been drilled with the current drill bit. Every time a hole is drilled, add the thickness (in 1/4"s) to the running total (kept in 1/4"s). The same OSR is necessary because the ADD will execute every scan that the rung is true, and the drill body would actuate the DRILL DEPTH limit switch for more than 1 program scan. Integer N7:12 is the integer-converted value of the BCD thumbwheel on inputs I:3/11 - I:3/14.

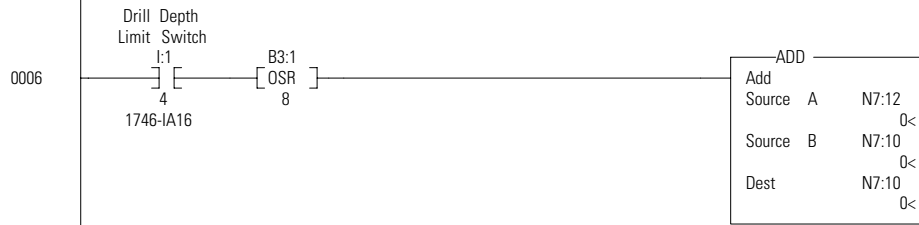

The following rung will keep track of the number of counts that are past 1,000.

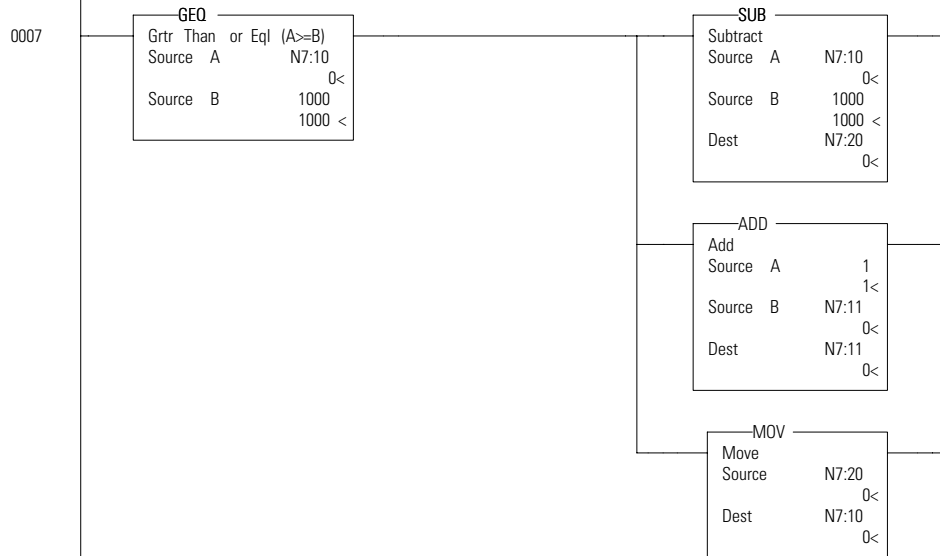

## Time Driven Sequencer Application Example

The following application example illustrates the use of the TON and SQO instructions in a traffic signal at an intersection. The timing requirements are:

- Red light - 30 seconds.
- Yellow light - 15 seconds.
- Green light - 60 seconds.

The timer, when it reaches its preset, steps the sequencer that in turn controls which traffic signal is illuminated. For a detailed explanation of:

- XIC, XIO, and TON instructions, see Chapter 2.
- SQO and SQC instructions, see Chapter 7.

## Time Driven Sequencer Ladder Program

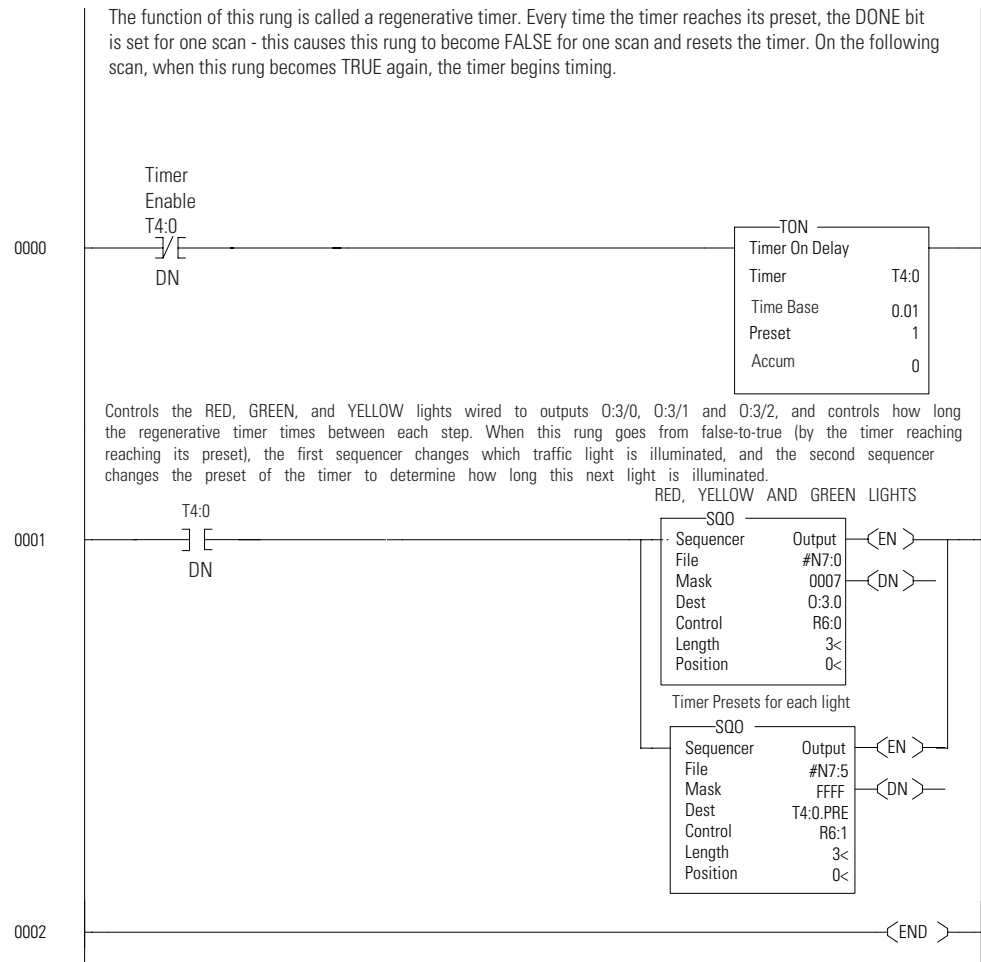

## Event Driven Sequencer Application Example

The following application example illustrates how the FD (found) bit on an SQC instruction can be used to advance as SQO to the next step (position). This application program is used when a specific order of events is required to occur repeatedly. By using this combination, you can eliminate using the XIO, XIC, and other instructions. For a detailed explanation of:

- XIC, XIO, and RES instructions, see Chapter 2.
- SQO and SQC instructions, see Chapter 7.

## Event Driven Sequencer Ladder Program

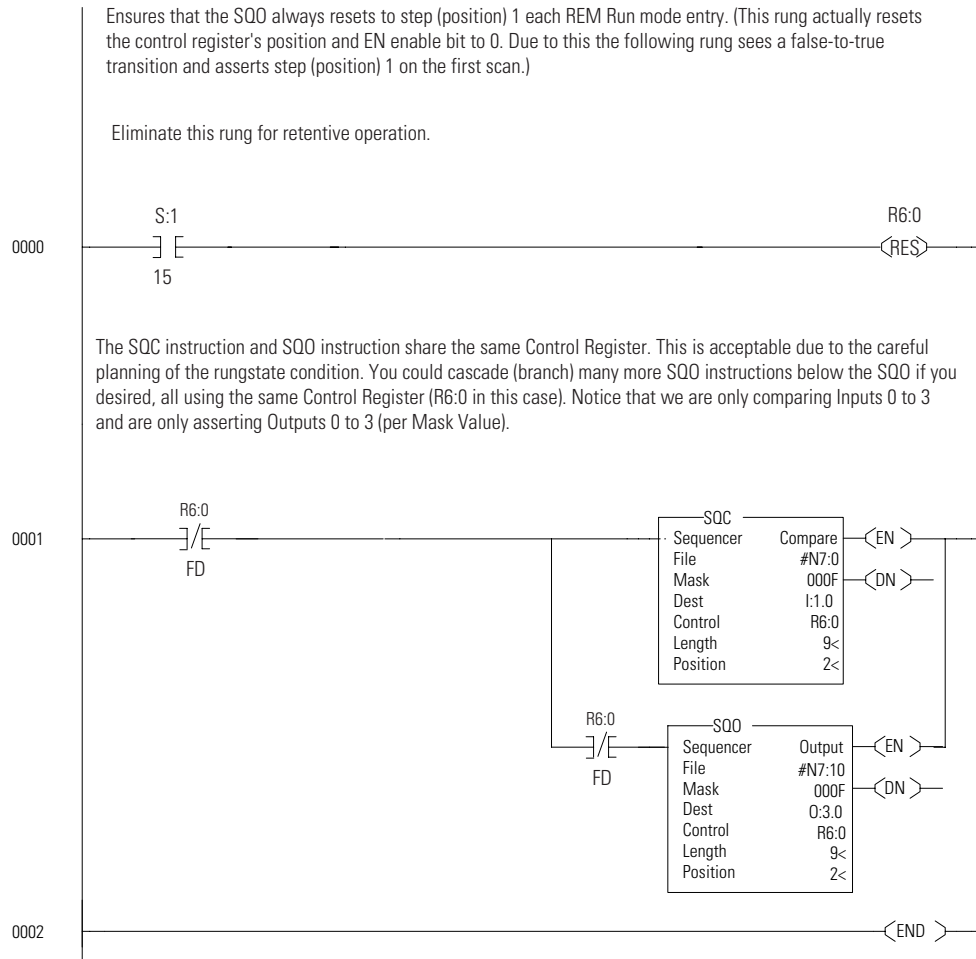

The following table displays the FILE DATA for both sequencers. The SQC compare data starts at N7:9. While the SQO output data starts at N7:10 and ends at N7:19. Please note that the step 0 of the SQO is never active. The reset rung combined with the rung logic of the sequencers guarantees that the sequencers always start at step 1. Both sequencers also roll over to step 1. Roll Over to step 1 is integral to all sequencer instructions.

**Table G.1 SQC Compare Data**

Addresses	Data (Radix = Decimal)									
N7:0	0	1	2	3	4	5	6	7	8	9
N7:10	0	0	1	2	3	4	5	6	7	8

If the high-speed counter reached its high preset of 350 (indicates that the holding area reached maximum capacity), it would energize O:0/0, shutting down the filling operation. Before re-starting the filler, allow the packer to empty the holding area until it is about 1/3 full.

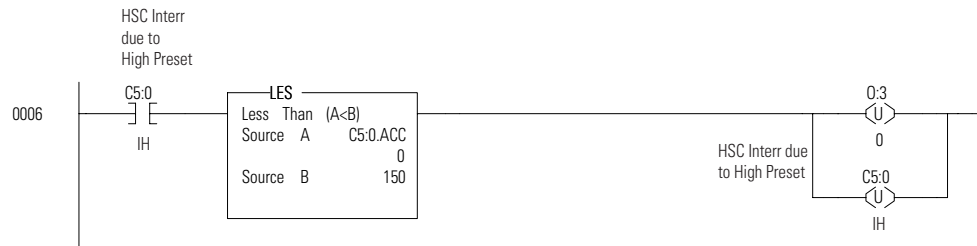

## On/Off Circuit Application Example

The following application example illustrates how to use an input to toggle an output either on or off. For a detailed explanation of:

- XIC, XIO, OTE, OTU, OTL, and OSR instructions, see Chapter 2.
- JMP and LBL instructions, see Chapter 6.

## On/Off Circuit Ladder Program

Does a one-shot from the input push button to an internal bit - the internal bit is true for only one scan. This prevents toggling of the physical output in case the push button is held "ON" for more than one scan (always the case).

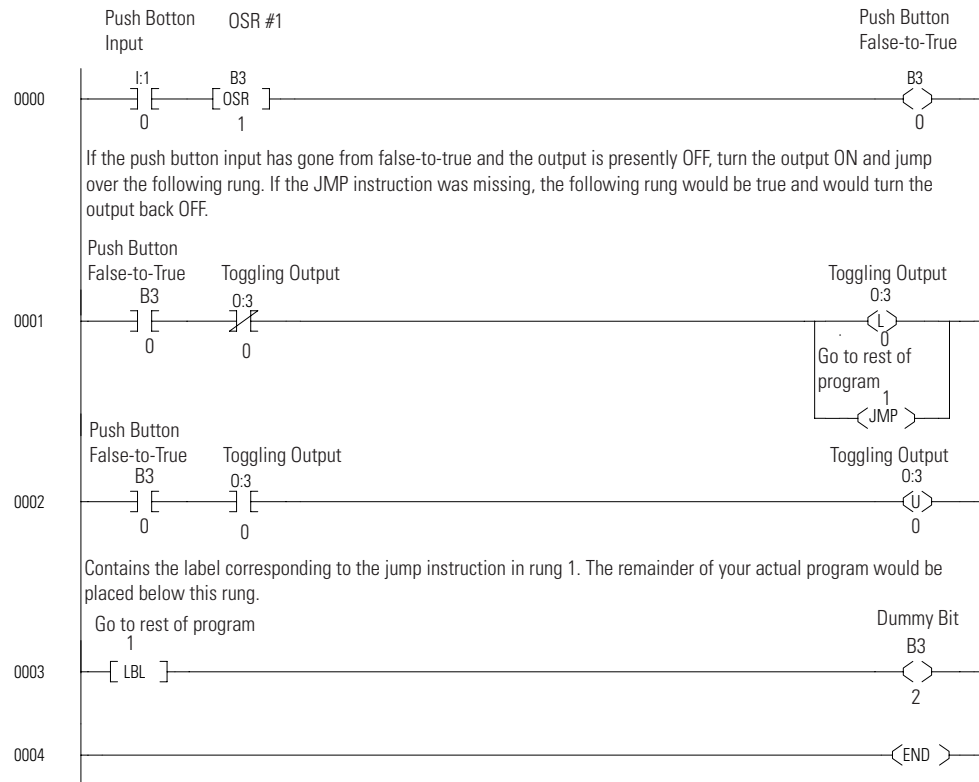

## Interfacing with Enhanced Bar Code Decoders Over DH-485 Network Using the MSG Instruction

The purpose of this section is to illustrate how to interface Allen-Bradley Enhanced Bar Code Decoders to SLC 5/03 and higher processors via the DH-485 network. Enhanced Bar Code Decoders act only as slave devices on this network. This means that these decoders cannot initiate the transfer of data to a host device, such as the SLC 5/03 (or higher) processor on DH-485. The SLC processor must initiate commands to a decoder and poll that decoder for the reply to those commands.

### Processor and Decoder Operation

The Enhanced Bar Code Decoder (catalog number 2755-DS/DD, Series B), when used as a node on a DH-485 network can act as a slave only. This means that the decoder may not initiate communications to any other node on the network. Therefore, in order for a device to get bar code data from an Enhanced Bar Code Decoder on a DH-485 network, that device must send a read command and then poll the decoder for the reply with data.

The only devices capable of polling a slave device on DH-485 are the SLC 5/03 and higher processors. For the SLC 5/03 processors (1747-OS302, FRN10 or later), polling can be done via channels 0 and 1. For the SLC 5/04 processors (1747-OS401, FRN7 or later), channel 0 supports this capability.

There are many ways to trigger bar code decoders to read a bar code label when a label is present.

- A package detect switch wired to both an SLC input module and the bar code decoder
- A package detect switch wired only to an SLC input and an SLC output then used to trigger the decoder
- Via a software trigger command from the SLC processor

For this example, the software trigger is used. However, the basic principal is the same for all trigger modes.

### System Set Up

In this example, a photo switch is located such that when it detects a product is in position for the bar code scanner to read a bar code label on the product, a discrete input to the SLC 5/03 processor is energized.

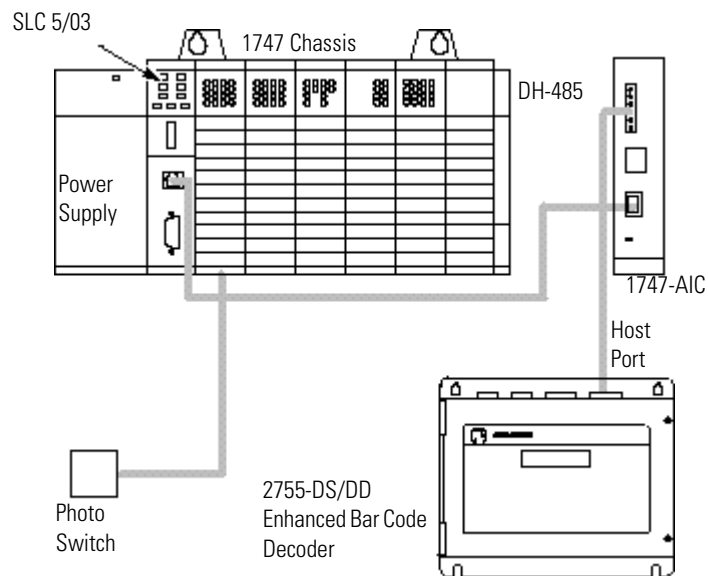

The 5/03 ladder program then initiates a MSG Write to the decoder to trigger the decoder to start scanning for a valid bar code label. When the decoder is scanning for a valid bar code label, it operates as shown below.



**Table G.2 Result of Scanning a Valid Bar code**

<b>Result of Scan</b>	<b>Bar Code Decoder Response</b>	<b>Processor Response</b>
Good Read	turns on its "Good Read" onboard output wired to the SLC processor	When one of these two inputs to the SLC are turned on, the SLC will initiate a "MSG Read" to the decoder to get the label data or no-read message data.
No-Read	turns on its "No-Read" onboard output wired to the SLC processor	

In this case, the good read output is turned on as soon as a valid read occurs, and the no-read output is turned on after the decoder has attempted to read a label for a specified amount of time and could not.

The amount of time the decoder attempts to read a label is variable and is called the "No-Read Timer". For this example it is assumed that the product is moving by the scanner and if the label is not read in 2 seconds, it is not read at all. Therefore, the "No-Read Timer" parameter in the bar code decoder is set to 2 seconds. Refer to the DS/DD Series Enhanced Bar Code Decoders (Bulletin 2755) User's Manual, publication 2755-833, for details concerning the configuration of your Allen-Bradley Enhanced Bar Code Decoder.

## Operating Sequence

With the bar code decoder configured as previously described, the following series of event take place when a product with a good bar code label breaks the photo switch and this input to the SLC goes from false-to-true. The SLC 5/03 ladder program logic to make it happen is also included. Please note that, as previously stated, a bar code/SLC system may be configured in a variety of ways.

Messages sent by the SLC processor to the Enhanced Bar Code Decoder must be programmed as shown by the example ladder program on page H-29. If this logic is not followed, the communication between the two DH-485 devices could become out of sequence, resulting in no data transfers between the decode and the SLC processor. To correct such a problem, cycle power to the decoder.

## Sequence of Events

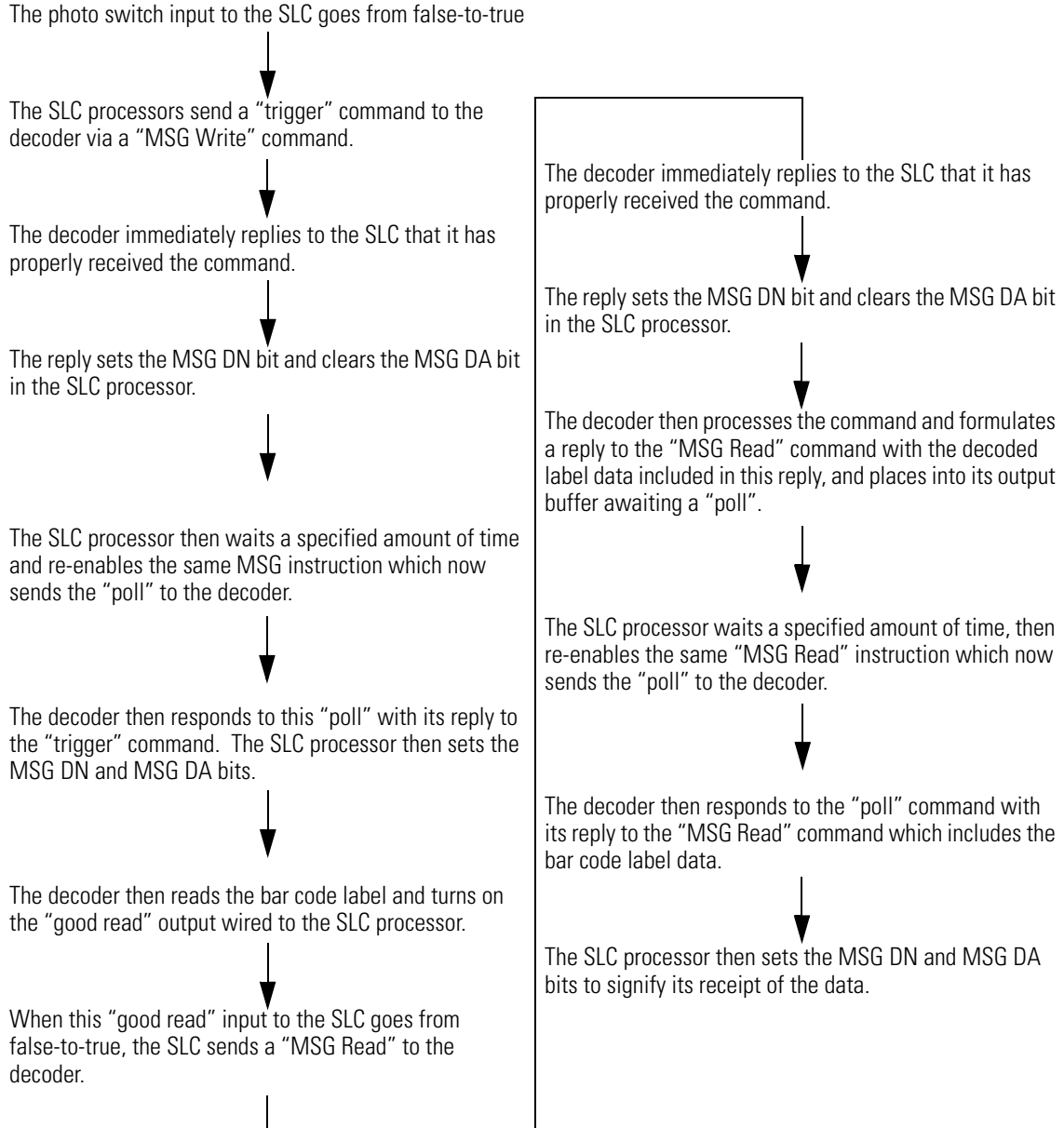

**TIP**

These events are described in more detail by the comments listed within the example ladder program page G-21.

## Optimizing MSG Time-out

If the time delay between sending a command to an Enhanced Bar Code Decoder and polling for the reply is not long enough, the MSG instruction will time-out (MSG TO bit = 1) each time it is enabled from that point forward. To re-synchronize the SLC processor and the decoder, you need to cycle power on the decoder to clear its buffer.

There are ways of clearing the buffers in the decoder, such as sending a Clear Buffers command or a Reset command to the decoder. However, the best way to handle this issue is to never let it happen. Optimizing the time delay between sending the initial command and polling for the reply is the best way to accomplish this. The delay must be long enough so the decoder has enough time to formulate a reply to the command and short enough to not impact the throughput of the application.

## Example MSG Instruction Configuration

The example SLC 5/03 and SLC 5/04 ladder program demonstrates how to send commands to an Enhanced Bar Code Decoder, and then after a time delay, poll for a reply. The internal set up screen parameters for the two MSG instructions in the example ladder program are shown below, along with the necessary Enhanced Bar Code Decoder configuration parameters.

**Table G.3 Message Configuration**

	<b>MSG #1</b>	<b>MSG #2</b>
Type	peer-to-peer	peer-to-peer
Read/write	write	read
Target device	485CIF	485CIF
Local/remote	local	local
Control block	N7:0	N7:20
Channel	1	1
Target node	2	2
Our source file address	N7:15	N7:40
Target CIF offset <sup>(1)</sup>	0	0
Message length in elements	1	10
Message time-out (seconds)	5	5

<sup>(1)</sup> The Target CIF Offset when working with Enhanced Bar Code Decoders as slaves on DH-485 must contain a value greater than 255. However, 255 is the largest value SLC programming software allows you to enter into this parameter in a MSG instruction. Therefore, use an unconditioned rung with a MOV instruction to move the proper value into the Target CIF Offset field. The example ladder program in this section demonstrates this. Note that 1586 decimal in a "MSG Write" is the value which results in a properly configured Enhanced Bar Code Decoder to initiate the "trigger" function. A value of 256 in a "MSG Read" requests a specified number of words of data from the bar code decoder. In this example, we are reading 10 words or 20 characters (bytes).

## Example Scanner and Decoder Configuration

**Table G.4 Scanner and Decoder Configuration**

<b>Scanner Configuration Parameters</b>		<b>2755-DS/DD Series B Enhanced Bar Code Decoder Configuration Parameters</b>	
<b>Scanner Control Page</b>		<b>Host Configurations Page</b>	
Discrete I/O:	Read Package 25 ms No-Read Package 25 ms	Baud Rate:	19200
Laser Light:	Triggered	Bits/Char:	8 Data 1 Stop
Decode Mode:	Host	Parity:	Even
No-Read Time:	2000 ms	Host Protocol:	DH-485 PCCC-1
Inter Scan Time:	none	Device Address:	2
Capture Count:	2	ACK Char:	none
Symbols/Scan:	1	NAK Char:	none
Symbols/Package :	1	Large Buffer:	No
Match Complete:	1	Send Host Message: Package	Immediately after Valid
		Transmission Check:	none

## Example Ladder Program

This rung detects the Photo Switch input going from false-to-true, and latches internal storage bit B3/1.



This rung moves the decimal value for the bar code decoder "trigger" command into the MSG instructions "Offset" parameter. The programming software does not allow values greater than 255 decimal to be entered into a MSG control block "Offset" value.

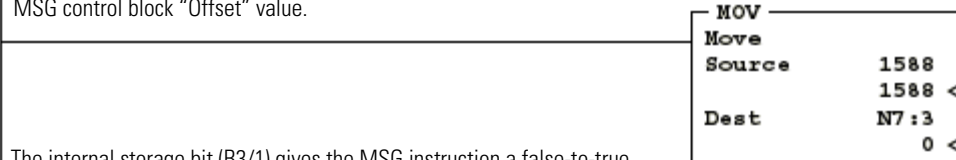

The internal storage bit (B3/1) gives the MSG instruction a false-to-true transition to send the initial command. B3/1 remains latched until both the DN and DA bits are set for the MSG instruction.

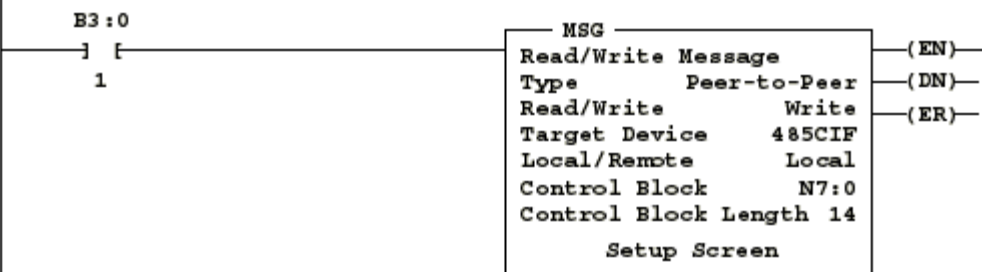

The initial reply from an Enhanced Bar Code Decoder will result in MSG DN = 1 and MSG DA = 0. This simply indicates that the decoder has received the command, but has not yet formulated a reply. The maximum time delay needed between sending the initial command and sending a poll to get the reply is 250 ms. In most cases this delay could be much less (30 ms to 100 ms), depending on the number of features the decoder is configured for.

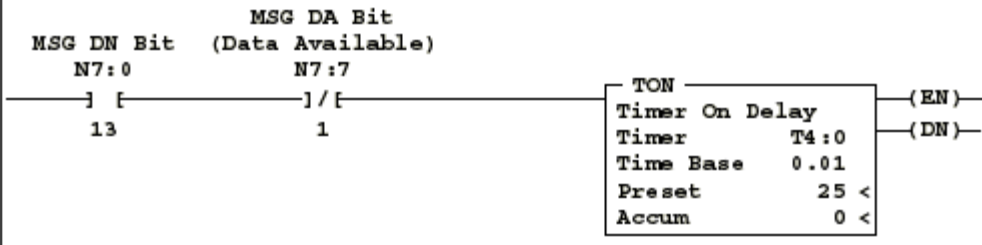

The internal storage bit, B3/1, holds the MSG instruction true until DN and DA are both set, indicating completion of the command sent and reply received sequence. When DN is set and DA is reset, unlatching the MSG EN bit effectively toggles the MSG instruction the same as if the MSG rung were toggled, i.e. rung conditions made false, then true. The MSG instruction is toggled one time after DN and NOT DA plus some time delay, to send a final poll to the decoder to get the MSG reply. When the reply is received, the SLC processor sets DN and DA.

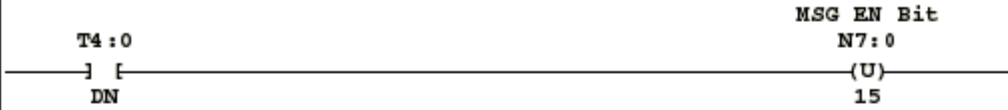

When the SLC processor sets both DN and DA for a MSG instruction, the MSG sequence to an Enhanced Bar Code Decoder is complete. In this case, the decoder has received the "trigger" command and has performed this command. Therefore, unlatch B3/1 at this time to be ready for the next request for "trigger".



If an error occurs with the MSG instruction, the ER bit is set. If this occurs, the user can either try to resend the same message again by unlatching EN, or at this point, could sound an alarm or route the product down a rework loop or some other similar action. If the latter choice is used, you must also unlatch B3/1 at this time to be ready for the next request for "trigger".

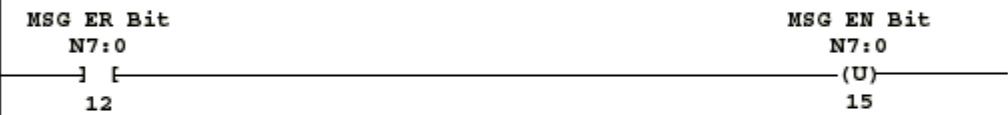

This rung detects false-to-true transitions of either a good read or a no-read input from the bar code decoder and latches internal storage bit B3/2. B3/2 then, in the next rung, initializes the MSG read command to the decoder. This is done if either a good read or a no-read occurs, because the no-read message configured in the decoder is data as much as actual bar code label data. Therefore, the ladder program must distinguish between data that means no-read as well as actual bar code label data.

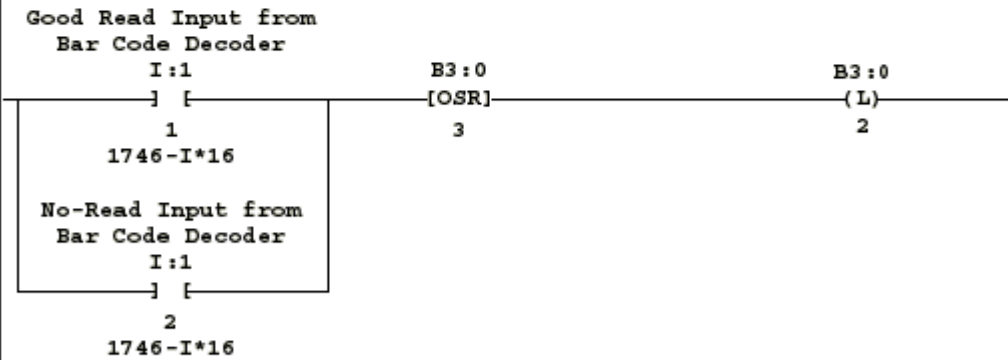

This rung moves the decimal value for the bar code decoder "Read" command into the MSG instruction's "Offset" parameter. The programming software does not allow values greater than 255 decimal to be entered into a MSG control block "Offset" value.

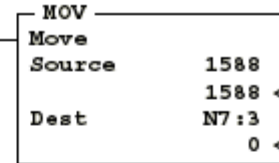

The internal storage bit, B3/2, gives the MSG instruction a false-to-true transition to send the initial command.

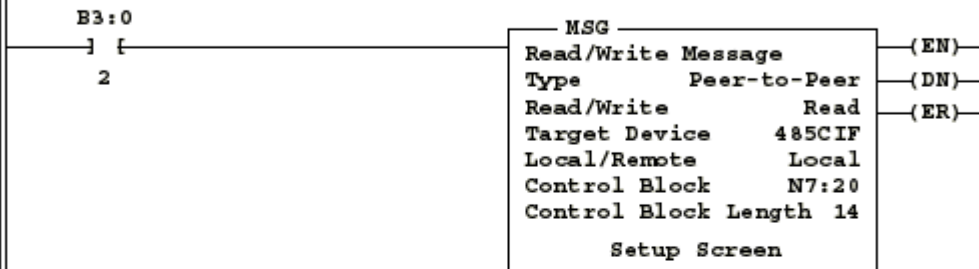

The initial reply from an Enhanced Bar Code Decoder will result in MSG DN = 1 and MSG DA = 0. This indicates that the decoder has received the command, but has not yet formulated a reply. The maximum time delay needed between sending the initial command and sending a poll to get the reply is 250 ms. In most cases this delay could be much less (30 ms to 100 ms), depending on the number of features the decoder is configured for.

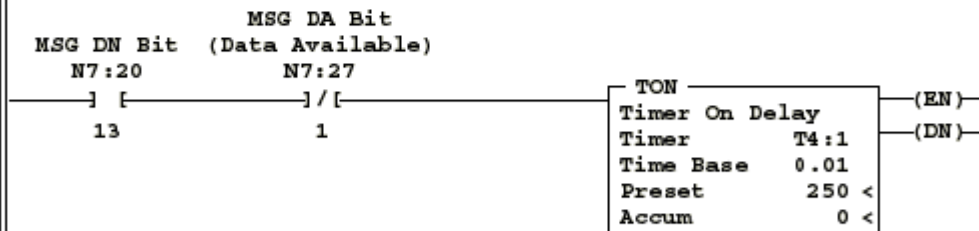

The internal storage bit, B3/2, holds the MSG instruction true until DN and DA are both set, indicating completion of the command sent and reply received sequence. When DN is set and DA is reset, unlatching the MSG EN bit effectively toggles the MSG instruction the same as if the MSG rung were toggled, i.e. rung conditions made false, then true. The MSG instruction is toggled one time after DN and NOT DA plus some time delay, to send a final poll to the decoder to get the MSG reply. When the reply is received, the SLC processor will set DN and DA.

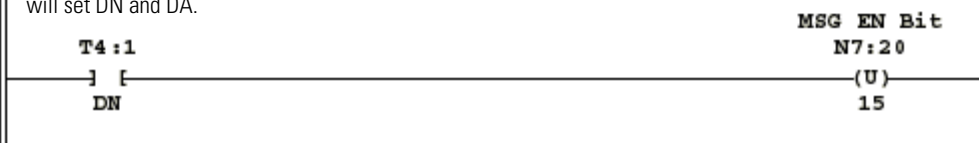





## Supported Read/Write Commands

### Supported Read/Write Commands

This appendix provides the read and write commands that are supported by the SLC 500 Fixed, SLC 5/01, SLC 5/02, SLC 5/03, SLC 5/04, and SLC 5/05 processors. Refer to the DF1 Protocol and Command Set Reference Manual, publication 1770-6.5.16, for additional command details.

**Table H.1 Supported Read/Write Commands**

Command Name	CMD/FNC	SLC 500 Fixed, 5/01	SLC 5/02	SLC 5/03, 5/04, and 5/05
Unprotected Read (485 CIF Read)	01/	respond only	initiates/responds	initiates/responds
Unprotected Write (485 CIF Write)	08/	respond only	initiates/responds	initiates/responds
PLC-5 Word Range Read	0F/00	N/A	N/A	respond only <sup>(1) (2)</sup>
PLC-5 Word Range Write	0F/01	N/A	N/A	respond only <sup>(1) (2)</sup>
PLC-5 Bit Write	0F/02	N/A	N/A	respond only <sup>(1) (2)</sup>
PLC-5 Read-Modify-Write	0F/26	N/A	N/A	respond only <sup>(1) (2)</sup>
PLC-5 Typed Write (PLC5 Write)	0F/67	N/A	N/A	initiates/responds <sup>(2)</sup>
PLC-5 Typed Read (PLC5 Read)	0F/68	N/A	N/A	initiates/responds <sup>(2)</sup>
Protected Typed Logical Read with 2 Address Fields	0F/A1	respond only	respond only	respond only
Protected Typed Logical Read with 3 Address Fields (CPU500 Read)	0F/A2	respond only	initiates/responds	initiates/responds
Protected Typed Logical Write with 2 Address Fields	0F/A9	respond only	respond only	respond only
Protected Typed Logical Write with 3 Address Fields (CPU500 Write)	0F/AA	respond only	initiates/responds	initiates/responds
Protected Typed Logical Write with Mask	0F/AB	respond only	respond only	respond only

<sup>(1)</sup> Series C FRN 6 and higher.

<sup>(2)</sup> Supports both Logical Binary and Logical ASCII Addressing.

**Notes:**

## Numerics

### 5/03 processors

passthru examples 15-3

### 5/04 processors

passthru examples 15-12

### 5/05 processors

BOOTP configuration 13-31  
embedded web server capability 13-35  
passthru examples 15-18

## A

### Absolute (ABS) 4-24

math instruction 4-24

### access denied bit B-13

### ACK timeout

SLC 5/03, 5/04 or 5/05 13-52

### active nodes B-35

### Add (ADD) 4-5

math instruction 4-5

### addressing

defining for SLC 5/03, 5/04, and 5/05  
13-58, 13-66, 13-71

indexed E-10

using mnemonics E-6

### addressing modes D-1, D-2

direct addressing D-2

indexed addressing D-2

indexed indirect addressing D-2

indirect addressing D-2

### And (AND)

updates to arithmetic status bits 5-20

### application specific instructions 7-2

about 7-2

bit shift instructions

overview 7-2

Sequencer Load (SQL)

operation 7-14

### Arc Cosine (ACS) 4-29

math instruction 4-29

### Arc Sine (ASN) 4-29

math instruction 4-29

### Arc Tangent (ATN) 4-30

math instruction 4-30

### arithmetic flags B-5

### ASCII file 10-3

### ASCII Handshake Lines (AHL) 10-13

ASCII instruction 10-13

### ASCII instruction error codes 10-24

### ASCII instruction status bits 10-5

### ASCII instructions

ASCII Handshake Lines (AHL) 10-13

ASCII Read Characters (ARD) 10-15

ASCII Read Line (ARL) 10-17

ASCII String Compare (ASR) 10-19

ASCII Write (AWT) 10-22

ASCII Write with Append (AWA) 10-20

Integer to String (AIC) 10-14

String Concatenate (ACN) 10-11

String Search (ASC) 10-18

timing diagram 10-16

using strings 10-3

### ASCII Read Characters (ARD) 10-15

ASCII instruction 10-15

### ASCII Read Line (ARL) 10-17

ASCII instruction 10-17

### ASCII String Compare (ASR) 10-19

ASCII instruction 10-19

### ASCII string manipulation B-25

### ASCII timing diagram 10-16

### ASCII Write (AWT) 10-22

ASCII instruction 10-22

### ASCII Write with Append (AWA) 10-20

ASCII instruction 10-20

in-line indirection 10-21

## B

### basic instructions 2-2

about 2-2

Examine if Closed (XIC) 2-3

Examine if Open (XIO) 2-3

One-Shot Rising (OSR) 2-5

Output Energize (OTE) 2-4

Output Latch (OTL) 2-4

Output Unlatch (OTU) 2-4

### battery low bit B-24

### baud rate B-39

SLC 5/03, 5/04, and 5/05 13-51, 13-58,  
13-66, 13-71, 13-79

### BCC 13-52, 13-58, 13-66, 13-72, 13-80

### bit file 1-3, E-3

### bit shift instructions E-16

Bit Shift Left (BSL)

operation 7-4

Bit Shift Right (BSR)

operation 7-5

overview 7-2

effects on index register 7-2

### Block Transfer

(BTR and BTW) 8-1

Entering Parameters 8-2

Programming Examples 8-8

RIO Block Transfer Overview 8-2

### BOOTP

configuring SLC 5/05 13-31–13-34  
 using the Rockwell Utility 13-33  
**Broadcast write command** 13-6

## C

**capturing M0-M1 file data** E-24

**carry bit** B-5

**channel 0**

modem lost B-24  
 SLC 5/03, 5/04, and 5/05 full-duplex  
 station 13-50, 13-51, 13-79  
 SLC 5/03, 5/04, and 5/05 remote station  
 13-66, 13-71

**channel configuration**

Modbus RTU Master parameters 13-93

**channel-to-channel passthru** 14-2

**Clear (CLR)** 4-12

math instruction 4-12

**clock/calendar day** B-54

**clock/calendar hours** B-54

**clock/calendar minutes** B-54

**clock/calendar month** B-53

**clock/calendar seconds** B-54

**clock/calendar year** B-53

**common interface file addressing mode**  
 B-15

**common techniques used in this manual**  
 P-2

**communication**

configuring SLC 5/03, 5/04, and 5/05  
 full-duplex station 13-50,  
 13-51, 13-79  
 configuring SLC 5/03, 5/04, and 5/05  
 remote station 13-66, 13-71

**communication information**

Data Highway Plus communication  
 protocol 13-10  
 RS-232 communication protocol (DF1)  
 full-duplex 13-49  
 half-duplex DF1 master/slave proto-  
 col 13-55  
 half-duplex DF1 slave protocol  
 13-55

**communication instructions** 12-1

ControlNet Explicit Message (CEM)  
 12-45

DeviceNet Explicit Message (DEM)  
 12-52

error codes 12-41

EtherNet/IP Explicit Message (EEM)  
 12-58

message instruction (5/02 only) 12-5  
 message instruction (SLC 5/03 and SLC  
 5/04)

configuration options 12-11

control block layout 12-30

entering parameters 12-11

timing diagram 12-37

Service Communications (SVC) 12-3

**communication rate**

SLC 5/03, 5/04, and 5/05 13-51, 13-58,  
 13-66, 13-71, 13-79

**communications active (channel 0)** B-47

**communications active bit** B-7

**communications servicing selection  
 (channel 0)** B-47

**comparison instructions** 3-1

about 3-1

Not Equal (NEQ) 3-2

**Compute (CPT)** 4-25

math instruction 4-25

**configuring**

Minimum DF1 Half-Duplex Master  
 13-61

Minimum Master ACK Timeout 13-62

SLC 5/03, 5/04, and 5/05 13-64

**control file** 1-5, E-3

**control instructions** 6-1

**control line**

SLC 5/03, 5/04, and 5/05 13-51, 13-58,  
 13-66, 13-71, 13-80

**control register error bit** B-22

**ControlNet Explicit Message (CEM)**  
 12-45

**Convert to BCD (TOD)** 5-2

data handling instruction 5-2

**Copy File (COP)**

using 5-13

**Cosine (COS)** 4-30

math instruction 4-30

**Count Down (CTD)**

using status bits 2-15

**Count Up (CTU)** 2-13, 2-14

counter instruction 2-14

using status bits 2-14

**counter accumulator value (.ACC)** 1-7

**counter file** E-3

**counter instructions**

addressing structure 1-7

**counter preset value (.PRE)** 1-7

**counters**

addressing counters 1-7

Count Up (CTU) 2-14

how counters work 2-13  
**CRC** 13-52, 13-58, 13-66, 13-72, 13-80  
**creating data for indexed addresses**  
 E-11  
**crossing file boundaries** E-11, E-15  
**current/last 10 ms scan time** B-19

## D

### **data file organization and addressing**

1-2, E-1  
 bit file 1-3  
 bit shift instructions E-16  
 control file 1-5  
 creating data for indexed addresses  
 E-11  
 crossing file boundaries E-11, E-15  
 data file types E-3  
 data files  
 ASCII file 10-3  
 string file 10-3  
 effects of program interrupt on S24 E-14  
 file copy and file fill instructions E-17  
 file indicator (#) E-15  
 file instructions E-13  
 floating point file 4-4  
 integer file 1-10, 1-11  
 monitoring indexed addresses E-13  
 outputs and inputs 1-2  
 sequencer instructions E-17  
 status file 1-3

### **data file types** E-3

ASCII data file 10-3  
 bit data file 1-3  
 control data file 1-5  
 floating point data file 4-4  
 input data file 1-2  
 integer data file 1-10, 1-11  
 output data file 1-2  
 string data file 10-3

### **data files** E-2

organization E-2  
 types  
 file indicator (#) E-15

### **data handling instructions**

Convert to BCD (TOD) 5-2  
 Decode (DCD) 5-10  
 Encode (ENC) 5-11  
 Encode 1 of 16 to 4 (ENC) 5-11  
 FIFO and LIFO instructions  
 overview 5-25  
 Fill File (FLL) 5-14  
 Radian to Degrees (DEG) 5-8

### **Data Highway Plus communication protocol** 13-10

global status word overview 13-18  
 transmit enable bit 13-19  
 transmit receive bit 13-20  
 using the SLC 5/04 processors 13-22

### **Day-of-Week** B-57

### **Decode (DCD)** 5-10

data handling instruction 5-10

### **DeviceNet Explicit Message (DEM)**

12-52

### **DeviceNet Passthru** 14-2

### **DF1 full-duplex driver** 13-50, 13-51, 13-79

### **DF1 half-duplex driver** 13-66, 13-71

### **DF1 Radio Modem Communications**

13-76

configuring channel 0 13-78

### **DH+ active node table enable bit** B-51

### **DH+ active nodes channel 1** B-59

### **DH-485 active nodes channel 0** B-58

### **DH-485 communication protocol**

DH-485 network initialization 13-5  
 DH-485 token rotation 13-4

### **DH-485 communications servicing selection bit** B-18

### **DH-485 incoming command pending bit** B-15

### **DH-485 message reply pending bit** B-15

### **DH-485 outgoing message command pending bit** B-15

### **diagnostic file** 13-58, 13-66, 13-71

SLC 5/03, 5/04, and 5/05 13-51, 13-79

### **DII accumulator** B-56

### **DII enable bit** B-16

### **DII executing bit** B-16

### **DII lost** B-53

### **DII overflow bit** B-24

### **DII pending bit** B-16

### **direct addressing** D-1

### **Discrete Input Interrupt (DII)** 11-18

application example 11-25  
 basic programming procedure 11-18  
 File Number B-55  
 interrupt latency and interrupt  
 occurrences 11-21  
 interrupt priorities 11-22  
 operation 11-19  
 counter mode 11-19  
 event mode 11-20  
 reconfigurability 11-22

- Slot Number B-55
- subroutine content 11-20
- Discrete Input Interrupt Status File**
  - Accumulator B-56
  - Bit mask B-55
  - Compare Value B-56
  - Down Coun B-56
- displaying values** E-18
- Divide (DIV)** 4-9
  - math instruction 4-9
- Double Divide (DDV)** 4-11
  - math instruction 4-11
- DTR control bit (channel 0)** B-50
- DTR force bit (channel 0)** B-50
- duplicate packet detection**
  - SLC 5/03, 5/04, and 5/05 13-52, 13-59, 13-67, 13-72

## E

- embedded responses**
  - SLC 5/03, 5/04, and 5/05 13-52
- ENC, Encode 1 of 16 to 4** 5-11
- Encode (ENC)** 5-11
  - data handling instruction 5-11
  - updates to arithmetic status bits 5-12
- Encode 1 of 16 to 4 (ENC)** 5-11
  - entering parameters 5-12
- Enhanced PLC-5** 13-63
- ENQ Retries**
  - SLC 5/03, 5/04 or 5/05 13-52
- entering**
  - numeric constants E-18
  - values E-19
- Entering Parameters for BTR and BTW** 8-2
- EOT suppression** 13-59, 13-67, 13-73
- error codes**
  - ASCII instructions 10-24
  - MSG instruction 12-41
- Error detection**
  - SLC 5/03, 5/04, and 5/05 13-52, 13-58, 13-66, 13-72, 13-80
- errors**
  - going-to-run 16-4
  - runtime 16-6
  - user program 16-9
- Ethernet**
  - communication protocol 13-2, 13-22
  - configuration parameters 12-29
  - connections 13-23
  - messaging 13-22

- processor performance 13-22
- SVC instruction 12-3
- EtherNet/IP Explicit Message (EEM)** 12-58
- Examine if Closed (XIC)** 2-3
  - basic instruction 2-3
- Examine if Open (XIO)** 2-3
  - basic instruction 2-3
- Example**
  - active station file 13-63
- Exclusive Or (XOR)**
  - updates to arithmetic status bits 5-22
- Explicit Message Instructions overview** 12-44

## F

- fault override at powerup bit** B-7
- fault routines (SLC 5/02, SLC 5/03, and SLC 5/04)** 11-2
  - application example 11-4
- faults**
  - troubleshooting 16-1
- FIFO and LIFO instructions**
  - overview 5-25
  - effects on index register 5-26
- FIFO Load (FFL)** 5-26
  - FIFO instruction 5-26
- FIFO Unload (FFU)** 5-26
  - FIFO instruction 5-26
- file copy and file fill instructions** E-17
- file indicator (#)** E-15
- file organization**
  - data files E-2
  - program files E-1
- Fill File (FLL)** 5-14
  - data handling instruction 5-14
  - using 5-14
- first pass bit** B-13
- floating point file** 4-4
- floating point math flag disable bit** B-51
- floating point, supported** 3-2
  - Equal (EQU) 3-2
  - Greater Than (GRT) 3-3
  - Greater Than or Equal (GEQ) 3-2
  - Less Than (LES) 3-3
  - Less Than or Equal (LEQ) 3-3
  - Limit (LIM) 3-5
  - Move (MOV) 5-16
- forces enable bit** B-6
- forces installed bit** B-7
- free running clock** B-21

**FRN 10 update** A-19, A-21  
**FRN 6 update** A-13  
**FRN 7 update** A-15  
**FRN 9 update** A-16  
**full-duplex station** 13-51, 13-80

## G

**G data files** E-25  
 editing G file data E-25  
**Global Status File** B-59  
**Global Status Word** 13-19, 13-20  
 overview 13-18  
 status file B-59  
 transmit enable bit 13-19  
 transmit receive bit 13-20  
**going-to-run errors** 16-4

## H

**High-speed Counter (HSC)** 2-15  
 addressing structure 2-16  
 application example 2-18, 2-19  
 counter instruction 2-15

## I

**I/O addressing**  
 for a fixed controller E-6  
 for a modular controller E-8  
**I/O Interrupt Disable (IID)** 11-32  
 I/O interrupt instruction 11-32  
**I/O interrupt executing** B-46  
**I/O interrupts** 11-27  
 basic programming procedure 11-27  
 I/O Interrupt Disable (IID) 11-32  
 interrupt latency and interrupt  
 occurrences 11-28  
 interrupt priorities 11-29  
 operation 11-27  
 subroutine content (ISR) 11-28  
**incoming command pending (channel 0)**  
 B-46  
**index address file range bit** B-14  
**index register** B-43  
**indexed addressing** 4-2, D-1, E-10  
 example E-10  
 specifying E-10  
**indirect addressing** 4-2, 5-16, D-1  
**inline indirection** 10-21  
**input data file** 1-2  
**input file** E-2

**instruction execution times - SLC  
 processors** C-2  
 fixed and SLC 5/01 processors C-2  
 SLC 5/02 processor C-7  
 SLC 5/03, 5/04, and 5/05 processors  
 C-13

**instruction set** D-1  
**integer file** 1-10, 1-11, E-3  
**Integer to String (AIC)** 10-14  
 ASCII instruction 10-14  
**interrupt latency** 11-9, 11-21, 11-25,  
 11-28  
**interrupt latency control bit** B-48

## J

**Jump (JMP)**  
 entering parameters 6-2  
 using 6-2  
**Jump to Subroutine (JSR)** 6-3  
 nesting subroutine files 6-4  
 using 6-4

## L

**Label (LBL)**  
 entering parameters 6-2  
 using 6-3  
**last DII scan time** B-57  
**LEDs** 16-16  
 SLC 5/03 and SLC 5/04 LEDs 16-16  
**load memory module on memory error bit**  
 B-8  
**local message** 15-1  
**Log to the Base 10 (LOG)** 4-31  
 math instruction 4-31  
**logical addresses, specifying**  
 using mnemonics E-6

## M

**M0 and M1 data files** E-19  
 capturing M0-M1 file data E-24  
 minimizing the scan time E-22  
 specialty I/O modules with retentive  
 memory E-24  
 transferring data between processor files  
 E-21  
**M0-M1 referenced or disabled slot bit**  
 B-23  
**major error detected while executing  
 user fault routine bit** B-22

- major error halted bit** B-12
  - manuals, related** P-2
  - Masked Move (MVM)**
    - updates to arithmetic status bits 5-18
  - math instructions** 4-2
    - 32-Bit addition and subtraction 4-6
    - about 4-2
    - Absolute (ABS) 4-24
    - Add (ADD) 4-5
    - Arc Cosine (ACS) 4-29
    - Arc Sine (ASN) 4-29
    - Arc Tangent (ATN) 4-30
    - changes to the math register 4-3
    - Clear (CLR) 4-12
    - Compute (CPT) 4-25
    - Cosine (COS) 4-30
    - Divide (DIV) 4-9
    - Double Divide (DDV) 4-11
    - instruction parameters 4-2
    - Log to the Base 10 (LOG) 4-31
    - Multiply (MUL) 4-8
    - Natural Log (LN) 4-31
    - overflow trap bit 4-3
    - overview 4-2
    - ramp 4-20
    - Scale Data (SCL) 4-15
    - Scale with Parameters (SCP) 4-13
    - Sine (SIN) 4-32
    - Square Root (SQR) 4-12
    - Subtract (SUB) 4-5
    - Swap (SWP) 4-28
    - Tangent (TAN) 4-32
    - updates to arithmetic status bits 4-3
    - using arithmetic status bits 4-5, 4-8, 4-9, 4-11, 4-12, 4-14, 4-16, 4-24, 4-26, 4-29, 4-30, 4-31, 4-32, 4-33, 5-2, 5-5, 5-9, 5-10, 5-12
    - using indexed word addresses 4-2
    - X to the Power of Y (XPY) 4-33
  - math overflow selection bit** 4-6, B-17
  - math register** B-37
  - maximum observed DII scan time** B-57
  - memory module**
    - boot bit B-23
    - data file overwrite protection B-53
    - password mismatch bit B-23
    - program compare B-16
  - memory usage** C-1
    - fixed and SLC 5/01 C-2
    - overview C-1
    - SLC 5/02 C-7
    - SLC 5/03, 5/04, 5/05 C-13
  - message**
    - instruction (SLC 5/02 processor) 12-5
    - instruction error codes 12-41
    - reply pending (channel 0) B-46
    - servicing selection (channel 0) B-47
    - servicing selection (channel 1) B-48
  - messaging examples** 15-1
  - minor error bits** B-21
  - mnemonic, using**
    - in logical addresses E-6
  - Modbus to MicroLogix memory map**
    - 13-96, 13-97
  - modems**
    - dial-up phone 13-84
    - leased-line 13-84
    - line drivers 13-85
    - radio 13-85
  - monitoring index addresses** E-13
  - Move (MOV)**
    - updates to arithmetic status bits 5-17
  - move and logical instructions**
    - changes to the math register 5-17
    - indexed addressing 5-16
    - instruction parameters 5-16
    - updates to arithmetic status bits 5-16
  - MSG Instruction**
    - Parameters 12-11
  - MSG instruction** 13-49
    - for a 5/02
      - communication instruction 12-5
    - for SLC 5/03 and SLC 5/04 processors
      - communication instruction 12-5
  - Multiply (MUL)** 4-8
    - math instruction 4-8
- ## N
- NAK retries**
    - SLC 5/03, 5/04 or 5/05 13-52
  - Natural Log (LN)** 4-31
    - math instruction 4-31
  - Negate (NEG)**
    - updates to arithmetic status bits 5-24
  - nesting subroutine files** 6-4
  - Not (NOT)**
    - updates to arithmetic status bits 5-23
  - Not Equal (NEQ)** 3-2
    - comparison instruction 3-2
  - number systems** E-18
    - binary numbers F-1
    - hex mask F-5
    - hexadecimal numbers F-3



radices used E-18  
**numeric constants** E-18  
**NVRAM size** B-58

## O

**One-Shot Rising (OSR)**  
 entering parameters 2-5  
**operating system** 16-15  
 catalog number B-57  
 downloading 16-15  
 FRN B-57  
 series B-57  
 size B-58  
**Or (OR)**  
 updates to arithmetic status bits 5-21  
**OTL, Output Latch** 2-4  
**OTU, Output Unlatch** 2-4  
**outgoing message command pending (channel 0)** B-46  
**output data file** 1-2  
**Output Energize (OTE)** 2-4  
 basic instructions 2-4  
**output file** E-2  
**Output Latch (OTL)** 2-4  
 using 2-4  
**Output Unlatch (OTU)** 2-4  
 using 2-5  
**overflow bit** B-5  
**overflow trap bit** 4-3, B-22  
**overview**  
 FIFO and LIFO instructions 5-25

## P

**parity**  
 SLC 5/03, 5/04, and 5/05 13-51, 13-58, 13-66, 13-71, 13-79  
**Passthru**  
 channel-to-channel 14-2  
 DeviceNet 14-2  
 disabled bit B-51  
 remote I/O 14-1  
 SLC 5/03 error codes 14-7  
 SLC 5/03 example 15-3  
 SLC 5/04 examples 15-12  
 SLC 5/05 error codes 14-13  
 SLC 5/05 examples 15-18  
**performance**  
 Ethernet processor 13-22  
**point-to-point** 13-50, 13-51, 13-79  
**Poll timeout** 13-59, 13-67

**processor catalog number** B-57

### processor files

organization E-1  
 overview E-1  
 data files E-2  
 program files E-2

**processor revision** B-58

**program constants** E-18

### program file

memory structure 1-1

**program files** E-1, E-2

**program flow control instructions** 6-1

about 6-1  
 Jump to Subroutine (JSR) 6-3  
 Return (RET) 6-3  
 Subroutine (SBR) 6-3

**program functionality index** B-58

**program type** B-58

**Proportional Integral Derivative instruction (PID)**

application notes 9-27  
 PID and Analog I/O scaling 9-23  
 using the SCL instruction 9-24  
 using the SCP instruction 9-24  
 runtime errors 9-21  
 the PID concept 9-1  
 the PID equation 9-2

**publications, related** P-2

## R

**Radian to Degrees (DEG)** 5-8

data handling instruction 5-8

**Ramp (RMP)** 4-20

**ramp equation** 4-23

**Read Program Checksum (RPC)** 7-23

**related publications** P-2

**remote examples** 15-25

**Remote I/O Passthru** 14-1

**remote message** 15-1

### Remote station

available modes for SLC 5/03, 5/04, and 5/05 13-58, 13-66, 13-71  
 configuring SLC 5/03, 5/04, and 5/05 13-66, 13-71  
 SLC 5/03, 5/04, and 5/05 configuration 13-64

**remote station driver**

SLC 5/03, 5/04, and 5/05 13-66, 13-71

**remote terminology**

remote bridge address 15-2  
 remote bridge link ID 15-2

- remote station address 15-2
- reserved** B-6, B-22, B-23, B-53, B-59
- Reset (RES)** 2-20
- Retentive Timer (RTO)**
  - using status bits 2-12
- retries**
  - SLC 5/03, 5/04, and 5/05 13-59, 13-67, 13-73
- Return (RET)** 6-3
  - nesting subroutine files 6-4
  - using 6-5
- Return from Subroutine (RET)** 6-5
  - program flow instruction 6-5
- RIO Block Transfer Overview** 8-2
- RTS off delay** 13-59, 13-67, 13-72, 13-89
- RTS send delay** 13-59, 13-67, 13-72, 13-89
- runtime errors** 16-6

## S

- saved with single step test enabled bit** B-14
- Scale Data (SCL)** 4-15
  - math instruction 4-15
- Scale with Parameters**
  - math instruction 4-13
- Scale with Parameters (SCP)** 4-13
- scan time timebase selection** B-50
- scan toggle bit** B-48
- Selectable Timed Disable (STD)** 11-16
  - interrupt instruction 11-16
- selectable timed interrupt** 11-8
  - basic programming procedure 11-8
  - enable bit B-14
  - executing bit B-14
  - file number B-45
  - interrupt latency and interrupt occurrences 11-9
  - interrupt priorities 11-11
  - operation 11-9
  - overflow bit B-23
  - pending bit B-13
  - Selectable Timed Disable (STD) 11-16
  - setpoint B-45
  - subroutine content 11-9
- selection status (channel 0)** B-47
- sequencer instructions** E-17
  - entering parameters for SQL 7-12
  - entering parameters for SQO and SQC 7-6
  - overview
    - effects on index register 7-5
    - Sequencer Load (SQL) 7-12
    - Sequencer Output (SQO)
      - operation 7-8
- Sequencer Load (SQL)** 7-12
  - application specific instruction 7-12
- Service Communications (SVC)** 12-3
  - communication instruction (5/02 only) 12-3
- sign bit** B-6
- Sine (SIN)** 4-32
  - math instruction 4-32
- SLC 5/03, 5/04, and 5/05**
  - Active stations, monitoring 13-63
  - Channel Status 13-68
  - Configuring
    - Channel 0 Poll Timeout 13-73
    - DF1 Half-Duplex Master - Message-based 13-63
    - DF1 Half-Duplex Master - Standard Mode 13-56
    - Point-to-point 13-7, 13-12, 13-24
    - DF1 Full-Duplex
      - Channel Status 13-9, 13-13, 13-28, 13-53, 13-81
- SLC 5/05 passthru examples** 15-18
- Square Root (SQR)** 4-12
  - math instruction 4-12
- startup protection fault bit** B-7
- Station address**
  - SLC 5/03, 5/04, and 5/05 13-58, 13-66, 13-71
- station list**
  - viewing 13-63
- status data file** E-3
- status file** B-1
  - conventions used in the displays B-4
- STI lost** B-53
- STI resolution selection bit** B-16
- String Concatenate (ACN)** 10-11
  - ASCII instruction 10-11
- string file** 10-3
- String Search (ASC)** 10-18
  - ASCII instruction 10-18
- Subroutine (SBR)** 6-3
  - nesting subroutine files 6-4
  - using 6-5
- Subtract (SUB)** 4-5
  - math instruction 4-5
- Swap (SWP)** 4-28
  - math instruction 4-28

**T**

- Tangent (TAN)** 4-32
  - math instruction 4-32
- test single step**
  - breakpoint B-40
  - start step on B-40
- test-fault/powerdown** B-41
- timer accumulator value (.ACC)** 2-7
- timer accuracy** 2-8
- timer and counter instructions** 1-5
  - accumulator value (.ACC) 1-7, 2-7
  - addressing structure 1-5
  - counters
    - Count Up (CTU) 2-13, 2-14
    - High-Speed Counter (HSC) 2-15
    - Reset (RES) 2-20
  - how counters work 2-13
  - preset value (.PRE) 2-7
  - timebase 2-8
  - timer accuracy 2-8
- timer file** E-3
- timer instructions**
  - addressing structure 1-5
- Timer Off-Delay (TOF)**
  - using status bits 2-10
- Timer On-Delay (TON)**
  - using status bits 2-9
- timer preset value (.PRE)** 2-7
- timer timebase** 2-8
- timers**
  - timer accuracy 2-8
- timing diagrams**
  - ASCII 10-16
  - message instruction (SLC 5/03 and SLC 5/04) 12-37
- TOD (convert from BCD)** 5-2
- troubleshooting faults** 16-1

- clearing faults
  - automatically 16-1
  - manually 16-2
- going-to-run errors 16-4
- processor LEDs 16-15
- runtime errors 16-6
- user program instruction errors 16-9

**U**

- understanding file organization** E-1
  - numeric constants E-18
  - processor file overview E-1
  - specifying indexed addresses E-10
  - using the file indicator (#) E-15
- user program errors** 16-9
- user word comparison between SLC 5/03 and SLC 5/02** C-12
- using RSLinx Classic, version 2.50 and higher with**
  - SLC 5/03 passthru 14-5
  - SLC 5/04 passthru 14-8
  - SLC 5/05 passthru 14-11

**W**

- watchdog scan time byte** B-20

**X**

- X to the Power of Y (XPY)** 4-33
  - math instruction 4-33
- XIC, Examine if Closed** 2-3
- XIO, Examine if Open** 2-3

**Z**

- zero bit** B-5



## SLC 500 Alphabetical List of Instructions

<b>Instruction</b>	<b>Page</b>	<b>Instruction</b>	<b>Page</b>	<b>Instruction</b>	<b>Page</b>
ABL - Test Line for Buffer	10-6	ENC - Encode 1 of 16 to 4	5-11	PID - Proportional/Integral/Differential	9-3
ABS - Absolute	4-24	EQU - Equal	3-2	RAD - Degrees to Radians	5-9
ACB - Number of Characters In Buffer	10-7	FBC - File Bit Comparison	7-18	REF - I/O Refresh	6-10
ACI - String to Integer	10-8	FFL - FIFO Load	5-26	RES - Reset	2-20
ACL - ASCII Clear Receive and/or Send Buffer	10-9	FFU - FIFO Unload	5-26	RET - Return	6-3
ACN - String Concatenate	10-11	FLL - Fill File	5-13	RHC - Read High-speed Clock	7-17
ACS - Arc Cosine	4-29	FRD - Convert from BCD	5-5	RMP - Ramp	4-20
ADD - Add	4-5	GEQ - Greater Than or Equal	3-4	RPC - Read Program Checksum	7-23
AEX - String Extract	10-12	GRT - Greater Than	3-3	RPI - Reset Pending Interrupt	11-34
AHL - ASCII Handshake Lines	10-13	HSC - High-speed Counter	2-15	RTO - Retentive Timer	2-11
AIC - Integer to String	10-14	IID - I/O Interrupt Disable	11-32	SBR - Subroutine	6-3
AND - And	5-20	IIE - I/O Interrupt Enable	11-32	SCL - Scale Data	4-15
ARD - ASCII Read Characters	10-15	IIM - Immediate Input with Mask	6-8	SCP - Scale with Parameters	4-13
ARL - ASCII Read Line	10-17	INT - Interrupt Subroutine	11-34	SIN - Sine	4-32
ASC - String Search	10-18	IOM - Immediate Output with Mask	6-9	SQC - Sequencer Compare	7-6
ASN - Arc Sine	4-29	JMP - Jump	6-2	SQL - Sequencer Load	7-12
ASR - ASCII String Compare	10-19	JSR - Jump to Subroutine	6-3	SQO - Sequencer Output	7-6
ATN - Arc Tangent	4-30	LBL - Label	6-2	SQR - Square Root	4-12
AWA - ASCII Write with Append	10-20	LEQ - Less Than or Equal	3-3	STD - Selectable Timed Disable	11-16
AWT - ASCII Write	10-22	LES - Less Than	3-3	STE - Selectable Timed Enable	11-16
BSL - Bit Shift Left	7-4	LFL - LIFO Load	5-28	STI - Selectable Timed Interrupt	11-12
BSR - Bit Shift Right	7-4	LFU - LIFO Unload	5-28	STS - Selectable Timed Start	11-17
BTR - Block Transfer Read	8-1	LIM - Limit Test	3-5	SUB - Subtract	4-5
BTW - Block Transfer Write	8-1	LN -Natural Log	4-31	SUS - Suspend	6-8
CEM - ControlNet Explicit Message	12-45	LOG - Log to the Base 10	4-31	SVC - Service Communications	12-3
CLR - Clear	4-12	MCR - Master Control Reset	6-6	SWP - Swap	4-28
COP - Copy File	5-13	MEQ - Masked Comparison for Equal	3-4	TAN - Tangent	4-32
COS - Cosine	4-30	MOV - Move	5-17	TDF - Compute Time Difference	7-17
CPT - Compute	4-25	MSG - Message	12-5	TND - Temporary End	6-7
CTD - Count Down	2-14	MUL - Multiply	4-8	TOD - Convert to BCD	5-2
CTU - Count Up	2-13	MVM - Masked Move	5-18	TOF - Timer Off-delay	2-10
DEM - DeviceNet Explicit Message	12-52	NEG - Negate	5-24	TON - Timer On-delay	2-9
DCD - Decode 4 to 1 of 16	5-10	NEQ - Not Equal	3-2	XIC - Examine if Closed	2-3
DDT - Diagnostic Detect	7-18	NOT - Not	5-23	XIO - Examine if Open	2-3
DDV - Double Divide	4-11	OR - Or	5-21	XOR - Exclusive Or	5-22
DEG - Radian to Degrees	5-8	OSR - One-shot Rising	2-5	XPY - X to the Power of Y	4-33
DII - Discrete Input Interrupt	11-23	OTE - Output Energize	2-4		
DIV - Divide	4-9	OTL - Output Latch	2-4		
EEM - Ethernet/IP Explicit Message	12-58	OTU - Output Unlatch	2-4		

# Rockwell Automation Support

Rockwell Automation provides technical information on the Web to assist you in using its products. At <http://support.rockwellautomation.com>, you can find technical manuals, a knowledge base of FAQs, technical and application notes, sample code and links to software service packs, and a MySupport feature that you can customize to make the best use of these tools.

For an additional level of technical phone support for installation, configuration and troubleshooting, we offer TechConnect Support programs. For more information, contact your local distributor or Rockwell Automation representative, or visit <http://support.rockwellautomation.com>.

## Installation Assistance

If you experience a problem with a hardware module within the first 24 hours of installation, please review the information that's contained in this manual. You can also contact a special Customer Support number for initial help in getting your module up and running:

United States	1.440.646.3434 Monday – Friday, 8am – 5pm EST
Outside United States	Please contact your local Rockwell Automation representative for any technical support issues.

## New Product Satisfaction Return

Rockwell tests all of its products to ensure that they are fully operational when shipped from the manufacturing facility. However, if your product is not functioning and needs to be returned, follow these procedures:

United States	Contact your distributor. You must provide a Customer Support case number (see phone number above to obtain one) to your distributor in order to complete the return process.
Outside United States	Please contact your local Rockwell Automation representative for the return procedure.

PLC-2, PLC-3, PLC-5, SLC, SLC 500, DH+, DAa Highway Plus, RSLogix 500, RSLinx, RSLinx Classic, Allen-Bradley, and Rockwell Automation are trademarks of Rockwell Automation, Inc.  
Trademarks not belonging to Rockwell Automation are property of their respective companies.

[www.rockwellautomation.com](http://www.rockwellautomation.com)

### Power, Control and Information Solutions Headquarters

Americas: Rockwell Automation, 1201 South Second Street, Milwaukee, WI 53204-2496 USA, Tel: (1) 414.382.2000, Fax: (1) 414.382.4444

Europe/Middle East/Africa: Rockwell Automation, Vorstlaan/Boulevard du Souverain 36, 1170 Brussels, Belgium, Tel: (32) 2 663 0600, Fax: (32) 2 663 0640

Asia Pacific: Rockwell Automation, Level 14, Core F, Cyberport 3, 100 Cyberport Road, Hong Kong, Tel: (852) 2887 4788, Fax: (852) 2508 1846